

An aerial photograph of a river meandering through a lush, dense green forest. The river is dark and reflects the surrounding trees. The text is overlaid on the upper half of the image.

**2022**  
**FISHING TACKLE CATALOGUE**

**SHIMANO**



# WELCOME...

Welcome to our Shimano 2022 European product range. It is fitting that after celebrating our centenary anniversary last year, we have started the next chapter of our history with the largest, most exciting product line-up Shimano have ever offered. Star of the show for 2022 is undoubtedly the new Stella. When first launched over a generation ago, it dramatically changed the history of spinning reels and continues to evolve as an all-time star that leads other models. With a reputation for containing Shimano's latest and most advanced technologies, the exquisite new Stella certainly doesn't disappoint with its 'Infinity Evolution' tag line.

There is a selection of remarkable technologies on Shimano's latest innovation: INFINITYDRIVE, plus the new INFINITYXROSS and INFINITYLOOP work harmoniously to enhance gearing, casting and rotational performance to a level of refinement and sensitivity that will astound you. Combined with a new line management technology called ANTI-TWIST FIN and a new DURACROSS drag design, the new Stella takes spinning reel evolution to new heights. But, Shimano has so much more to offer.

While our enviable reputation for innovation and prestige originated with reels like the Stella, in recent years our rods and accessories have also gained favour with millions of anglers as our product range has developed and increased. As you will see through this catalogue, Shimano now offer complete 'lifestyle' solutions in

almost all angling disciplines and at all levels of expertise.

Those of you who fish with Shimano will know the feeling of trust, confidence and enjoyment that excellence brings: the ultra-smooth, whisper-quiet rotation of a reel; the sensitivity, balance and power of a rod; the strength of a line when you need it most; the practicality of well-made tackle storage; and the catching power of your favourite go-to lure. These products are not only inspirational in their design, but aspirational in their ownership.

For many years 'Closer to Nature, Closer to People' has been at the heart of the Shimano philosophy. Whilst technology, innovation and manufacturing excellence is passed on to the next generation through our DNA, we never lose sight of our true purpose of producing captivating products to enrich your enjoyment of fishing and the nature that surrounds you. And with the health benefits of angling now widely accepted and acknowledged, what better way to enjoy yourself than with Shimano by your side.

Welcome to 2022 and a product range that is sure to impress and excite you. From everyone at Shimano we wish you excitement, enjoyment and happiness whenever and wherever you fish.

**Warren Bassett**, Managing Director - SHIMANO Europe Fishing Division



# CONTENTS

## REELS

4	REEL TECHNOLOGY
8	FRONT DRAG
34	REAR DRAG
38	BIG PIT
52	FREESPOOL
60	BAITCASTING
82	SALTWATER
92	MULTIPLIER
100	ELECTRIC
104	REEL MAINTENANCE
106	REEL TECNOLOGY
108	REEL SPECIFICATIONS

## RODS

114	ROD TECHNOLOGY
118	FRESHWATER PREDATOR
154	TROUT
160	TRAVEL
168	SPECIMEN
182	MATCH & FEEDER
194	TELESCOPIC
202	SALTWATER PREDATOR
220	BOAT
234	SURF
242	FLY
250	ROD TECHNOLOGY

## ACCESSORIES

252	LUGGAGE
274	LINE
286	CLOTHING & EYEWEAR
296	LURES
324	ISOLATE BAIT



# HAGANE

## OUR GOAL, ETERNALLY SMOOTH REELING

REEL MANUFACTURING BASED ON THE HAGANE CONCEPT IS SUPPORTED BY THE UNIQUE METALWORKING TECHNOLOGY THAT SHIMANO HAS DEVELOPED OVER THE YEARS.



### HAGANE GEAR

The HAGANE Drive Gear is produced by SHIMANO's cold forging technology, without the need for additional machining. This results in gearing parts which retain the characteristics of the pure material, keeping it as strong as possible.

#### BENEFIT

This delivers a long lasting smoothness, strength, lightness and power at the very heart of the reel. Traditional die cast machined gears are less durable under heavy loads, but HAGANE Gear is tremendously strong and durable.

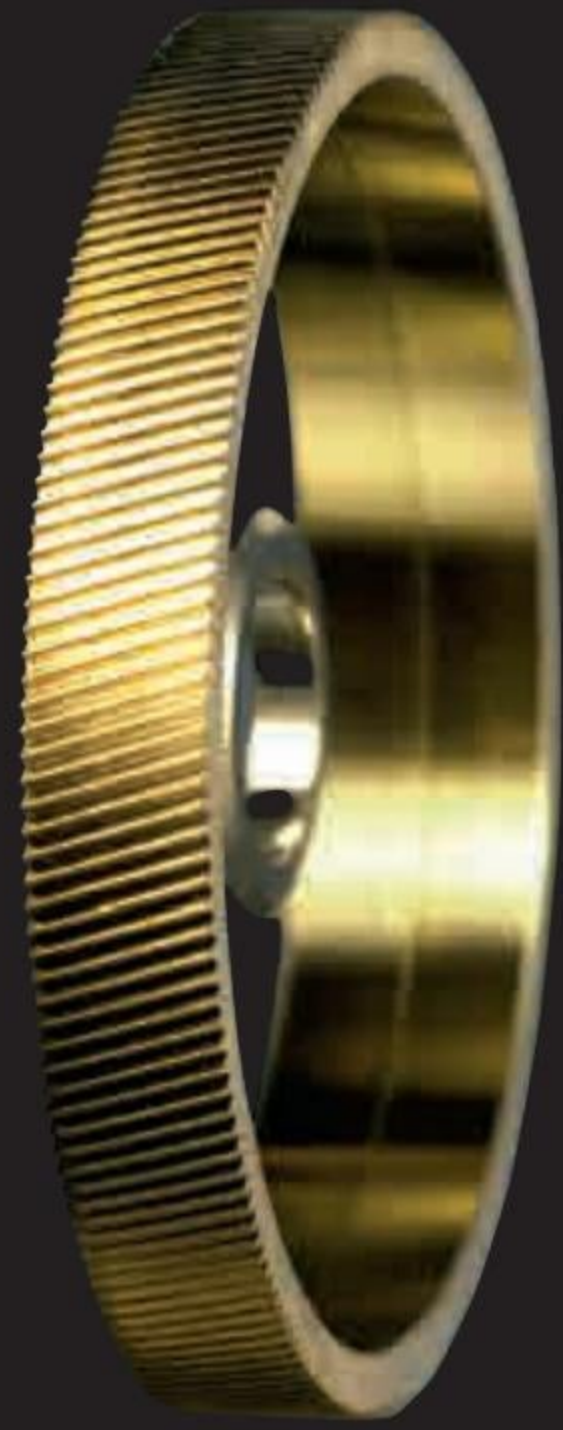

### MICROMODULE GEAR

MICROMODULE GEAR is a machined gear component, made with great precision. The super-refined teeth produce seamless engagement with other gears.

#### BENEFIT

MICROMODULE GEAR has two advantages: increased smoothness and better sensitivity. This results in accurate performance with improved power transmission.

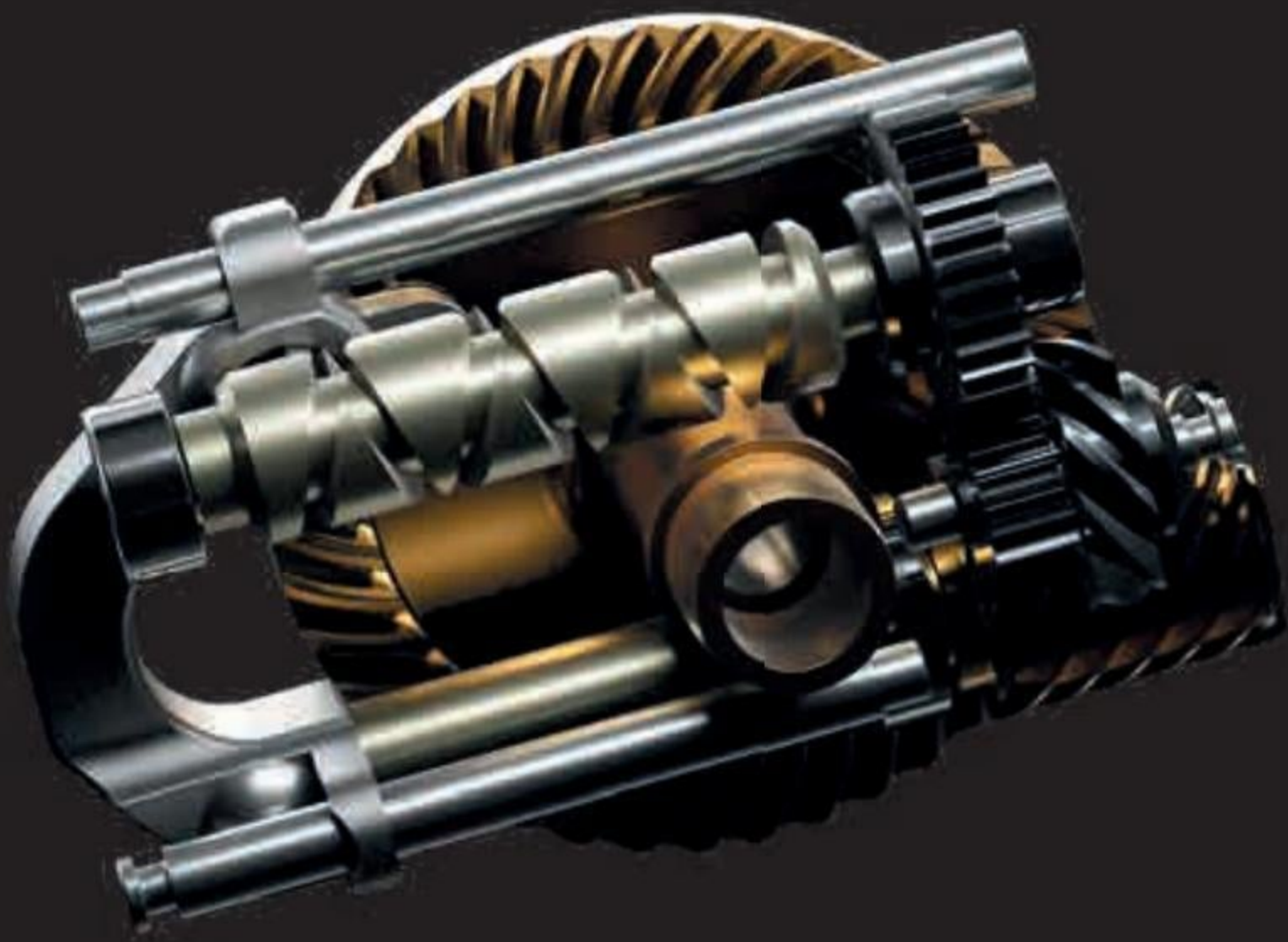

### X-SHIP

X-SHIP stands for Extra Smooth & High Power. It is a precision gearing system which enables smooth yet strong reeling. By supporting the pinion gear at both ends and integrating a bigger drive gear with improved positioning, increased gearing efficiency and power is produced. It results in ultra-light handle rotation combined with excellent power efficiency.

#### BENEFIT

This enhances the smooth operation of the reel, while at the same time improving power transmission from the handle to the rotor. This means less effort and more power - giving a perfect rotation, even under heavy loads and high pressure. The X-SHIP components are strong, precise and durable.



### HAGANE BODY

HAGANE BODY is made out of precision machined aluminium or magnesium. These body designs create stiffness and impact resistance, while at the same time eliminating flexing of the body. The HAGANE BODY is highly rigid and protects gear rotation performance from heavy loads and shocks.

#### BENEFIT

The high rigidity makes the reel body very strong, tough and protects the gears and inner workings. At the same time, the body has a low weight and minimal flex, warp or distortion. The result is a rock-solid housing and support for the moving internal gearing and greater efficiency throughout the reel. This helps increase smoothness and powerful reeling.

## BODY TECHNOLOGY



**CI4+**

### CI4+

A CI4+ Body is made out of CI4+ composite material with very special characteristics. It is stronger than the original CI4 and XT-7 graphite, and also lighter in weight. Because CI4+ does not contain any metal, it is not affected by corrosion, making it suitable for salt water use. CI4+ parts are lighter and stronger than any other composite material SHIMANO uses in their products.

#### BENEFIT

The application of a CI4+ Body results in a lightweight yet strong reel, which is corrosion resistant. Reels with a CI4+ body are ideal for lure fishing, when continuous casting is required, and also for salt water inshore situations where corrosion may be a problem over time.

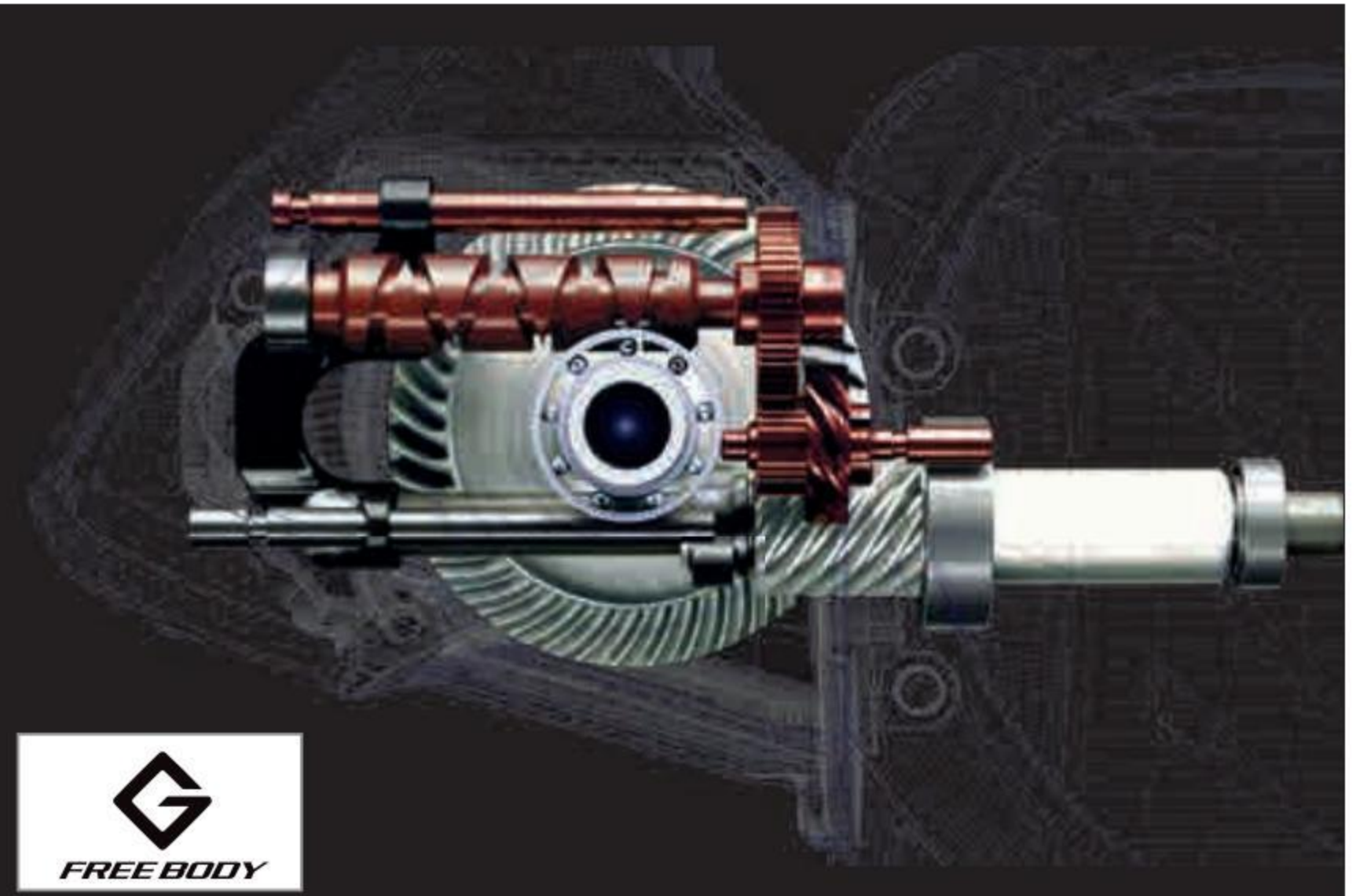

**FREE BODY**

### G FREE BODY

G Free Body technology has been developed to shift the reel's centre of gravity closer to the rod. This has been achieved by moving the oscillation mechanism more towards the top of the reel. By moving the centre of gravity closer to the angler's hand position, the G Free Body helps to reduce fatigue and enhance casting comfort.

#### BENEFIT

The closer the reel's centre of gravity is to the rod, the better the combination of rod and reel balance. The reel actually feels lighter, because the weight is closer the hand. This results in a reel with improved casting balance, which requires less casting effort, which will reduce fatigue when fishing over extended periods.

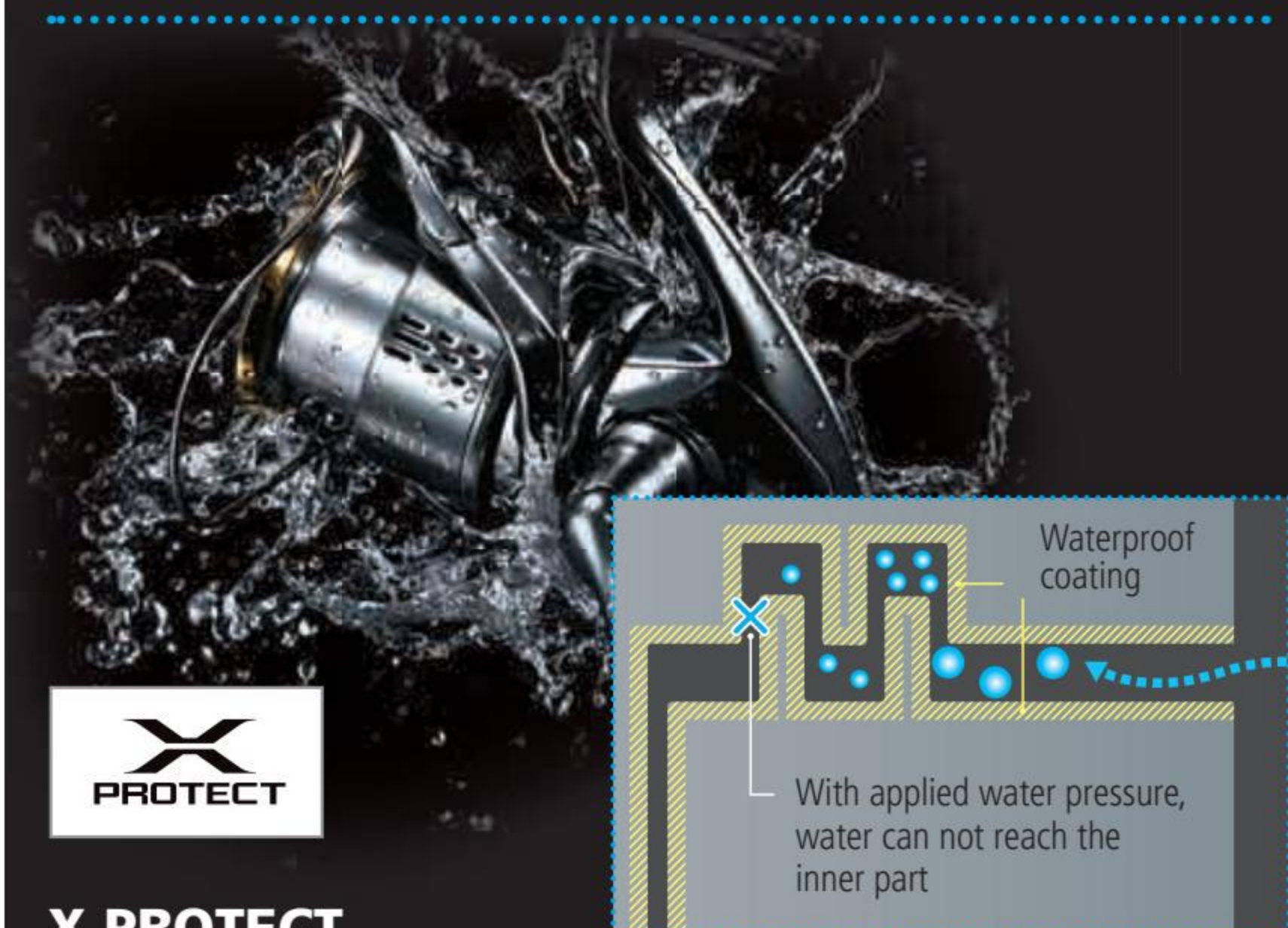

**X-PROTECT**

### X-PROTECT

X-Protect is a water-resistant technology that comes in several forms and is dependent on the reel category and intended usage of each reel. The roller clutch (body area) in large spinning reels works with a "contact style" water resistance. Contact style makes use of a combination of labyrinth construction, rubber gaskets and grease to strongly prevent water from coming into a certain area of the reel. This design makes it possible to achieve up to IPX8 level water resistance for the roller clutch of some larger spinning reels. The roller clutch in smaller reels works with a "non-contact style" water resistance. Non-contact style makes use of a labyrinth structure along with a water repellent material that ensures both light rotation and water resistance performance. Compared to larger reels, smaller reels require sensitivity and a sufficient level of water resistance. The non-contact style protects the reel but does not sacrifice rotation lightness.

#### BENEFIT

X-Protect seals the roller clutch, line roller and drag area, to prevent water intrusion. This advanced protection technology increases the durability of the reel and gives a high level protection in even the toughest conditions. This ensures good performance for a long time, without affecting the smoothness of the reel when rotating.



**CORE PROTECT**

### CORE PROTECT

Core Protect is a SHIMANO technology which is developed to keep water out of the reel, without creating a heavier rotation feeling, in two areas:

1. The Roller Clutch Bearing. This is the most critical area when comes to balancing water resistance without affecting the light and smooth rotation. A surface protection coating causes water to bead preventing water from flowing into the small crevices where it can reach the mechanism of the roller clutch bearing.
2. The Line Roller: A line roller with Core Protect has a one-piece design that provides water resistance and low maintenance. The sealed design does not require oil.

#### BENEFIT

Core Protect prevents water entering the body of the reel. This prevents corrosion and other problems with the gearing or other internal parts of the reel.

## GEARING TECHNOLOGY



**SILENTDRIVE**

The SilentDrive technology encompasses the total redesign of the internal components to reduce microscopic handle play and eliminating noise and any unnatural feeling from the worm shaft drive. The combination of these redesigned components and extremely fine engineering tolerances produces an extremely smooth and silent reeling sensation.

**BENEFIT**  
SilentDrive produces smoother, silent rotation and improved performance. This improves the complete fishing experience of the reel.

## DRAG TECHNOLOGY



**RIGID SUPPORT DRAG**

When hooking a large fish, the smoothness of the initial movement of the drag is the most important to avoid line break. By supporting the spool with the main shaft and two bearing links in the spool, it is possible to suppress the spool's flutter and to provide stable and smooth drag performance.

**BENEFIT**  
Rigid Support Drag eliminates spool movement and wobble, even at light drag settings. The result is an incredibly smooth drag even at extremely light settings.

## BAIL TECHNOLOGY



**ONE PIECE BAIL**

One Piece Bail is a bail arm made from one piece of material, which allows the line to slide very smoothly over it to the line roller. In addition, this one piece construction results in a stronger bail arm, which is much less likely to bend, or even break, under enormous pressure.

**BENEFIT**  
Its seamless and incredibly strong design reduces friction and the chance of tangles when in operation. It also enables the line to be quickly located to the roller when engaging the bail arm after a cast.

## SPOOL TECHNOLOGY



**AR-C SPOOL**

AR-C is a spool-lip design technology exclusive to SHIMANO. Through tens of thousands of casting tests and computer simulations, it has been determined that the AR-C spool lip design provides longer casting distances than a standard spool lip design, while preventing backlashes and wind knots. It also allows the line to flow off the spool in smaller loops during the cast, which means less line slap on the first guide.

**BENEFIT**  
The AR-C spool ensures the line leaves the spool with a minimum of friction and with small loops. This makes longer casting possible with a reduced chance of knots.

## REEL SPECIFICATION EXPLANATION

### PRODUCT CODE

The product code is used by all SHIMANO dealers to identify the model. The number (1000) indicates the reel size.

### REEL SIZE

Reels are available in various sizes: 500, 1000, 2000, 2500, 3000, 4000, 5000, 6000 - and larger. The number indicates the line capacity: a 1000 sized spool contains less line than a 3000 sized spool.

### WEIGHT

The weight indicates the weight of the reel in grams.

### GEAR RATIO

The Gear Ratio of the reel indicates the speed of the reel. This is shown in a number which includes the amount of turns of the rotor (360 degrees) in one full rotation of the handle.

Product Code	Weight (g)	Gear Ratio	Line Capacity (mm/m)	Line Retrieve (cm)	Maximum Drag (kg)	Spare Spool Code
STL1000FJ	170	5.1:1	0.18mm-170m	64	3	RD18877
STL2500FJ	205	5.3:1	0.18mm-290m	78	9	RD18712

### LINE CAPACITY

The spool line capacity indicates how much line can be spooled on the reel spool. This is communicated in length of metres (m) or yards (yds) and line diameter (mm) or line strength (lb).

### LINE RETRIEVE

The 'line retrieve per crank / handle turn' specification explains how much line is retrieved in one full turn of the reel handle. This is measured in centimetres. This indicates the retrieving speed of the reel.

### MAXIMUM DRAG

The maximum drag force is a number in kg / lb, which shows the maximum tension of the drag.

### SPARE SPOOL CODE

The spare spool code for the spool.



## FRONT DRAG REELS

SHIMANO's front drag reel design continually evolves, with new and improved technologies being introduced on a yearly cycle.

The latest STELLA is the ultimate example of this process. With new technologies including INFINITYXROSS, INFINITYLOOP and INFINITYDRIVE, it's our ultimate spinning reel. We call it Infinity Evolution, but to most it's a work of genius!

At the other end of the front drag reel range is the FX, a reel that offers exciting looks, excellent SHIMANO design and engineering and outstanding value for money.

Whichever front drag reel you choose, you can be assured that for quality, value for money and customer experience, SHIMANO leads the way.







10 FRONT DRAG REEL TECHNOLOGY

**CORESOLID**

12	STELLA	<b>NEW</b>
14	TWINPOWER	
15	STRADIC	
16	ULTEGRA	

**SPECIALIST CORESOLID**

18	SOARE BB
19	SEPHIA BB

**MAGNUMLITE**

20	VANQUISH	
22	TWINPOWER XD	
24	SUSTAIN	<b>NEW</b>
25	VANFORD	

**SPECIALIST MAGNUMLITE**

26	EXSENCE
27	CARDIFF CI4+

**SPINNING**

28	NASCI	<b>NEW</b>
30	SAHARA	<b>NEW</b>
31	SEDONA	
	NEXAVE	<b>NEW</b>
32	CATANA	<b>NEW</b>
33	ALIVIO	
	SIENNA	
	FX	



# FRONT DRAG REEL TECHNOLOGY

## METAL ROTOR



### IMPROVED DRAG PERFORMANCE, A SOLID ROTOR THROUGH & THROUGH

Experience the featherweight rigid metal rotor made from Aluminium and Manganese alloys. The high rigidity of the rotor will allow you to fish at ease without worries of distortion. Sturdy yet light, the reeling motion will feel unimaginably smooth.

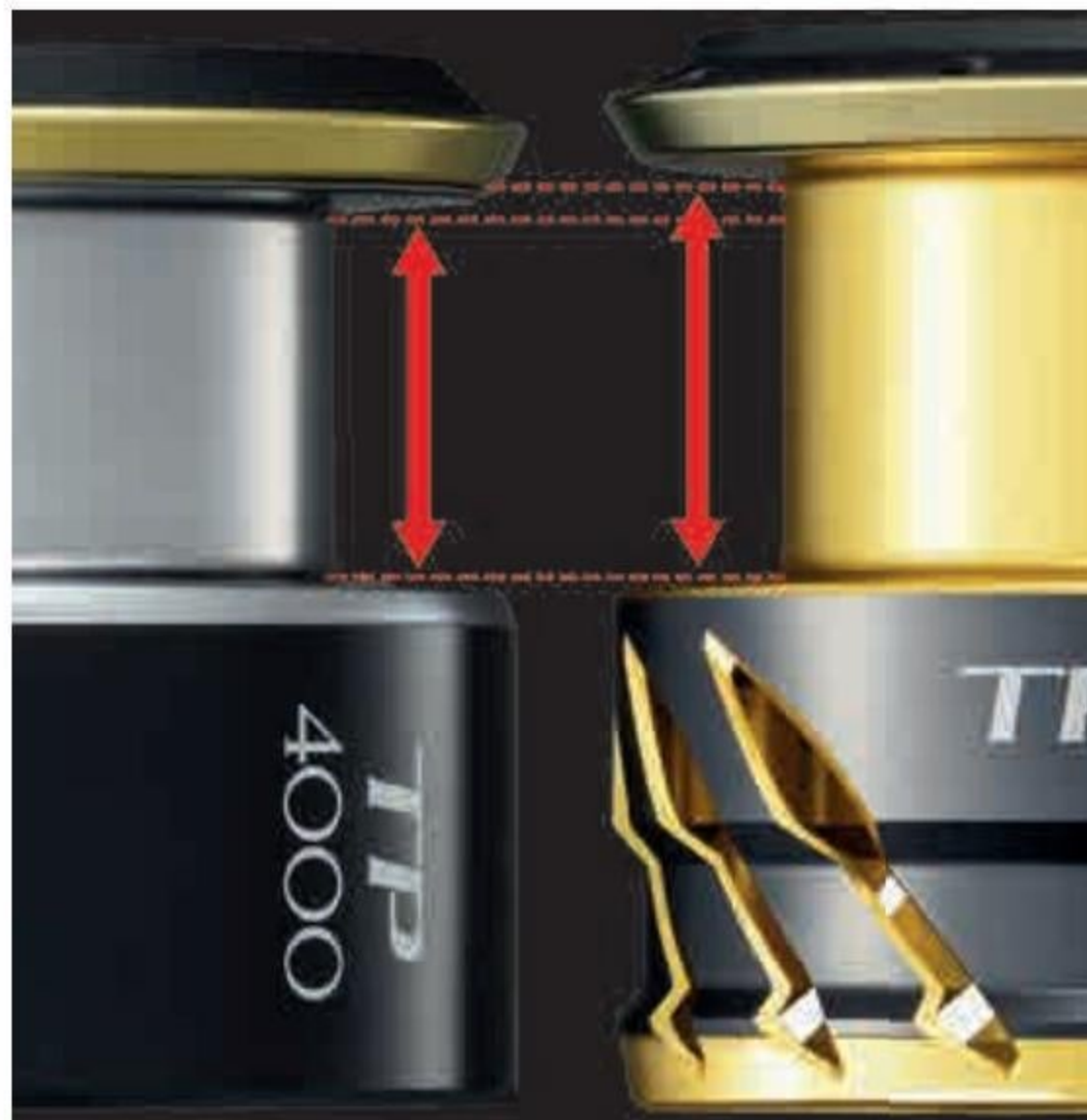

### LONG STROKE SPOOL

#### LONG STROKE SPOOL

The Long Stroke Spool design has a longer stroke, compared to conventional spool designs. This long stroke specification results in longer casting distances.

#### BENEFIT

Long Stroke Spool enables the angler to cast increased distances with the same amount of force.



### MAGNUMLITE ROTOR TECHNOLOGY

The Magnumlite Rotor is an ultra-light improved rotor made out of C4+ material. The profile of the rotor is made asymmetrical and the bail arm mechanism, which is usually situated on the same side as the line roller, has been moved to the opposite side. Both of these changes improve the balance. The rotor rigidity at the line roller side has been improved and reduces the deflection under maximum pressure by up to 30%.

#### BENEFIT

It makes the reel lighter, better balanced and it increases the sensitivity. This contributes to an overall improved experience of the reel with better, lighter and smoother reeling.

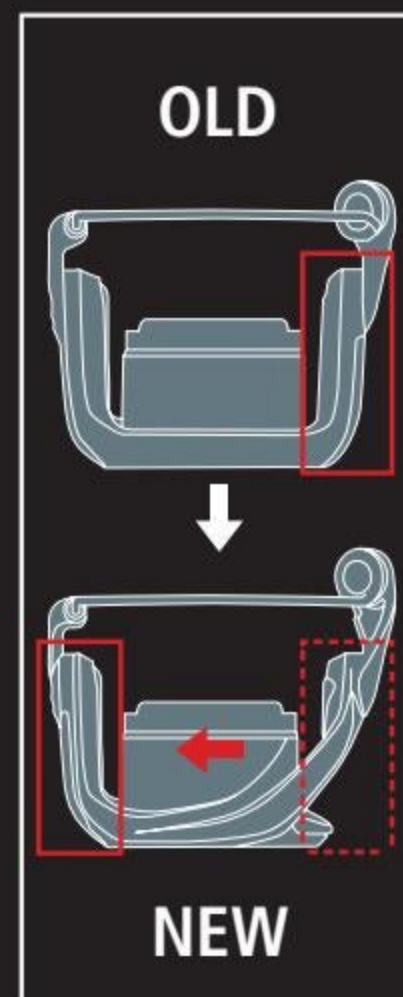

# CORESOLID SERIES

CORESOLID IS THE NAME FOR THE SPINNING REELS THAT HAVE A HIGH ROTOR START-UP INERTIA, RESULTING IN A SILKY SMOOTH ROTATION FEELING.

STELLA

TWIN POWER

STRADIC

ULTEGRA



## SPECIALIST CORESOLID

The SOARE BB is a specialised reel developed for light rock fishing, street fishing and trout area fishing with thin line, while the SEPHIA BB is designed for squid fishing with SHIMANO Egi lures.

Soare BB

Sephia BB



# MAGNUMLITE SERIES

MAGNUMLITE SERIES IS THE NAME FOR SPINNING REELS THAT HAVE A LOW ROTOR START-UP INERTIA, FOR QUICK LURE START-UP AND PRECISE LURE CONTROL.

Vanquish

TWIN POWER XD

SUSTAIN

VANFORD

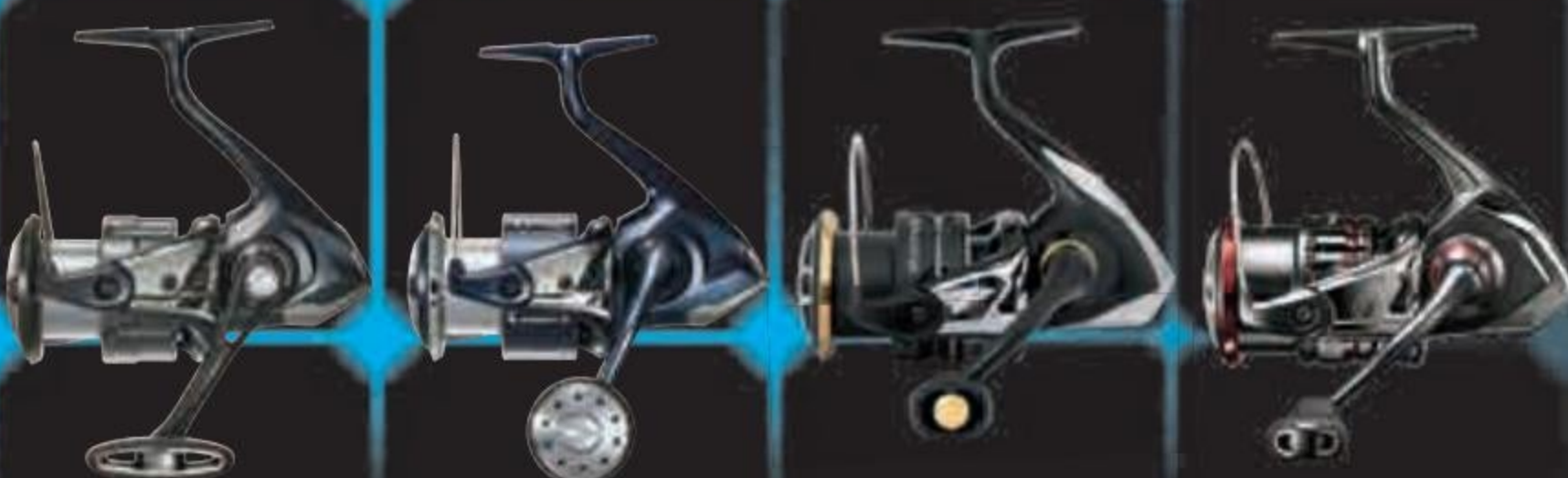

EXSENCE

CARDIFF C14+



## SPECIALIST MGL

The EXSENCE is a specialised reel for saltwater inshore (sea bass) fishing while the CARDIFF C14 is developed to fish for trout with thin monofilament lines, in streams and ponds.

# INFINITY EVOLUTION

NEW

## STELLA

**CORESOLID**

- SHIMANO's most advanced spinning reel with exclusive new technology
- HAGANE Gear enhanced with InfinityXross gear design for increased gear strength and durability
- InfinityLoop ultra slow oscillation for improved casting performance
- InfinityDrive for powerful yet lightweight rotation
- Anti-Twist Fin for trouble free line management
- Duracross Drag for improved drag smoothness, durability and hooking power
- HAGANE Body for increased stiffness and reduced weight
- X-Protect water protection for excellent performance in saltwater environments

**SIZES:** 1000, 2500, 3000, 4000, 5000

**BEARINGS:** 12 + 1

**HANDLE:** Screw in Single Aluminium

**WATERPROOF DRAG:** Yes



	g	⚙️	📏	🔧	🛡️	🏠
STL1000FK	170	5.1:1	0.18mm-170m	64	3	-
STLC2500SFK	175	5.1:1	0.16mm-150m	70	3	RD22185
STL2500FK	210	5.1:1	0.25mm-160m	75	9	RD22028
STL2500SFK	205	5.1:1	0.16mm-150m	75	4	RD22074
STL2500SHGFK	205	5.8:1	0.16mm-150m	86	4	RD22076
STL2500HGFK	210	5.8:1	0.25mm-160m	86	9	RD22083
STLC3000FK	210	5.1:1	0.25mm-210m	75	9	RD22085
STLC3000MHGFK	210	5.8:1	0.25mm-125m	86	9	RD22090
STLC3000XGFK	210	6.4:1	0.25mm-210m	94	9	RD22093
STL4000MFK	260	5.3:1	0.25mm-165m	87	11	-
STL4000XGFK	260	6.2:1	0.30mm-180m	101	11	-
STLC5000XGFK	260	6.2:1	0.35mm-175m	101	11	-



2500HGFK



NEW

### INFINITYXROSS

INFINITYXROSS is an advanced drive gear technology that uses wider gear teeth. The increased surface area distributes pressure more evenly across the full face of the teeth as they meet during rotation. Compared to similar sized gears, INFINITYXROSS increases durability by 100% without affecting smoothness.

#### BENEFIT

INFINITYXROSS delivers more durability, especially when under extreme pressure, resulting in the increased lifespan of the reel. This enables the reel to work to its maximum 'original' performance for longer without degradation.



NEW

### INFINITYLOOP

INFINITYLOOP is an ultra slow line oscillation designed for smaller spinning reels. The spool moves up and down very slowly as the rotor wraps line onto it, allowing the line to spool in an almost parallel configuration. This creates a smooth profile that improves line management when casting and also when playing fish.

#### BENEFIT

INFINITYLOOP oscillation reduces the speed the line travels up and down the spool on the cast. This results in less friction and vibration as line leaves the spool and reduces drag on the lure, which improves casting distance and accuracy. When playing fish, the line is released from the turning spool more smoothly, increasing control.



NEW

### ANTI-TWIST FIN

ANTI-TWIST FIN is an elastic and removable\* fin placed on the rotor next to the line roller. It is designed to create the perfect tension between the line and the spool and improve line management efficiency, especially when using supple, thin diameter braid and mono.

\* Removing the fin is only necessary with lines over 0.47mm or with very large knots.

#### BENEFIT

ANTI-TWIST FIN is especially advantageous for anglers fishing supple, ultra thin braid and mono. If the line between the reel and the lure/lead goes slack when stopping a retrieve, or immediately after casting, the ANTI-TWIST FIN prevents the line from falling away from the line roller and creating additional slack.



NEW

### DURACROSS DRAG

DURACROSS DRAG is an advanced drag washer construction that combines the best characteristics and feel of felt washers, including initial hooking power, with the increased durability of cross-carbon washers.

#### BENEFIT

DURACROSS DRAG is a fantastic combination of feel and durability. It provides enough initial power (spike) to set hooks effectively, with enhanced smoothness and durability for a better fish-playing experience.

# HIGHLY RIGID & DURABLE

## TWIN POWER



- HAGANE Gear and Body plus X-SHIP for efficient, reliable performance
- MicroModule II gearing and SilentDrive technology for ultra smooth, whisper quiet operation
- X-Protect water protection ensuring excellent performance whilst retaining lightweight rotation
- Long Stroke AR-C Spool increases casting distance
- Aero Wrap for excellent line lay
- Suitable for saltwater fishing

**SIZES:** 1000, 2000, 2500, 3000, 4000, 5000

**BEARINGS:** 9 + 1

**HANDLE:** Screw in Aluminium with Septon Knob

**WATERPROOF DRAG:** Yes



4000XG

	9	10	11	12	13	14
TP1000FD	175	5.1:1	0.18mm-170m	64	3	RD20911
TPC2000SFD	180	5.1:1	0.14mm-145m	69	3	RD20933
TP2500FD	210	5.3:1	0.20mm-160m	78	9	RD20573
TP2500SHGFD	210	6.0:1	0.16mm-150m	89	4	RD20601
TPC3000FD	215	5.3:1	0.25mm-210m	78	9	RD20606
5SF29E032 (C3000M HG)	215	6.0:1	0.25mm-210m	89	9	-
TPC3000XGFD	215	6.4:1	0.25mm-210m	94	9	RD20612
TP4000FD	255	5.3:1	0.30mm-180m	87	11	RD20899
TP4000PGFD	260	4.4:1	0.30mm-180m	72	11	RD20906
TP4000XGFD	260	6.2:1	0.30mm-180m	101	11	RD20907
TP4000MHGFD	255	5.8:1	0.30mm-120m	95	11	RD20904
TPC5000XGFD	260	6.2:1	0.35mm-175m	101	11	RD20908



# CONTINUOUS EVOLUTION

## STRADIC



- HAGANE Gear, MicroModule and SilentDrive combined, deliver exquisitely smooth, quiet, lightweight rotation
- X-SHIP for increased cranking power
- X-Protect waterproof protection
- Long Stroke AR-C spool increases casting distance
- Aero Wrap for excellent line lay
- Waterproof drag
- Carbon Cross Washer

**SIZES:** 1000, 2500, 3000, 4000, 5000

**BEARINGS:** 6 + 1

**HANDLE:** Screw in Single Aluminium

**WATERPROOF DRAG:** Yes



	g	Ratio	Line	Length	Spool	Drag
ST1000FL	185	5.1:1	0.18mm-170m	64	3	RD20130
ST1000HGFL	185	6.0:1	0.18mm-170m	75	3	RD20177
ST2500FL	220	5.3:1	0.20mm-240m	78	9	RD19768
ST2500HGFL	225	6.0:1	0.20mm-240m	89	9	RD20000
STC3000FL	225	5.3:1	0.25mm-210m	78	9	RD20031
STC3000HGFL	225	6.0:1	0.25mm-210m	89	9	RD20032
STC3000XGFL	225	6.4:1	0.25mm-210m	94	9	RD20039
ST4000FL	280	5.3:1	0.30mm-180m	87	11	RD20241
ST4000MHGFL	280	5.8:1	0.30mm-120m	95	11	RD20299
ST4000XGFL	280	6.2:1	0.30mm-180m	101	11	RD20309
STC5000XGFL	295	6.2:1	0.35mm-175m	101	11	RD20319



C3000XG



# EXCELLENT CASTING

## ULTEGRA



- Mid-priced Coresolid series spinning reel with many of SHIMANO's latest technology and design features
- HAGANE Gear, MicroModule II, X-SHIP and SilentDrive for efficient winding smoothness and power under pressure
- X-Protect technology prevents water ingress into the line roller and roller clutch for smoother, trouble free performance
- Long Stroke Spool and Aero Wrap for excellent casting performance
- Wide range of sizes from 1000 to 5000 cover almost all freshwater lure fishing requirements

**SIZES:** 1000, 2000, 2500, 3000, 4000, 5000

**BEARINGS:** 5 + 1

**HANDLE:** Screw in Single Aluminium

**WATERPROOF DRAG:** Yes

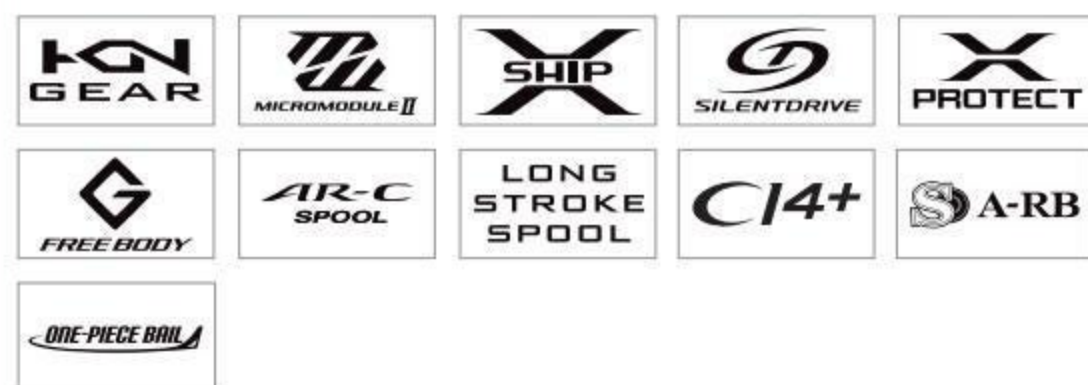

	g	Ratio	Line Capacity	Retrieval	Spool Turns	Part No.
ULT1000FC	180	5.1:1	0.18mm-170m	64	3	RD21576
ULTC2000SFC	185	5.1:1	0.14mm-145m	69	3	RD21583
51SF52D024A (C2000S HG)	185	6.1:1	0.14mm-145m	82	3	-
ULTC2000HGFC	185	6.1:1	0.14mm-145m	82	3	RD21584
ULT2500FC	225	5.3:1	0.18mm-290m	78	9	RD21400
ULT2500HGFC	225	6.0:1	0.18mm-290m	89	9	RD21429
51SF52E027A (2500S HG)	220	6.0:1	0.16mm-150m	89	4	-
ULTC3000FC	225	5.3:1	0.25mm-210m	78	9	RD21432
ULTC3000HGFC	225	6.0:1	0.25mm-210m	89	9	RD21434
ULTC3000XGFC	225	6.4:1	0.25mm-210m	94	9	RD21436
ULT4000FC	270	5.3:1	0.25mm-260m	87	11	RD21553
ULT4000XGFC	270	6.2:1	0.25mm-260m	101	11	RD21567
ULTC5000XGFC	285	6.2:1	0.35mm-175m	101	11	RD21570



C3000





# FRONT DRAG REELS



C2000SSPG

## Soare BB



- Designed for Trout Area, Street Fishing, light rock fishing and other applications where ultra thin line is used
- HAGANE Gear and X-SHIP for efficient performance
- Low speed gear ratio of 4.3:1 for precise control and powerful winding
- Coreprotect for protection against water intrusion to the body, drag and line roller
- Shallow spool (0.12mm - 155m) for ultra fine braided lines
- Aero Wrap for excellent line lay
- G Free body for improved balance
- AR-C cold forged aluminium spool

**SIZES:** 2000

**BEARINGS:** 5 + 1

**HANDLE:** Screw in Single Aluminium

**WATERPROOF DRAG:** Yes



51SF23B019A (C2000S PG) | 200 4.3:1 0.12mm-155m 57 3 60209X8190P

# SPECIALIST CORESOLID

The specialised CORESOLID line-up covers a selection of specialised reels from the Japanese range. These reels have been developed and engineered specifically for certain fishing styles. The SOARE BB is a specialised reel for light rock fishing, street fishing and trout area fishing with thin line, while the SEPHIA BB is designed for squid fishing with SHIMANO Egi lures.

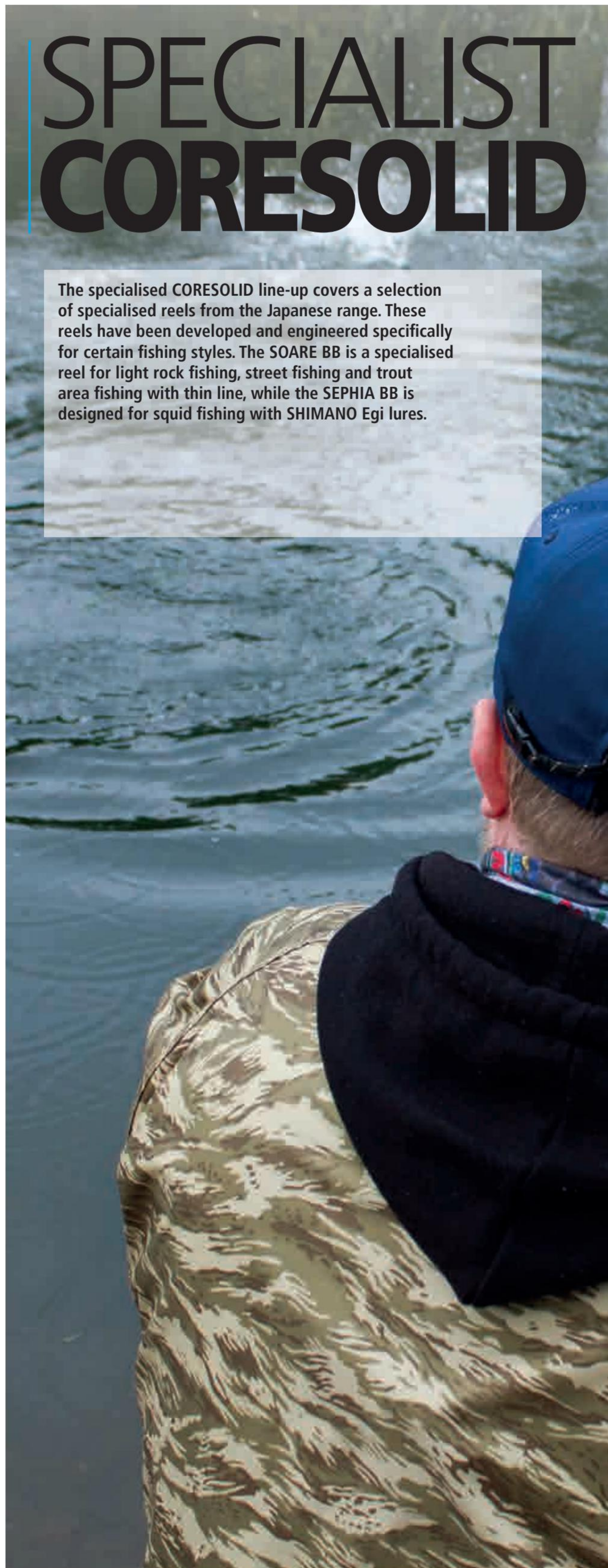



C3000S

## Sephia BB

**CORESOLID**

- Designed for squid fishing using Egi lures
- HAGANE Gear and X-SHIP for efficient performance
- Coreprotect for protection against water intrusion to the body, drag and line roller
- Special EVA handle designed for egging
- Aero Wrap for excellent line lay
- G Free body for improved balance
- AR-C cold forged aluminium spool
- Rapid Fire drag (9kg max) for quick adjustment and control
- One piece bail for the smooth line guidance

**SIZES:** 3000

**BEARINGS:** 5 + 1

**HANDLE:** Screw in Single Aluminium



51SF26E030A (C3000S)



235 5.0:1 0.16mm-150m 73 9 60209Y1300P

# TRUE LIGHTNESS

## Vanquish



- The lightest reel (like-for-like size) ever made by SHIMANO, perfect for lightweight and powerful fishing in fresh and saltwater
- MicroModule II gear for ultra smooth winding
- HAGANE Gear and X-SHIP for efficient performance
- SilentDrive, re-engineered components reduce microscopic movement in the handle resulting in quieter operation
- X-Protect technology gives high level water protection, ensuring excellent performance whilst retaining lightweight rotation
- MGL rotor enhances lightweight rotation
- Long Stroke Spool increases casting distance
- Aero Wrap for excellent line lay

**SIZES:** 1000, 2000, 2500, 3000, 4000, 5000

**BEARINGS:** 11 + 1

**HANDLE:** Screw in Ci4+ (1000-4000 models)  
Screw in Single Aluminium (5000 model)

**WATERPROOF DRAG:** Yes



55F28B013 (1000SSS PG)	145	4.6:1	0.18mm-80m	58	3	-	<b>NEW</b>
VQC2000SFB	145	5.1:1	0.18mm-80m	69	3	RD19264	
VQC2500SHGFB	155	6.0:1	0.16mm-150m	81	3	RD19287	
VQ2500SFB	165	5.3:1	0.16mm-150m	78	4	RD19081	
VQ2500SHGFB	165	6.0:1	0.16mm-150m	89	4	RD19145	
VQC3000FB	170	5.3:1	0.25mm-210m	78	9	RD19152	
VQC3000MHGFB	170	6.0:1	0.25mm-125m	89	9	RD19155	
VQ4000MHGFB	200	5.8:1	0.30mm-120m	95	11	RD19391	
VQ4000XGFB	200	6.2:1	0.30mm-180m	101	11	RD19348	
VQC5000XGFB	220	6.2:1	0.35mm-175m	101	11	RD19401	



C3000XG



# SENSITIVE POWER

## TWIN POWER XD



- Increased strength HAGANE Gear to overcome the most extreme pressure
- MicroModule II plus SilentDrive for super smooth reeling
- HAGANE Body for assured protection and rigidity with advanced G Free design
- Lightweight MGL Rotor, made of Ci4+ material, for sensitive, precise lure control
- X-Protect to prevent water intrusion to the line roller and roller clutch
- X-SHIP for increased cranking power and smooth rotation under heavy load
- Long Stroke Spool and Aero Wrap for superior casting performance
- AR-C lightweight cold forged aluminium spool with TI coating

**SIZES:** 3000, 4000, 5000

**BEARINGS:** 10 + 1

**HANDLE:** Screw in Single Aluminium

**WATERPROOF DRAG:** Yes



	9	10	11	12	13	14
TPXDC3000HGFA	200	6.0:1	0.25mm-210m	89	9	RD21442
TPXDC3000XGFA	200	6.4:1	0.25mm-210m	94	9	RD21452
TPXD4000PGFA	245	4.4:1	0.25mm-260m	72	11	RD21468
TPXD4000HGFA	245	5.8:1	0.25mm-260m	95	11	RD21454
TPXD4000XGFA	245	6.2:1	0.25mm-260m	101	11	RD21464
TPXDC5000XGFA	245	6.2:1	0.30mm-240m	101	11	RD21466



C5000XG



# STRONG & SENSITIVE

NEW

## SUSTAIN



- Lightweight, versatile spinning reel for freshwater and inshore saltwater fishing
- Light rotation start-up and sensitive winding due to Ci4+ MGL Rotor
- SilentDrive technology delivers smooth and whisper quiet operation
- High strength, lightweight aluminium HAGANE Body
- X-Protect water and dirt protection on the line roller and body
- Long Stroke Spool for improved casting distance

**SIZES:** 2500, 3000, 4000, 5000

**BEARINGS:** 8 + 1

**HANDLE:** Screw in Single Aluminium

**WATERPROOF DRAG:** Yes



SA2500FJ	210	5.3:1	0.18mm-290m	78	9	RD21783
SA2500HGFJ	210	6.0:1	0.18mm-290m	89	9	RD21794
SAC3000FJ	210	5.3:1	0.25mm-210m	78	9	RD21798
SAC3000HGFJ	210	6.0:1	0.25mm-210m	89	9	RD21801
SAC3000XGFJ	210	6.4:1	0.25mm-210m	94	9	RD21803
SA4000FJ	260	5.3:1	0.25mm-260m	87	11	RD21991
SA4000HGFJ	260	5.8:1	0.25mm-260m	95	11	RD22000
SA4000XGFJ	275	6.2:1	0.25mm-260m	101	11	RD22002
SAC5000XGFJ	270	6.2:1	0.30mm-240m	101	11	RD22006



2500HGFJ





# SUPER FAST

## VANFORD



- Vanford is the 'entry-level' Magnumlite Series reel designed for sensitive and finesse techniques
- Features Ci4+ Body and Rotor for remarkable lightweight performance
- MGL Rotor and Micromodule II gear for ultra sensitive, lightweight rotation suitable for precise lure control
- MicroModule II Gear and SilentDrive for ultra smooth, ultra quiet operation, even under pressure
- HAGANE Gear and X-SHIP for efficient, powerful performance

**SIZES:** 500, 1000, 2000, 2500, 3000, 4000, 5000

**BEARINGS:** 6 + 1 (500 model) 7 + 1

**HANDLE:** Screw in Single Aluminium

**WATERPROOF DRAG:** Yes



	g	Ratio	Line	Length	Retr	Spool
VF500F	140	5.6:1	0.20mm-110m	69	2.5	RD21149
VF1000F	150	5.1:1	0.20mm-140m	64	3	RD21127
VFC2000SF	150	5.1:1	0.14mm-145m	69	3	RD21129
VFC2000SHGF	150	6.1:1	0.14mm-145m	82	3	RD21142
VF2500F	180	5.3:1	0.25mm-160m	78	9	RD20980
51SF36E026A (2500S)	175	5.3:1	0.18mm-120m	78	4	-
VF2500SHGF	175	6.0:1	0.16mm-150m	89	4	RD21026
VF2500HGF	180	6.0:1	0.25mm-160m	89	9	RD21021
VFC3000F	180	5.3:1	0.25mm-210m	78	9	RD21036
VFC3000HGF	180	6.0:1	0.25mm-210m	89	9	RD21039
VF4000F	215	5.3:1	0.30mm-180m	87	11	RD21229
VF4000MHGF	215	5.8:1	0.25mm-165m	95	11	RD21258
VF4000XGF	215	6.2:1	0.30mm-180m	101	11	RD21262
VFC5000XGF	220	6.2:1	0.35mm-175m	101	11	RD21267



# FRONT DRAG REELS



C3000M

## EXSENCE



- Lightweight, immensely strong reel featuring the latest Magnumlite technology
- HAGANE Gear and Body plus X-SHIP for efficient, reliable performance
- MicroModule II gearing and SilentDrive technology for ultra smooth, whisper quiet operation
- X-Protect water protection ensuring excellent performance in saltwater environments
- MGL rotor enhances super lightweight start-up rotation for enhanced lure control
- Long Stroke AR-C Spool increases casting distance
- Aero Wrap for excellent line lay
- Suitable for inshore saltwater fishing and fine diameter braid in freshwater

**SIZES:** 3000, 4000

**BEARINGS:** 11 + 1

**HANDLE:** Screw in Single Aluminium

**WATERPROOF DRAG:** Yes



EXSC3000MHGA	180	6.0:1	0.25mm-125m	88	9	RD21662
EXS4000MXGA	220	6.2:1	0.25mm-165m	99	11	RD21663

# SPECIALIST MGL

The specialised MAGNUMLITE line-up covers a selection of specialised reels from the Japanese range. These reels have been developed and engineered specifically for certain fishing styles. The EXSENCE is a specialised reel for salt water inshore (sea bass) fishing while the CARDIFF Ci4 is developed to fish for trout with thin monofilament lines, in streams and ponds.





1000S

## CARDIFF Ci4+



- Designed for Trout Area fishing (1000 size) and native trout applications (3000 size)
- HAGANE Gear and X-SHIP for efficient performance
- Ultra lightweight Ci4+ construction
- MGL rotor enhances lightweight rotation
- Coreprotect for protection against water intrusion to the body, drag and line roller (1000 size) X-Protect (3000 size)

**SIZES:** 1000, 3000

**BEARINGS:** 9 +1

**HANDLE:** Screw in Single Aluminium

**WATERPROOF DRAG:** Yes



51SF22B010A (1000S)	170	5.0:1	0.14mm-115m	66	3	60209X7100P
51SF22E032A (C3000M HG)	200	6.0:1	0.25mm-125m	88	9	60209X7320P

# BORN TO FISH

NEW

## NASCI

- Mid-priced series spinning reel with many of SHIMANO's latest technology and design features
- Modern understated monochromatic appearance
- HAGANE Gear for ultra smooth winding and X-SHIP for increased torque and efficiency
- Coreprotect technology prevents water ingress into the line roller and roller clutch
- G Free body made from lightweight Ci4+ for reduced weight and improved balance
- Wide range of sizes from 500 to 5000 **perfectly complementing the NASCI Spinning rod range on page 144/145**

**SIZES:** 500, 1000, 2000, 2500, 3000, 4000, 5000

**BEARINGS:** 4 + 1 (500) 5 + 1

**HANDLE:** Screw in Single Aluminium



not available on 500 model



	9	9	9	9	9	9
NAS500FC	170	5.6:1	0.20mm-110m	69	3	RD21951
NAS1000FC	205	5.0:1	0.18mm-170m	66	3	RD21961
NASC2000SFC	210	5.0:1	0.14mm-145m	66	3	RD21975
NASC2000SHGFC	210	6.0:1	0.14mm-145m	79	3	RD21977
NAS2500FC	240	5.0:1	0.18mm-290m	73	9	RD21806
NAS2500SHGFC	240	6.2:1	0.16mm-150m	91	4	RD21824
NAS2500HGFC	240	6.2:1	0.18mm-290m	91	9	RD21827
NASC3000FC	240	5.0:1	0.25mm-210m	73	9	RD21829
NASC3000HGFC	240	6.2:1	0.25mm-210m	91	9	RD21832
NAS4000FC	285	4.7:1	0.25mm-260m	75	11	RD21848
NAS4000XGFC	285	6.2:1	0.25mm-260m	99	11	RD21862
NASC5000XGFC	305	6.2:1	0.30mm-240m	105	11	RD21865



2500

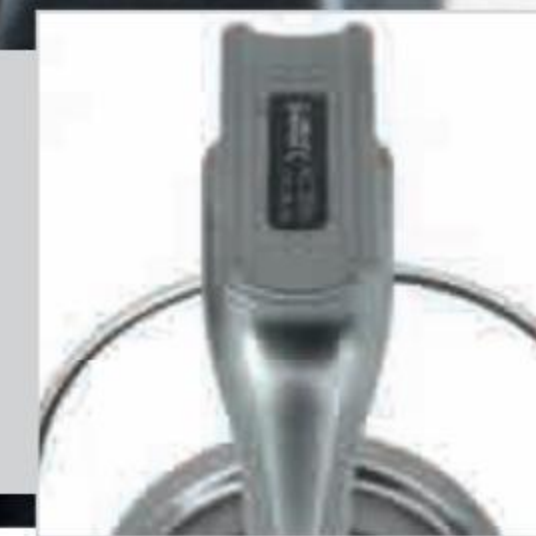

# DURABLE PERFORMANCE

NEW

## SAHARA

- HAGANE Gear and X-SHIP to withstand the toughest conditions
- SilentDrive for ultra-smooth rotation and enhanced fishing experience
- Lightweight XT-7 G Free body for optimum balance and reduced fatigue
- Aluminium AR-C spool design for smooth accurate casting
- Varispeed II line lay for improved line management
- Anti-reverse facility for backwinding

**SIZES:** 500, 1000, 2000, 2500, 3000, 4000, 5000

**BEARINGS:** 3+1 (500 model) 4 + 1

**HANDLE:** Screw in Single Aluminium

*not available on 500 model*



	g	Ratio	Line	Ret	Bearings	Model
SH500FJ	170	5.6:1	0.20mm-110m	69	3	RD22123
SH1000FJ	205	5.0:1	0.18mm-170m	66	3	RD22132
SHC2000FJ	210	5.0:1	0.14mm-145m	66	3	RD22140
SHC2000SHGFJ	210	6.0:1	0.14mm-145m	79	3	RD22142
SH2500FJ	240	5.0:1	0.25mm-160m	73	9	RD22104
SH2500SHGFJ	240	6.2:1	0.16mm-150m	91	4	RD22113
SHC3000FJ	240	5.0:1	0.25mm-210m	73	9	RD22115
SHC3000HGFJ	240	6.2:1	0.25mm-210m	91	9	RD22120
SHC3000DHFJ	265	5.0:1	0.25mm-210m	73	9	RD22115
SH4000FJ	280	4.7:1	0.30mm-180m	75	11	-
SH4000XGFJ	280	6.2:1	0.30mm-180m	99	11	-
SHC5000XGFJ	305	6.2:1	0.35mm-175m	105	11	-



C3000





2500

## SEDONA

- SHIMANO's most affordable HAGANE Gear reel
- Varispeed II line lay for improved casting
- Cold forged AR-C spool

**SIZES:** 500, 1000, 2000, 2500, 3000, 4000, 5000, 6000, 8000

**BEARINGS:** 3 + 1

**HANDLE:** Single Aluminium



	g	Ratio	Line	Length	Ret	RD	
SE500FI	185	5.6:1	0.20mm	110m	69	2.5	RD19054
SE1000FI	215	5.0:1	0.18mm	170m	66	3	RD18122
SEC2000SFI	215	5.0:1	0.14mm	145m	66	3	RD18128
SEC2000HGFI	215	6.0:1	0.14mm	145m	79	3	RD18128
SE2500FI	245	5.0:1	0.18mm	290m	73	4	RD18132
SE2500HGFI	245	6.2:1	0.18mm	290m	91	4	RD18132
SE2500SFI	245	5.0:1	0.16mm	150m	73	4	RD18138
SEC3000FI	250	5.0:1	0.25mm	210m	73	9	RD18141
SEC3000HGFI	250	6.2:1	0.25mm	210m	91	9	RD18141
SEC3000DHFI	275	5.0:1	0.25mm	210m	73	9	RD18141
SE4000FI	295	4.7:1	0.25mm	260m	75	11	RD18147
SE4000XGFI	295	6.2:1	0.25mm	260m	99	11	RD18147
SEC5000XGFI	300	6.2:1	0.30mm	240m	105	11	RD18154
SE6000FI	425	4.6:1	0.33mm	240m	83	10	RD18331
SE8000FI	615	4.9:1	0.37mm	275m	94	11	RD18346



2500

NEW

## NEXAVE

- Low-priced spinning reel with shielded stainless ball bearings
- AR-C spool design for smoother and more accurate casting
- G-Free Body for improved balance
- Wide range of sizes from 1000 to 5000 to cover almost all freshwater fishing requirements

**SIZES:** 1000, 2500, 3000, 4000, 5000

**BEARINGS:** 3 + 1

**HANDLE:** Zinc Diecast



	g	Ratio	Line	Length	Ret	RD	
NEX1000FI	220	5.0:1	0.18mm	170m	66	3	RD21981
NEX2500FI	250	5.0:1	0.18mm	290m	73	4	RD21766
NEX2500SFI	265	5.0:1	0.16mm	150m	73	4	RD21776
NEX2500HGFI	250	6.0:1	0.18mm	290m	91	4	RD21777
NEXC3000FI	255	5.0:1	0.25mm	210m	73	9	RD21780
NEXC3000HGFI	255	6.2:1	0.25mm	210m	91	9	RD21782
NEX4000FI	305	5.2:1	0.25mm	260m	83	11	RD21834
NEX4000HGFI	305	5.8:1	0.25mm	260m	93	11	RD21843
NEXC5000HGFI	305	5.8:1	0.30mm	240m	98	11	RD21846

# IMPROVED BALANCE

NEW

## CATANA

- Affordably-priced spinning reel with modern understated graphics
- Aluminium AR-C spool design for smooth accurate casting
- Lightweight XT-7 G Free Body for improved balance
- 3 high quality SHIMANO Stainless Steel Ball Bearings + Roller Bearing
- Varispeed II line lay for improved line management
- A range of sizes from 1000 to 4000 **perfectly complementing the CATANA Spinning rod range on page 148/149**

**SIZES:** 1000, 2500, 3000, 4000

**BEARINGS:** 3+1

**HANDLE:** Zinc Diecast

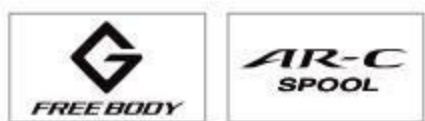

CAT1000FE	230	5.0:1	0.18mm-170m	66	3	RD22158
CAT2500FE	260	5.0:1	0.25mm-160m	73	4	RD22173
CAT2500HGFE	260	6.2:1	0.25mm-160m	91	4	RD22179
CATC3000FE	260	5.0:1	0.25mm-160m	73	8.5	RD22180
CATC3000HGFE	260	6.2:1	0.25mm-160m	91	8.5	RD22182
CAT4000FE	320	5.2:1	0.30mm-180m	83	8.5	RD22166
CAT4000HGFE	320	5.8:1	0.30mm-180m	93	8.5	RD22171







6000FA

# ALIVIO

- A stunning front drag reel offering excellent value for specimen and carp anglers
- Varispeed line lay, resulting in longer and more accurate casts
- 4.9:1 gear ratio provides good winding power for big fish
- Available in powerful 6000 and 10000 sizes for specimen fishing or light surf casting

**BEARINGS:** 1 + 1

ALV6000FA	590	4.9:1	0.35mm-240m	90	8	RD10715
ALV10000FA	580	4.9:1	0.35mm-380m	94	8	RD10725



2500

# SIENNA

- The ideal choice for an angler who is just starting fishing or for someone on a tight budget
- A reliable reel with a strong XT-7 body
- Smooth SHIMANO gearing
- Aluminium AR-C spool

**BEARINGS:** 3 + 1

SN500FG	195	5.6:1	0.20mm-110m	69	2	RD20413
SN1000FG	225	5.0:1	0.18mm-170m	66	3	RD20423
SN2000FG	250	5.0:1	0.18mm-215m	71	4	RD20208
SN2500FG	250	5.0:1	0.25mm-160m	71	4	RD20191
SN2500HGFG	250	6.2:1	0.25mm-160m	88	4	RD20209
SNC3000FG	250	5.0:1	0.25mm-210m	71	8.5	RD20212
SN4000FG	320	5.2:1	0.30mm-180m	82	8.5	RD20342



2500HG

# FX

- An all round spinning reel which replaces the previous FX, AX and HYPERLOOP reels
- The ideal choice for an angler who is just starting fishing or for someone on a tight budget
- A reliable reel with a strong XT-7 body, smooth SHIMANO gearing and aluminium AR-C spool

**BEARINGS:** 2 + 1

FX1000FC	225	5.0:1	0.18mm-170m	66	3	RD20352
FX2000FC	250	5.0:1	0.18mm-215m	71	4	RD20234
FX2500FC	250	5.0:1	0.25mm-160m	71	4	RD20215
FX2500HGFC	250	6.2:1	0.25mm-160m	88	4	RD20235
FXC3000FC	250	5.0:1	0.25mm-210m	71	8.5	RD20236
FX4000FC	320	5.2:1	0.30mm-180m	82	8.5	RD20328





## REAR DRAG REELS

For all-round fishing (float, feeder, spinning) SHIMANO rear drag reels offer great versatility.

The position of the rear drag adjustment at the rear of the reel makes it very easy to use and many models also feature SHIMANO Fightin' Drag for even easier adjustment whilst fighting a fish.





36	STRADIC CI4+ RA
	STRADIC GTM-RC
	SUPER GT RD
37	SAHARA R
	CATANA RC
	SIENNA RE

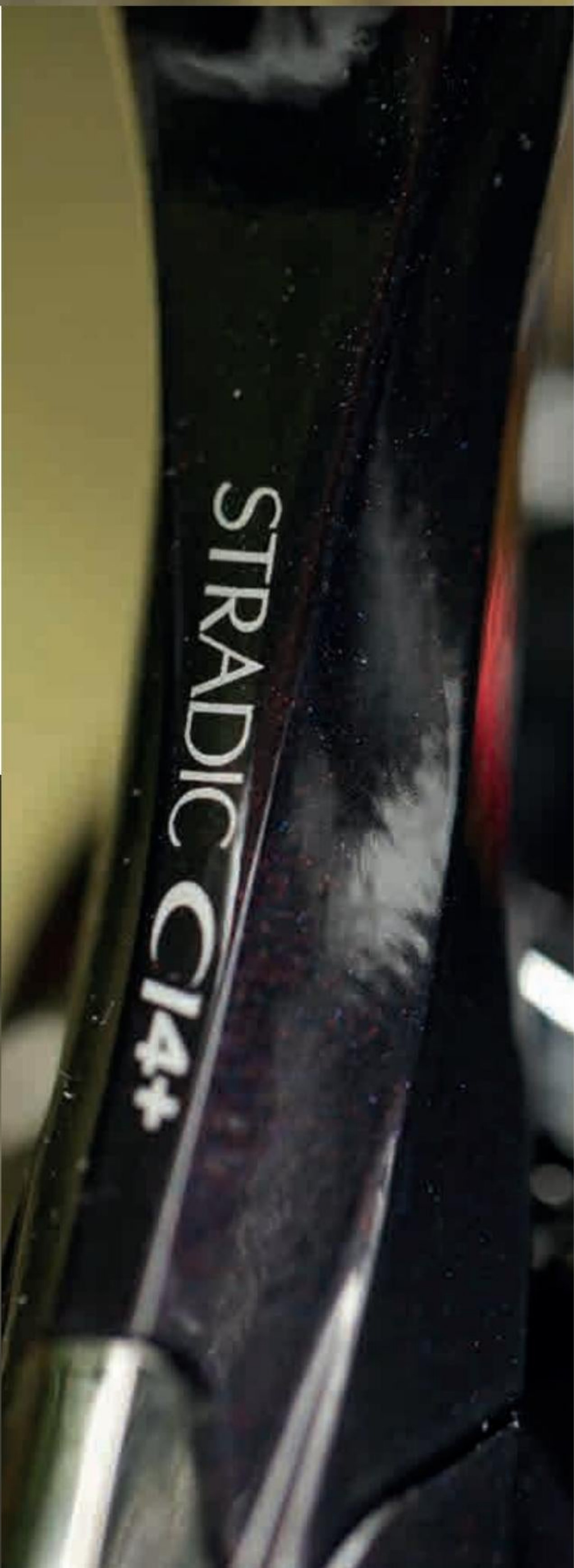

# REAR DRAG REELS



## STRADIC Ci4+

- Ultra lightweight Ci4+ body material delivers outstanding weight reduction
- SHIMANO's famous quick adjustment Fightin' Drag allows easy drag adjustments whilst playing fish
- 2500 size has high gear 6.0:1 retrieve
- Aero Wrap for improved line lay
- Push button, quick release spool
- Cold forged aluminium spare spool

**BEARINGS:** 5 + 1

**SPOOL REDUCER 2500:** 0.25mm-90m (x2) RD16808

**SPOOL REDUCER 4000:** 0.20mm-110m (x2) RD17135

	g	Ratio	Line	Retrieves	Spool	RD
STCi42500RA	255	6.0:1	0.20mm-240m	98	2.5	RD17094
STCi44000RA	310	5.2:1	0.25mm-260m	93	3	RD17114



2500



## STRADIC GTM

- A classic SHIMANO reel that has established an enviable reputation for its looks, quality and performance
- GTM reels have a super-fast retrieve ratio of 6.0:1 or 5.8:1
- SHIMANO's famous quick adjustment Fightin' Drag allows increase or decrease of the drag instantly
- Pearl-white XT-7 body, rotor and double handle complimented by an AR-C Cold Forged aluminium spool
- Push button, quick release spool

**BEARINGS:** 4 + 1

	g	Ratio	Line	Retrieves	Spool	RD
STR2500GTMRC	315	6.0:1	0.20mm-240m	88	2.5	RD13148
STR3000SGTMRC	345	6.0:1	0.25mm-140m	92	2.5	RD13165
STR4000SGTMRC	390	5.8:1	0.30mm-100m	95	3	RD13134



4000



## SUPER GT

- SHIMANO's famous quick adjustment Fightin' Drag allows quick adjustments of the drag system
- Single machined aluminium handle for increased winding power
- Push button quick release AR-C spool for improved casting
- Aero Wrap oscillation for excellent line lay
- Power Roller reduces line twist

**BEARINGS:** 3 + 1

**SPOOL REDUCER 2500:** 0.25mm-90m (x2) RD16808

**SPOOL REDUCER 4000:** 0.20mm-110m (x2) RD17135

	g	Ratio	Line	Retrieves	Spool	RD
SUP2500GTRD	290	5.0:1	0.20mm-240m	82	2.5	RD17300
SUP4000GTRD	355	4.8:1	0.25mm-260m	86	3	RD17312



# SAHARA

- A mid-level rear drag model with eye-catching stunning metallic platinum and gold finish
- Excellent multi-disk rear drag system and Fightin' Drag
- Varispeed line lay prevents fine mono and braid bedding in under pressure

**BEARINGS: 3 + 1**

SH1000R	255	5.2:1	0.20mm-140m	69	2	RD18273
SH2500R	275	5.2:1	0.25mm-160m	76	2	RD18291
SH3000SR	280	5.2:1	0.25mm-140m	76	2	RD18299
SH4000R	335	5.1:1	0.30mm-180m	82	3	RD18307
SH2500DHR	320	5.2:1	0.25mm-160m	76	2	RD18291
SH3000SSDHHGR	355	6.2:1	0.18mm-130m	91	2	RD18302
SH4000DHR	375	5.1:1	0.30mm-180m	82	3	RD18307

2500R

2500 DHR



# CATANA

- The CATANA RC perfectly fits the needs of anglers looking for a low-budget, but smoothly running rear drag reel
- Designed for freshwater fishing, mainly aiming at Bolognese, tele trout and young anglers spin fishing for perch, pike or zander
- The smoothly running drag has enough power to fish on commercials and fight carp and other hard-fighting fish

**BEARINGS: 1 + 1**

CAT1000RC	270	5.2:1	0.18mm-170m	69	2	RD18627
CAT2500RC	300	5.2:1	0.20mm-240m	76	2	RD18635
CAT3000SRC	300	5.2:1	0.18mm-240m	76	2	RD18639
CAT4000RC	370	5.1:1	0.30mm-180m	82	3	RD18641



# SIENNA

- Exceptional value for money offering smooth, assured performance across a wide range of fishing styles
- Easily adjustable rear drag for confident fish-playing performance
- Aluminium AR-C spool for improved casting performance
- New design rotor offering good balance when retrieving at high speed
- Higher grade composite material for lightness and strength

**BEARINGS: 1 + 1**

SN1000RE	270	5.2:1	0.18mm-170m	69	2	RD19009
SN2500RE	300	5.2:1	0.20mm-240m	76	2	RD19016
SN4000RE	365	5.1:1	0.25mm-260m	82	3	RD19019



2500



## BIG PIT REELS

On larger waters, where casting distance is essential, using the correct reel is as important as using the correct rod. SHIMANO's Big Pit/Surfcasting reels, with Slow Oscillation, Super Slow Oscillation and the Parallel Body design add noticeable casting distance compared to other reels of the same size.

Slow line oscillation wraps the line onto the spool in a more organised way, with the coils of line laying closer to the next one on the spool. On Parallel Body design reels the body of the reel is parallel to the blank of the rod, rather than the reel tilting slightly towards the rod.

The combination of Slow or Super Slow Oscillation and Parallel Body offers the ultimate in distance casting performance.





40	BIG PIT TECHNOLOGY	
42	AERO TECHNIUM MGS	<b>NEW</b>
44	FLIEGEN SD	
45	POWER AERO XTB	
	POWER AERO XSB	
46	BULLS EYE	
	SURF LEADER CI4+ SD	
47	ULTEGRA CI4+ XTC	
	ULTEGRA CI4+ XSC	
48	ULTEGRA XTD / SPOD	
49	ULTEGRA XSD / COMPETITION	
50	SPEEDMASTER XTC / XSC	
51	AERLEX XTB	
	AERLEX XSB	
	BEASTMASTER XB	



# LONG RANGE CASTING TECHNOLOGY

OFFERING THE ULTIMATE IN DISTANCE  
CASTING PERFORMANCE



## PARALLEL BODY

SHIMANO's Parallel Body technology ensures the rod and reel alignment is perfectly parallel. The axle and spool are parallel to the rod, minimising the amount of line slapping onto the blank between the spool and the first guide during the cast.

## BENEFIT

Parallel Body increases the overall casting performance of a reel. It makes more precise and longer casting possible, and reduces the potential for tangling because there is less friction and line slap during a cast, especially in the area around the first guide.







**HI-SPEED DRAG**

Hi-speed drag is SHIMANO's fastest drag system and can change the drag setting from free-spool mode to fighting mode with only a very small turn to the knob located on the front of the spool.

**BENEFIT**

A very accurate and user-friendly free spool system. The angler can change the drag from free spool to fight settings in a split second. This provides optimal control and quick handling during the take and whilst playing a fish.



**INSTANT-DRAG**

SHIMANO Instant-Drag allows a quick adjustment of the front drag knob to take the reel from a current drag setting to free spool in just half a turn (and vice-versa).

**BENEFIT**

A very accurate and user-friendly free spool system. The angler can change the drag from free spool to fight settings in only a split second. This provides optimal control and quick handling during the take and the fight of a fish. It only takes a half turn (180 degrees) of the drag knob to close the drag. It's incredibly simple, accurate and easy to use.



**SPOOL REDUCERS**

Spool reducers are plastic bands which are included with some reels (usually reels with a big spool capacity). They can be clicked on the spool, in order to reduce the spool capacity.

**BENEFIT**

Spool reducers reduce the line capacity of the spool preventing excessive use of additional line to achieve the correct spooling profile.



**RIGID CAST**

Rigid Cast technology balances strength and lightness of the main shaft to withstand the impact of extreme casting force.

**BENEFIT**

Rigid Cast technology reduces deflection of the main shaft during extreme casting. This helps improve casting performance and especially accuracy by optimising the timing of the line release.

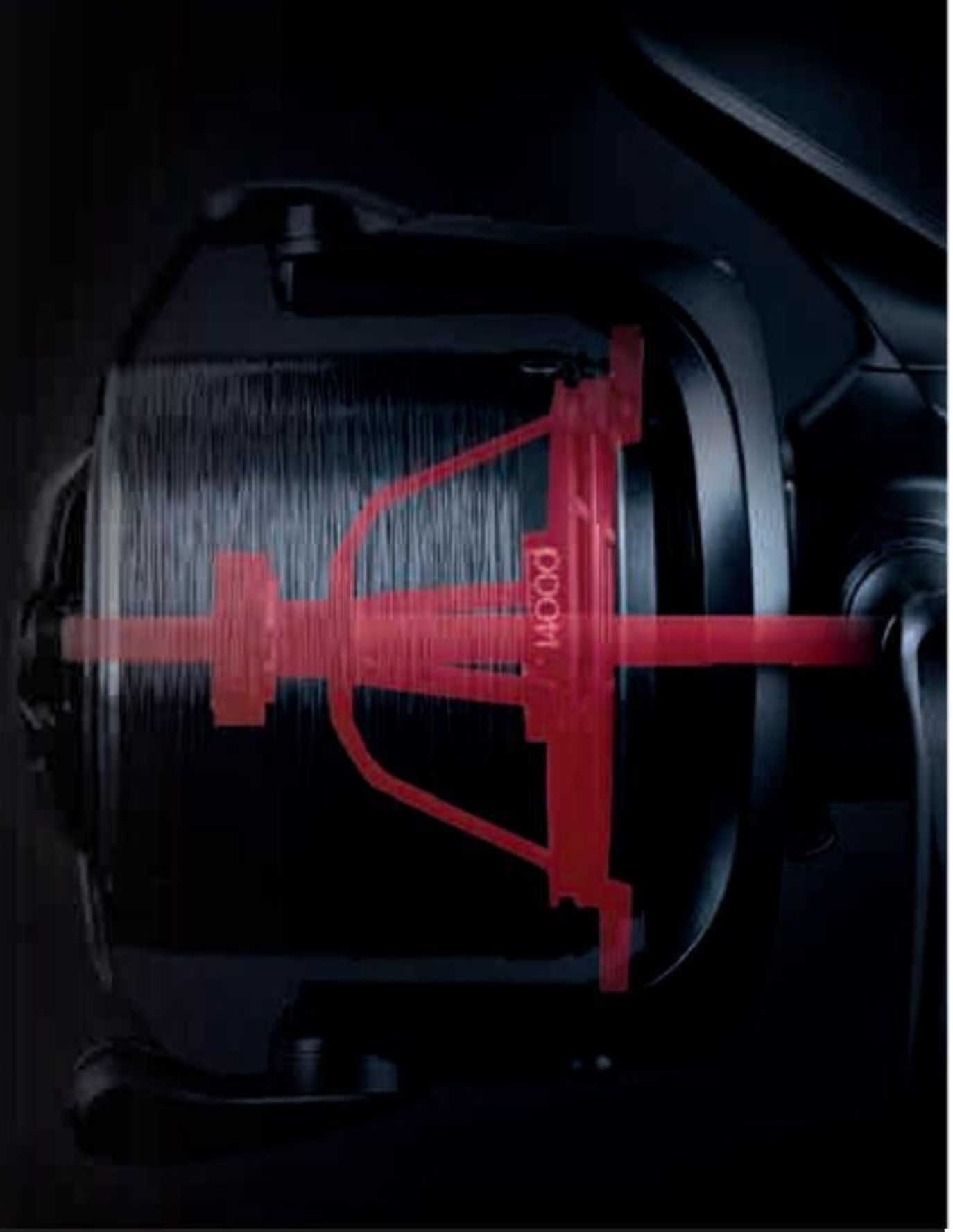

**OSCILLATION**

Slower spool oscillation reduces the speed the line travels up and down the spool on the cast. This results in less friction as line leaves the spool and reduced drag on the lead, which improves casting distance and accuracy.



**STANDARD OSCILLATION**

Up to 20 wraps per cycle. Outperforms the industry standard.



**SLOW OSCILLATION**

Up to 35-40 wraps per cycle. This slow oscillation exceeds almost all other manufacturers reels.



**SUPER SLOW 5**

A minimum of 45-55 wraps per cycle. This makes almost perfect parallel spooling possible and gives a huge improvement in casting distance and precision.



**SUPER SLOW 10**

A minimum of 95-110 wraps per cycle. This produces parallel line spooling and the best casting distance, control and precision possible.

# CAST FAR CAST ACCURATE

NEW

## AERO TECHNIUM MGS

- Magnesium Body and Ci4+ Rotor dramatically reduce weight while retaining the best in body strength and rigidity
- Smooth and powerful winding through HAGANE Gearing, X-SHIP, InfinityDrive and SilentDrive
- Rigid cast for increased shaft strength, less vibration and line on spool friction for the most powerful casts
- 45mm spool design in conjunction with Super Slow Speed 10 (107 Wraps) oscillation offers the next generation in casting distance potential
- Single-machined, wind-into-gear folding handle, for zero play in use and transportation
- Matching spare spool supplied including 3 different depth line reducers, per spool

**SIZES:** 14000

**BEARINGS:** 8 + 1

**OSCILLATION:** Super Slow 10 + Aero Wrap

**HANDLE:** Single Aluminium

**SPARE SPOOL:** 1 x Cold Forged Aluminium

XTD



XSD



**SPOOL REDUCER**

3500 - Shallow line reducers x2	0.20mm-200m
6000 - Shallow line reducers x2	0.30mm-200m
10000 - Shallow line reducers x2	0.40mm-300m

ARTCMGS14000XSD	510	4.3:1	0.35mm-550m	103	20	RD21869
ARTCMGS14000XTD	510	4.3:1	0.35mm-550m	103	20	RD21937



14000XTD

14000XSD



# EXTREMELY LIGHT

## *FLIEGEN SD*

- Exceptionally lightweight, eye-catching surf reel
- X-Protect prevents water getting into the inner workings of the reel by means of a labyrinth structure which does not impair rotation lightness
- Equipped with X-SHIP and Ci4+ rotor as well as a Hi-Speed drag
- G Free Body and Parallel Body to reduce the amount of line touching the blank when casting

**BEARINGS:** 8 + 1

**OSCILLATION:** Aero Wrap

**HANDLE:** Screw in Single Aluminium



10000

55A60C000





14000XTB

## POWER AERO XTB

- Equipped with innovative technological features like strong HAGANE Gear and HAGANE Body, X-SHIP to provide maximum power and smoothness
- X-Protect prevents water ingress into the inner workings of the reel without reducing winding resistance
- Compact body compared to spool size creates a sleek profile and reduces weight
- The Parallel Body, in combination with the superb line-lay of the Super Slow 5 System, increases casting performance
- Hi-Speed drag, which is even faster than Instant Drag, enables you to switch instantly from a free running spool to fighting mode with only a very small turn of the drag knob

**SIZES:** 14000

**BEARINGS:** 8 + 1

**OSCILLATION:** Super Slow 5 + Aero Wrap

**HANDLE:** Screw in Single Aluminium

**SPARE SPOOL:** 1 x Cold Forged Aluminium



### SPOOL REDUCER

3500 - Shallow line reducers x2	0.20mm-200m
6000 - Shallow line reducers x2	0.30mm-200m
10000 - Shallow line reducers x2	0.40mm-300m

PA14000XTB | 510 | 4.3:1 | 0.35mm-550m | 103 | 20 | RD18606



14000XSB

## POWER AERO XSB

- Equipped with innovative technological features like strong HAGANE Gear and HAGANE Body, X-SHIP to provide maximum power and smoothness
- X-Protect prevents water ingress into the inner workings of the reel without reducing winding resistance
- Compact body compared to spool size creates a sleek profile and reduces weight
- The Parallel Body, in combination with the superb line-lay of the Super Slow 5 System, increases casting performance
- Hi-Speed drag, which is even faster than Instant Drag, enables you to switch instantly from a free running spool to fighting mode with only a very small turn of the drag knob

**SIZES:** 14000

**BEARINGS:** 8 + 1

**OSCILLATION:** Super Slow 5 + Aero Wrap

**HANDLE:** Screw in Single Aluminium

**SPARE SPOOL:** 1 x Cold Forged Aluminium



### SPOOL REDUCER

3500 - Shallow line reducers x2	0.20mm-200m
6000 - Shallow line reducers x2	0.30mm-200m
10000 - Shallow line reducers x2	0.40mm-300m

PA14000XSB | 510 | 4.3:1 | 0.35mm-550m | 103 | 20 | RD18571

# BIG PIT REELS



9100

## BULL'S EYE

- A true workhorse surf casting reel with immense winding power making it ideal for large leads or rough ground fishing
- Ideal for long distance casting with heavy leads
- Hi-torque gear ratio of 3.5:1 creates massive cranking power
- Aero Wrap II produces excellent line lay for increased casting performance
- Shallow spool is ideal for both braid and mono lines

**BEARINGS:** 5 + 1

**OSCILLATION:** Slow Oscillation + Aero Wrap

**HANDLE:** Screw in Single Aluminium



5SE44A910	540	3.5:1	0.50mm-215m	84	20	03273-0008
5SE44A912	540	3.5:1	0.50mm-260m	84	20	03274-0111



14000

## SURF LEADER C14+ SD

- Designed for ultra long surf casting with thin braided lines
- X-Protect technology gives high level water protection, ensuring excellent performance whilst retaining lightweight rotation
- Parallel Body design with Slow Oscillation for increased distance casting performance
- Hi-Speed Drag can be adjusted from zero to maximum drag in just one turn of the control knob
- Shallow spool (0.20mm - 250m) for fine diameter lines
- G Free body for improved balance
- AR-C cold forged aluminium spool

**BEARINGS:** 4 + 1

**OSCILLATION:** Aero Wrap

**HANDLE:** Screw in Single Aluminium



51SA62E000A	535	3.5:1	0.25mm-260m	84	20	03893-0211
-------------	-----	-------	-------------	----	----	------------



14000XTC



14000XSC

## ULTEGRA Ci4+ XTC

- Ci4+ delivers a substantial weight saving on the compact body making rod speed easier to generate when distance casting
- Super Slow 5 Oscillation (14000), Slow (5500) line lay and an AR-C spool fitted with Hi-Speed drag mechanism increase casting performance
- X-Protect will guarantee to protect the reel's inner parts against intrusion from water and dirt
- G Free Body in combination with Parallel Body will help to achieve long and accurate casts without unnecessary fatigue
- The very compact body design contributes to the excellent balance of this compact, lightweight big pit reel

**SIZES:** 5500, 14000

**BEARINGS:** 5 + 1

**OSCILLATION:** Super Slow 5 + Aero Wrap (14000),  
Slow + Aero Wrap (5500)

**HANDLE:** Single Aluminium

**SPARE SPOOL:** 1 x Cold Forged Aluminium



**SPOOL REDUCER**

3500 - Shallow line reducers x2	0.20mm-200m
6000 - Shallow line reducers x2	0.30mm-200m
10000 - Shallow line reducers x2	0.40mm-300m

ULTCi45500XTC	440	5.3:1	0.30mm-390m	105	15	RD18814
ULTCi414000XTC	540	4.3:1	0.35mm-550m	103	20	RD18515

## ULTEGRA Ci4+ XSC

- Ci4+ delivers a substantial weight saving on the compact body making rod speed easier to generate when distance casting
- Super Slow 5 Oscillation (14000), Slow (5500) line lay and an AR-C spool fitted with Hi-Speed drag mechanism increase casting performance
- X-Protect will guarantee to protect the reel's inner parts against intrusion from water and dirt
- G Free Body in combination with Parallel Body will help to achieve long and accurate casts without unnecessary fatigue
- The very compact body design contributes to the excellent balance of this compact, lightweight big pit reel

**SIZES:** 5500, 14000

**BEARINGS:** 5 + 1

**OSCILLATION:** Super Slow 5 + Aero Wrap (14000),  
Slow + Aero Wrap (5500)

**HANDLE:** Single Aluminium

**SPARE SPOOL:** 1 x Cold Forged Aluminium



**SPOOL REDUCER**

3500 - Shallow line reducers x2	0.20mm-200m
6000 - Shallow line reducers x2	0.30mm-200m
10000 - Shallow line reducers x2	0.40mm-300m

ULTCi45500XSC	440	5.3:1	0.30mm-390m	105	15	RD18799
ULTCi414000XSC	540	4.3:1	0.35mm-550m	103	20	RD18489

# X-SHIP GEARING

## ULTEGRA XTD

- X-SHIP gearing for maximum winding power and efficiency even under pressure
- Slow Oscillation with Aero Wrap for amazing casting performance
- AR-C spool also increases distance casting
- Parallel Body design ensures reel is perfectly positioned for distance casting
- Super fast Instant Drag spool system (only one turn required from on to off)
- Supplied with 1 spare Cold Forged Aluminium spool and 4 line reducers

**SIZE:** Spod, 5500

**BEARINGS:** 4 + 1

**OSCILLATION:** Slow (5500) Super Slow 5 (Spod) + Aero Wrap

**HANDLE:** Single Aluminium

**SPARE SPOOL:** 1 x Cold Forged Aluminium



**SPOOL REDUCER**

(5500) 3500 - Shallow line reducers x2 | 0.20mm-200m  
 (5500) 4500 - Shallow line reducers x2 | 0.35mm-220m

ULT5500XTD	500	5.3:1	0.30mm-390m	105	15	RD17987
ULTSPODXTD	630	5.2:1	0.30mm-390m	124	20	RD18828





# AMAZING CASTING

## ULTEGRA XSD

- X-SHIP gearing for maximum winding power and efficiency even under pressure
- Slow Oscillation with Aero Wrap for amazing casting performance
- AR-C spool also increases distance casting
- Parallel Body design ensures reel is perfectly positioned for distance casting
- Super fast Instant Drag spool system (only one turn required from on to off)
- Supplied with 1 spare Cold Forged Aluminium spool and 4 line reducers

**SIZE:** 3500 Comp, 5500

**BEARINGS:** 4 + 1

**OSCILLATION:** Slow (5500), Super Slow 5 (3500 Comp) + Aero Wrap

**HANDLE:** Single Aluminium

**SPARE SPOOL:** 1 x Cold Forged Aluminium

3500 Comp only



### SPOOL REDUCER

(5500) 3500 - Shallow line reducers x2



0.20mm-200m

(5500) 4500 - Shallow line reducers x2

0.35mm-220m

UL35XSDCOMP



645



4.3.1



0.20mm-200m



103



20



RD17927

ULT5500XSD

500

5.3.1

0.30mm-390m

105

15

RD18006



35XSDCOMP

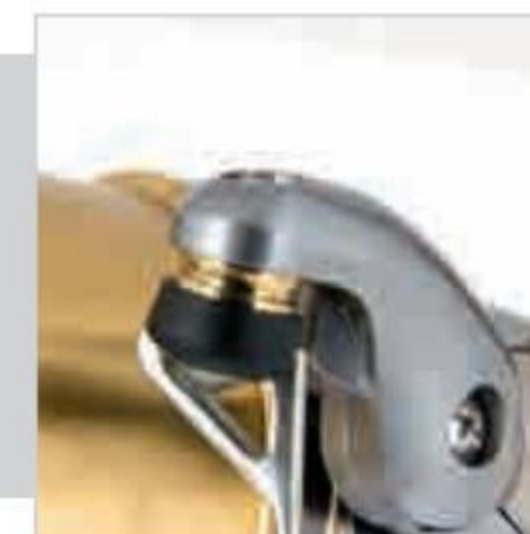

# MASTER YOUR SPEED

## *SpeedMaster* **XTC | XSC**

- X-SHIP gearing for efficient winding power
- Parallel Body design with Super Slow 5 Oscillation for increased distance casting performance
- G Free body for improved balance
- AR-C cold forged aluminium spool
- Instant Drag can be adjusted from zero to maximum drag in just one turn of the control knob
- Aero Wrap for excellent line lay and improved casting performance
- 4.3:1 gear ratio retrieves 103cm of line per handle turn

**SIZES:** 14000

**BEARINGS:** 4 + 1

**OSCILLATION:** Super Slow 5 + Aero Wrap

**HANDLE:** Single Aluminium



**SPOOL REDUCER**

3500 - Shallow line reducers x1

10000 - Shallow line reducers x1

 0.20mm-200m  
0.40mm-300m

							
SPM14000XTC	625	4.3.1	0.35mm-550m	103	20	RD19325	
SPM14000XSC	625	4.3.1	0.35mm-550m	103	20	RD19293	





1000XTB



## AERLEX XTB

- Outstanding value for money and quality
- Aero Wrap and an AR-C spool combine to add casting distance
- 4.6:1 gear ratio (10000 size) provides strong winding power
- Special high speed 5.3:1 (Spod version) retrieves 115cm of line per handle turn
- Instant Drag allows simple depth finding with a marker due to half turn free spool adjustment

**BEARINGS:** 2 + 1 | **OSCILLATION:** 2 Speed + Aero Wrap

	g	Ratio	Line Capacity	Retrieval	Spool	RD
ALX10000XTB	645	4.6:1	0.40mm-300m	100	15	RD17909
ALX10000XTBSP	650	5.3:1	0.40mm-300m	115	15	RD17921



1000XSB



## AERLEX XSB

- Heavy duty sea reel that is perfectly suited to surf casting
- SHIMANO's Instant Drag allows for quick adjustment of the drag for locking up on powerful casts
- Aero Wrap line lay and an AR-C spool for good casting performance
- A high torque retrieve ratio of 4.6:1 gives the reel power to cope with heavy leads and rough ground

**BEARINGS:** 2 + 1 | **OSCILLATION:** 2 Speed + Aero Wrap

	g	Ratio	Line Capacity	Retrieval	Spool	RD
ALX10000XSB	645	4.6:1	0.40mm-300m	100	15	RD17892



1000XB



## BeastMaster XB

- Heavy duty sea reel that is perfectly suited to surf casting as well as carp fishing
- SHIMANO's Instant Drag allows for quick adjustment of the drag for locking up on powerful casts
- Aero Wrap line lay and an AR-C spool for good casting performance
- A high torque retrieve ratio of 4.6:1 gives the reel power to cope with heavy leads and rough ground

**BEARINGS:** 1 + 1 | **OSCILLATION:** 2 Speed + Aero Wrap

	g	Ratio	Line Capacity	Retrieval	Spool	RD
BMBP10000XB	705	4.6:1	0.35mm-400m	100	15	RD18787



## FREESPOOL REELS

The SHIMANO BAITRUNNER Freespool system was developed over 30 years ago and has become the first choice for many carp and specimen anglers throughout the world.

BAITRUNNER is a registered trademark of SHIMANO and can not be used by any other company.





54	BAITRUNNER Ci4+ XTB LC	
56	BAITRUNNER XTB LC	
57	BAITRUNNER X-AERO FB	<b>NEW</b>
	BAITRUNNER X-AERO RA	
	BAITRUNNER D	
58	BAITRUNNER OC	
	BAITRUNNER DL FB	
	BAITRUNNER ST FB	
59	BAITRUNNER XT RB	
	BAITRUNNER DL RB	
	BAITRUNNER ST RB	



# THE LEGEND GOES ON

## BAITRUNNER C14+ XTB-LC

- The oversized, lightweight C14+ BAITRUNNER reel provides a massive weight saving, bringing it into the high-end Big Pit performance casting category
- Unsurpassed X-SHIP technology makes the reel ultra smooth and delivers enormous cranking power even under extreme pressure
- Aero Wrap combined with Slow Speed oscillation provides excellent line lay for easier and longer casting
- AR-C spool for increased casting performance
- Instant Drag spool for fish-playing control
- Features a stamping bail to eliminate line wrap
- Line retrieve per handle turn: Medium - 105cm, Big - 110cm

**SIZES:** Medium & Big

**BEARINGS:** 6 + 1

**OSCILLATION:** Two-speed Slow Speed + Aero Wrap

**HANDLE:** Screw in Single Aluminium

**SPARE SPOOL:** 1 x Cold Forged Aluminium



**SPOOL REDUCER BIG**

3500 - Shallow line reducer x2	0.20mm-200m
10000 - Shallow line reducer x2	0.40mm-300m

**SPOOL REDUCER MEDIUM**

3500 - Shallow line reducer x2	0.20mm-200m
4500 - Shallow line reducer x2	0.35mm-220m

MBTRC14XTBLC	510	5.3:1	0.40mm-210m	105	15	RD18814
BBTRC14XTBLC	640	4.6:1	0.35mm-550m	110	20	RD18515



14000 C14 XTBLC



# MINIMAL FRICTION

## BAITRUNNER XTB-LC

- A large AR-C spool system with Slow oscillation in combination with the Aero Wrap II line lay system ensures maximum distance casting performance
- X-SHIP system for a smooth power transfer and stability of the gears thanks to the two-point support of the pinion gear by ball bearings
- The gears have been redesigned to minimise friction and increase power transfer from the long aluminum handle to the rotor. This delivers more torque and winding power making fish playing easier and delivering more control
- Available in two sizes: the big size is perfect for the larger carp waters whilst the medium version is the ideal choice for medium sized waters where casting distance is not the most important requirement

**SIZES:** Medium and Big

**BEARINGS:** 4 + 1

**OSCILLATION:** Slow Speed + Aero Wrap

**HANDLE:** Screw in Single Aluminium



**SPOOL REDUCER BIG**

3500 - Shallow line reducer x1 0.20mm-200m  
 10000 - Shallow line reducer x1 0.40mm-300m

**SPOOL REDUCER MEDIUM**

3500 - Shallow line reducer x1 0.20mm-200m  
 4500 - Shallow line reducer x1 0.35mm-220m

	g	Ratio	Line	Ret	Spool
MBTRXTBLC	560	5.3:1	0.35mm-290m	105	15 RD18394
BBTRXTBLC	720	4.6:1	0.40mm-400m	110	20 RD18426



Big XTBLC







NEW



## BAITRUNNER X-AERO

- Compact BAITRUNNER featuring a large diameter AR-C spool
- X-SHIP gearing for powerful efficient winding
- Shielded Anti-Rust bearings (S A-RB)
- Smooth low-inertia front drag for superior fish-playing
- Double handle provides excellent rotational balance
- Cold forged aluminium AR-C spare spool

**BEARINGS:** 4 + 1

**OSCILLATION:** Two-speed Slow Speed Oscillation

BTRXAR4000FB	420	4.8:1	0.25mm-260m	86	8	RD22244
--------------	-----	-------	-------------	----	---	---------



## BAITRUNNER X-AERO

- BAITRUNNER reel with oversized large diameter Aero Concept spool for increased casting performance
- 8000 and 10000 sizes have single handle for increased power, 6000 size has balanced double handle
- 4.6:1 gear ratio delivers increased winding power
- Aero Wrap and 2-speed oscillation provides outstanding line lay

**BEARINGS:** 6 + 1 (8000, 10000) 8 + 1 (6000)

**OSCILLATION:** Two-speed Slow Speed Oscillation

BTXAR6000RA	615	4.6:1	0.30mm-320m	96	5	RD16700
BTXAR8000RA	580	4.6:1	0.35mm-290m	96	5	RD16731
BTXAR10000RA	590	4.6:1	0.40mm-260m	99	5	RD16735



## BAITRUNNER D

- An extremely powerful and robust front drag BAITRUNNER available in a range of sizes to suit most applications
- Other features include cold forged Aluminium spool and gear, waterproof drag, one piece bail and a maintenance port

**BEARINGS:** 3 + 1

BTR4000D	385	4.8:1	0.35mm-130m	71	7	RD13525
BTR6000D	570	4.8:1	0.40mm-140m	89	9	RD13238
BTR8000D	615	4.8:1	0.40mm-230m	91	9	RD13196
BTR12000D	850	4.4:1	0.40mm-320m	93	12	RD13575
BTR6000DEU (EU)	550	4.8:1	0.40mm-140m	89	9	RD13238
BTR8000DEU (EU)	600	4.8:1	0.45mm-230m	91	9	RD13196



8000OC



## BAITRUNNER OC

- An affordable heavy duty BAITRUNNER
- AR-C spool with Varispeed line lay for improved casting performance
- Dynabalance reduces reel wobble
- 12000 size suitable for catfish, 8000 and 6000 for carp and 4000 for barbel and bass
- Line retrieve per handle turn: size 4000 - 71cm, size 6000 - 89cm, size 8000 - 91cm, size 12000 - 93cm

**BEARINGS:** 3 + 1

BTR4000OC	380	4.8:1	0.35mm-130m	71	7	RD15103
BTR6000OC	545	4.8:1	0.40mm-140m	89	9	RD15112
BTR8000OC	590	4.8:1	0.40mm-230m	91	9	RD15123
BTR12000OC	825	4.8:1	0.45mm-240m	93	12	RD15133



DL4000FB



## BAITRUNNER DL

- XT-7 body and rotor keeps body weight to a minimum
- Double handle gives excellent balance and superb winding power
- 4.8:1 retrieve ratio and diecast gear for extra power and torque
- Line retrieve per handle turn: size 2500 - 68cm, size 4000 - 75cm
- Ideally suited to smaller specimen and specialist angling applications, including carp and barbel fishing as well as deadbaiting for predatory species

**BEARINGS:** 3 + 1

BTRDL2500FB	360	4.8:1	0.25mm-160m	68	3	RD17056
BTRDL4000FB	415	4.8:1	0.30mm-180m	75	6	RD17063



ST4000FB



## BAITRUNNER ST

- Very affordable, entry-level small BAITRUNNER suited to commercial fisheries and all specialist angling
- Varispeed oscillation results in excellent line lay for better casting and smother fish playing drag
- Super Stopper II technology eliminates any fall back of the reel handle when setting tips
- XT-7 body and rotor keeps weight to a minimum
- Line retrieve per handle turn: size 2500 - 68cm, size 4000 - 75cm

**BEARINGS:** 1 + 1

BTRST2500FB	310	4.8:1	0.25mm-160m	68	3	RD16826
BTRST4000FB	355	4.8:1	0.35mm-130m	75	6	RD16830



XT8000RB



## BAITRUNNER XT

- Stunning understated black cosmetics with additional chrome detailing
- Aero Wrap and 2-speed oscillation providing outstanding line lay for smoother and longer casting
- AR-C spool for increased casting performance
- Hybrid XT-7 and Aluminium body for strength and reduced weight
- Dynabalance gives excellent balance when retrieving at high speed
- Line retrieve per handle turn: size 6000 - 85cm, size 10000 - 88cm

**BEARINGS:** 4 + 1 | **OSCILLATION:** 2 Speed Oscillation

	g	Ratio	Line Capacity	Retrieval	Spool	RD
BTRXT6000RB	610	4.6:1	0.30mm-320m	85	6	RD15213
BTRXT10000RB	610	4.6:1	0.40mm-260m	88	6	RD15227



DL10000RB



## BAITRUNNER DL

- Understated graphics designed for the specimen angler
- Powerful 4.6:1 gear ratio for excellent fish-playing control
- Balanced double handle on both models
- AR-C cold forged aluminum spool
- Varispeed oscillation produces excellent line lay
- Line retrieve per handle turn: size 6000 - 85cm, size 10000 - 87cm

**BEARINGS:** 3 + 1

	g	Ratio	Line Capacity	Retrieval	Spool	RD
BTRDL6000RB	590	4.6:1	0.30mm-270m	85	6	RD17086
BTRDL10000RB	595	4.6:1	0.35mm-350m	87	6	RD17091



ST10000RB



## BAITRUNNER ST

- Entry-level BAITRUNNER reel in 6000 and 10000 size
- Balanced double handle on both models
- XT-7 body and rotor with understated black cosmetics
- 4.6:1 gear ratio delivers extra winding power
- Super Stopper II for instant and infinite anti-reverse
- Line retrieve per handle turn: size 6000 - 85cm, size 10000 - 87cm

**BEARINGS:** 1 + 1

	g	Ratio	Line Capacity	Retrieval	Spool	RD
BTRST6000RB	550	4.6:1	0.30mm-270m	85	6	RD16818
BTRST10000RB	555	4.6:1	0.35mm-350m	87	6	RD16822



## BAITCASTING REELS

Baitcasting reels are increasing in popularity as more anglers turn to predator fishing throughout Europe. Lightweight design, combined with exceptionally direct contact make working lures with a Baitcaster or a small multiplier type reel extremely efficient and rewarding. Almost all SHIMANO low and round profile baitcasting reels now feature casting control technology for trouble free use.





62 BAITCASTING TECHNOLOGY

**LOW PROFILE DC**

65 METANIUM DC

66 SLX XT DC **NEW**

68 CURADO DC

69 SLX DC

**LOW PROFILE FTB**

70 ALDERBARAN BFS **NEW**

71 CURADO BFS

**LOW PROFILE SVS**

72 ANTARES MGL

74 ALDERBARAN MGL

METANIUM

75 BANTAM **NEW**

76 CURADO MGL 150/151 **NEW**

CURADO MGL 71

CURADO 200/201

77 SLX MGL

GRAPPLER BB

SLX XT

**LOW PROFILE VBS**

78 TRANX

CURADO 300/301

SLX

79 CAIUS

GENPU XT

**ROUND PROFILE SVS**

80 CALCUTTA CONQUEST

**ROUND PROFILE VBS**

81 CARDIFF

CORVALUS



# BRAKE SYSTEMS

## THE BRAKE IS A INDISPENSABLE PART OF A BAITCASTING REEL.

At the start of the cast, the reel spool has to turn very quickly, while at the end of the cast (when the lure almost hits the water) the spool has to turn a lot slower to prevent an overrun of line. The brake regulates the turning speed of the spool, so it will brake the speed during the cast, preventing knots and making accurate trouble-free casting possible. Setting the drag is a very precise job: too much brake will decrease the casting distance drastically, while not enough brake will cause an overrun of line and resulting tangles.

**DC BRAKE**  
Automatic control of braking force by detecting spool revolution

**CONVENTIONAL BRAKING SYSTEM**  
Braking force changes according to spool rotation speed

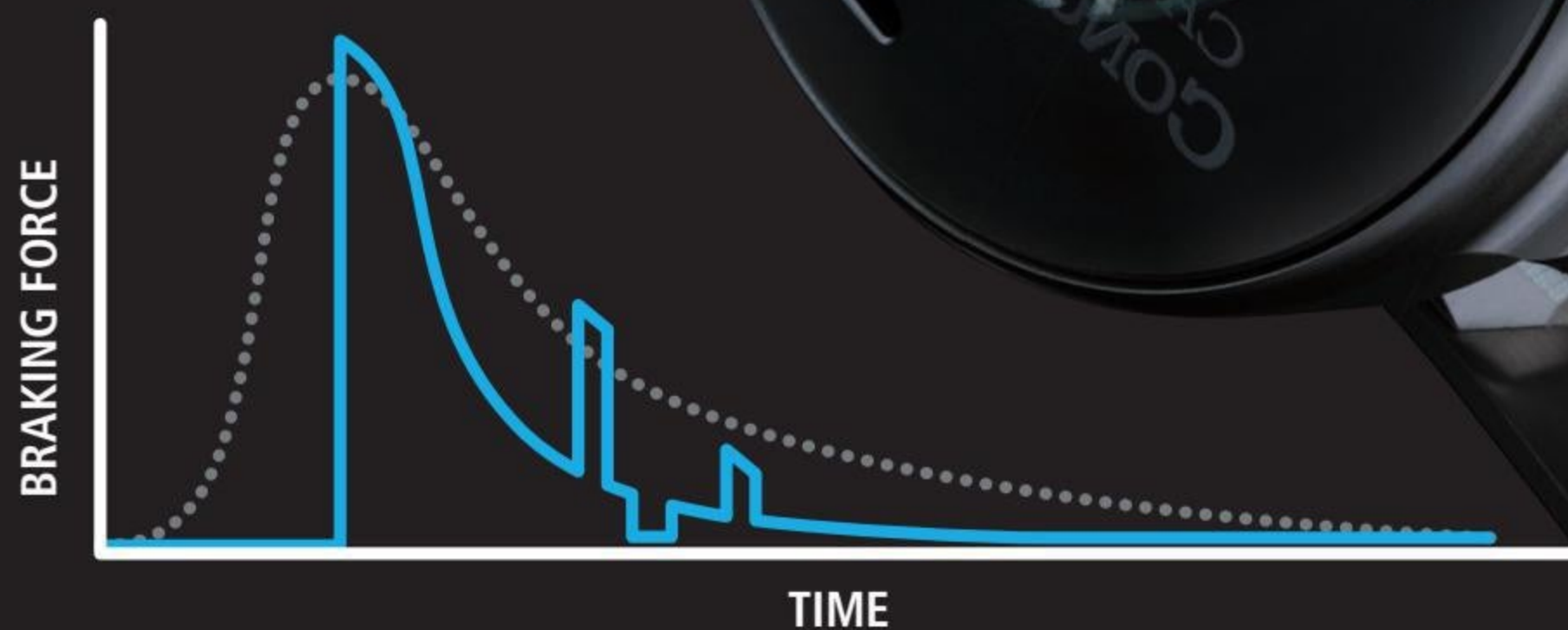

### DIGITAL CONTROL

The Digital Control system is a waterproof, self-energizing system which is computer chip controlled. It recharges with each cast and needs no battery or power source. During the initial moments of the cast, the energy generated by the rotation of the spool is stored in the Digital Control circuit board and powers the Digital Braking System on subsequent casts. During the cast, the Digital Braking system calculates and provides the optimal braking force.

#### BENEFIT

This revolutionary system makes accurate and long distance casting possible, while at the same time minimising tangles, knots and overruns. It anticipates hard casting conditions, like fishing in windy weather or casting very light baits. The DC system produces excellent casting performance for both beginner and tournament anglers.



I-DC5 has 2 sets of dial adjustment. With the internal dial, you can select the type of line used.

The external dial adjustment has a selection of 4 semi-automatic settings, dependent on lure size, plus an 'AUTO' function, letting the onboard DC decide optimal brake setting.



The I-DC4 braking system is an intelligent Digital Control braking system with an easy to use, 4 setting externally adjustable brake dial. This will allow anglers to fish a wide variety of lures, in any conditions, with minimal adjustment to the reel. 4 modes can be set using the external dial.



**SVS INFINITY**

SVS Infinity provides easy-to-manage, consistent spool control and brake force. With brake weights that use 'inner friction' against the raceway during the cast, SVS Infinity controls spool speed for precision casting, especially when using lighter lures. The external adjustment knob provides quick, precise adjustments for either the conditions or when you switch lure size.

**BENEFIT**

SVS Infinity provides an adjustable brake dial to provide a much wider and more precise range for maximum control and consistent brake performance, in all conditions. SVS infinity allows almost 'infinite' precision when casting.

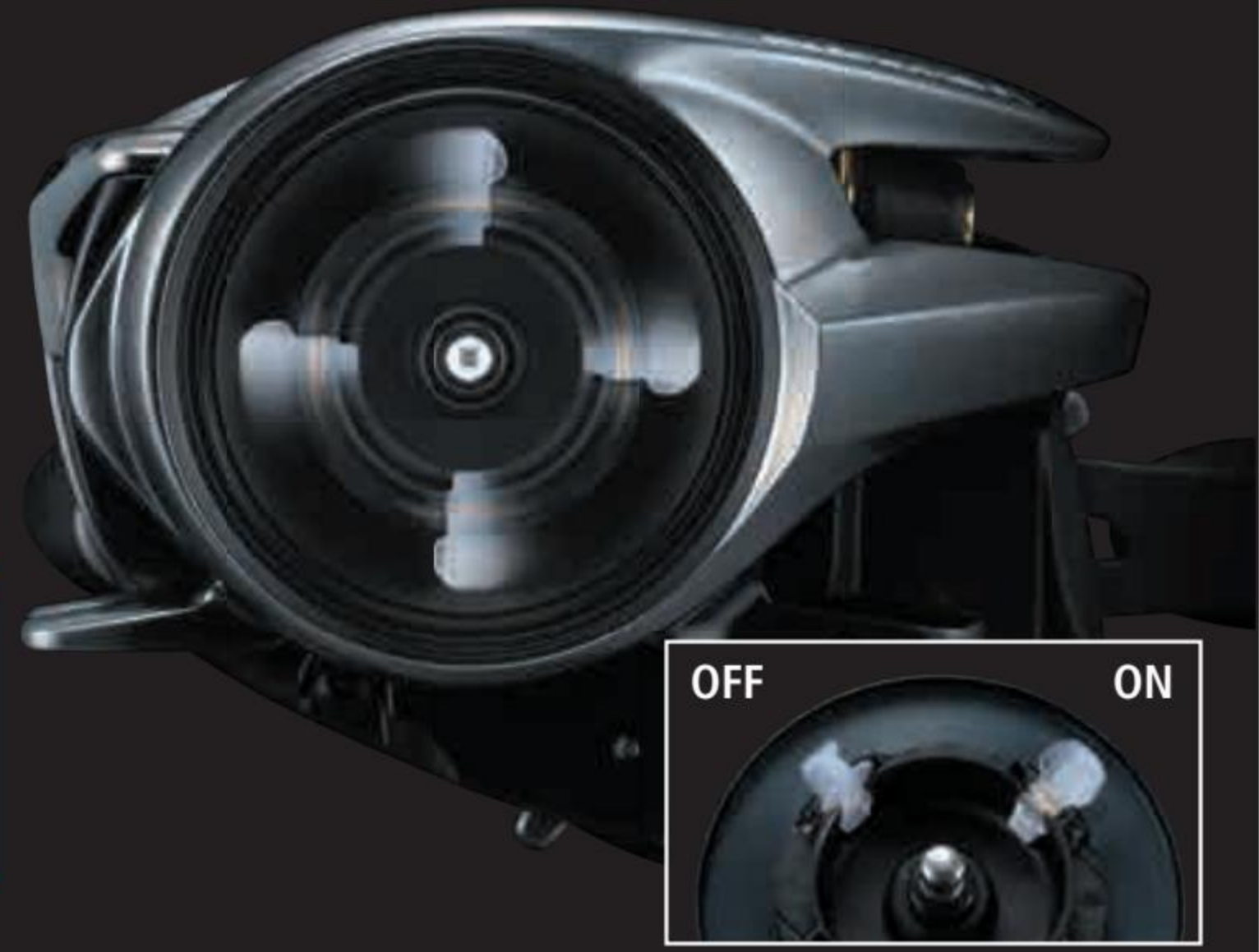

ROUND PROFILE

LOW PROFILE MGL SPOOL

LOW PROFILE



**FINESSE TUNE BRAKE**

FTB is a brake system developed especially for finesse baitcasting reels. The brake unit is usually located on the side of the spool, but the FTB system is outside the spool reducing weight. By turning the knob on the outside of the reel, magnets are moved deeper or shallower into the spool. Deeper means more braking power, shallower means less braking power. This adjusts itself to the rotational speed of the spool during the cast creating the right amount of braking power.

**BENEFIT**

The FTB system biggest advantage is the ultra light spool. The light weight spool enables long and accurate casts to be made with very light lures. The braking system, with the magnets, is extremely sensitive and can be set very precisely for optimal braking power in every situation.



**VBS BRAKING**

VBS uses centrifugal force rather than magnets to aid controlling the cast. When turned on, the individual brake weights are forced outward at the beginning of the cast, when backlashes most often occur, causing friction that reduces the speed of the spool. Once the spool speed begins to slow, the pressure with which the brake weights contact the raceway lessens, allowing the spool to continue spinning and improving the casting distance. VBS braking can only be changed on the inside of the reel, there is no external dial.

**BENEFIT**

The result is a much more consistent spool speed, that is easier to manage and takes advantage of the reel's maximum casting distance. Settings range from zero weights turned on for true free-spool rotation, up to 6 weights turned on for extremely windy conditions and maximum cast control. This means that whatever the circumstances, you will be able to cast efficiently.



ROUND PROFILE

LOW PROFILE

# ROUND PROFILE BAITCASTING REELS - SVS

## LEFT HAND / RIGHT HAND MODELS

Baitcasting reels are left handed or right handed. This is indicated by the number. For example, a reel with size 200 is right handed, a reel with size 201 is left handed. Left handed means the turning of the handle is done with the left hand, so the rod is the anglers' right hand. A left handed reel is used by most European anglers.



## MAGNUMLITE SPOOL

The lightweight MGL Spool features reduced spool inertia, for improved casting distance and accuracy with lighter lures.

### BENEFIT

A lighter spool means that it becomes easier to cast lighter lures on thinner lines. The addition of a MGL Spool offers increased versatility across a wider range of lure sizes.



## CORESOLID BODY

The CoreSolid Body, which is featured on some bait casting reels, integrates the B-Side Plate, level wind guard and frame into one solid once piece construction.



### BENEFIT

This CoreSolid Body delivers an unprecedented feeling of rigidity and sensitivity, and is the first design of this type in a low profile baitcasting reel.



## S3D SPOOL

SHIMANO's S3D technology leads to significantly reduced spool vibration. By designing a balanced and uniform thin wall aluminium constructed spool, S3D creates an incredibly smooth feeling when casting and retrieving lures.



### BENEFIT

Improved feeling of the reel due to a reduction in vibration when casting and retrieving.

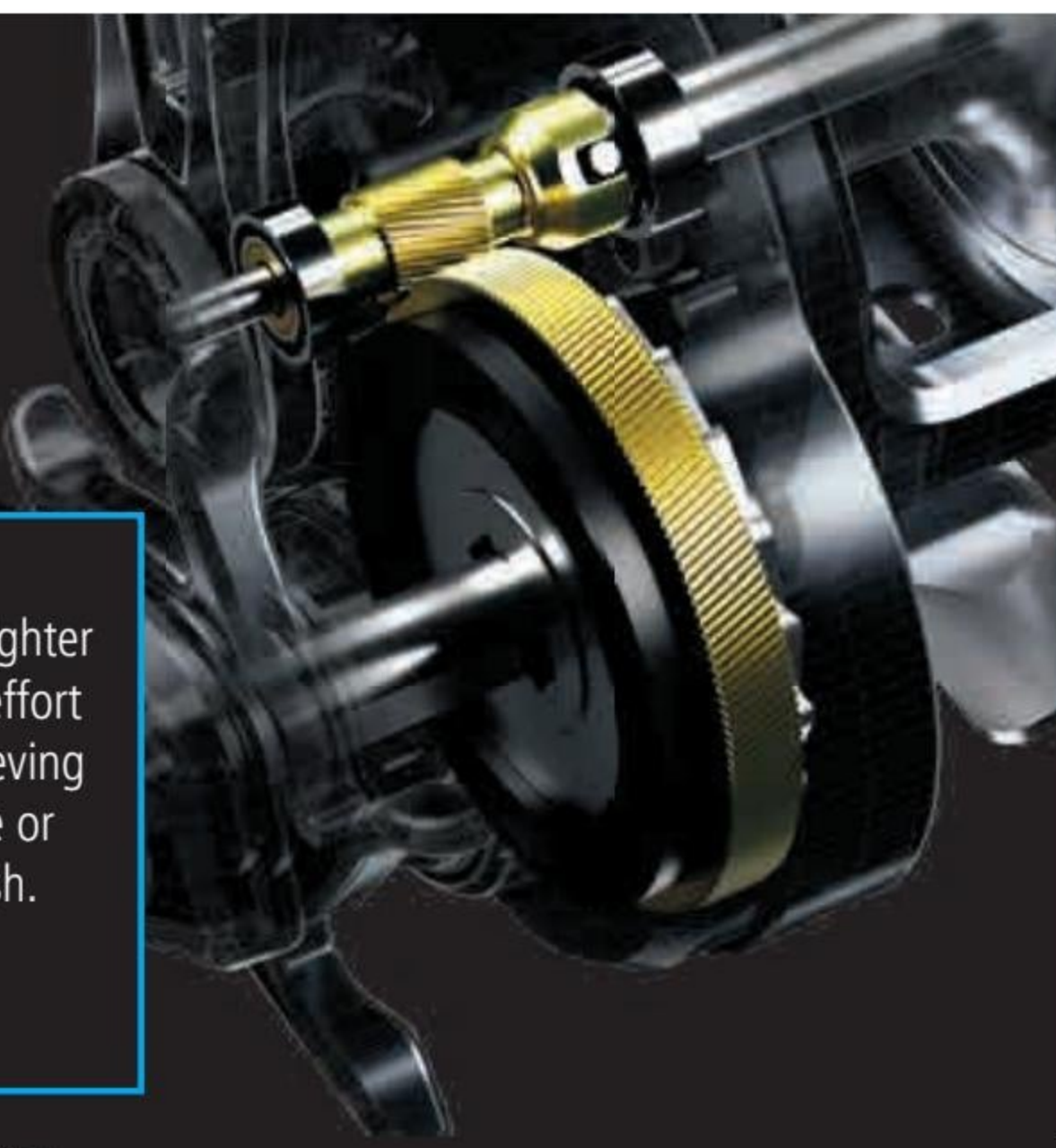

### BENEFIT

More powerful and lighter winding means less effort is needed when retrieving a high-resistance lure or fighting with a big fish.

## INFINITYDRIVE

InfinityDrive is a mechanism developed by SHIMANO that achieves more powerful and lighter winding. By changing the supporting pinion gear, rotational resistance is drastically reduced compared to our conventional products without reducing the gear strength.

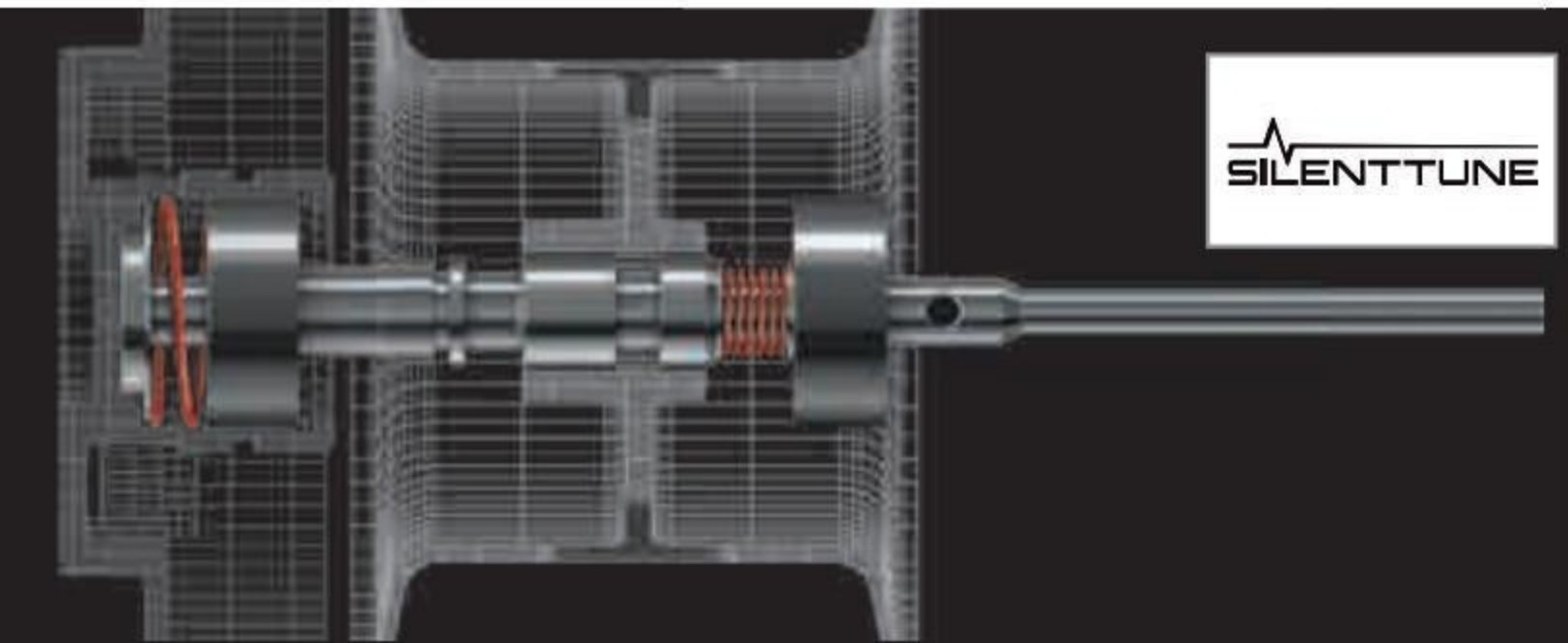

## SILENT TUNE

Silent Tune is an advanced SHIMANO technology. As with any casting reel, the spool rides on bearings. These bearings have pockets in the frame or side plates which house the bearings and are given some tolerance in order to make the bearings more easily changeable. While the tolerance is necessary, it allows the bearings to move slightly during casting, leading to the smallest of vibrations that take energy away from the core of the reel and reduce the distance and smoothness of the cast. Silent Tune technology adds small springs under the bearings which keep the bearings in place, ensuring proper alignment and eliminating any movement or vibration that may occur.

### BENEFIT

The pockets / spaces which were necessary to change the bearings have been removed, whilst retaining the possibility to change the bearings. This technology makes smoother, longer casts possible due to the elimination of vibration.



## SUPER FREE SPOOL

Super Free was designed to eliminate friction on the spool shaft during the cast. In standard baitcasting reels, when the clutch bar is pressed down, the pinion gear is freed and can drag on the spool shaft creating friction that can limit the length of a cast. With SF, the pinion gear is supported by a ball bearing so that when the clutch is disengaged in preparation for a cast, the pinion gear and spool shaft are kept in perfect alignment.

### BENEFIT

Super Free ensures there is zero friction upon the spool shaft. This not only improves casting distance, it also improves the entire feeling of the reel when in use.



# ULTIMATE CONTROL

## *Metanium DC*

- Very low weight baitcasting reel with magnesium HAGANE Body, perfect for lures ranging from as light as 5g up to as large as 30g crankbaits
- Highly advanced I-DC5 digital control system for the ultimate in casting control - 15 different settings based on either the line type or lure weight
- MicroModule and X-SHIP gearing delivers remarkable smoothness combined with ultra positive operation
- S3D Spool for reduced vibration when casting
- Auto casting adjustment functions

**SIZES:** 100, 101

**BEARINGS:** 9 + 1

**HANDLE:** Double Handle with Paddles



METDC100HG	190	7.4:1	0.25mm-150m	79	5	BNT5979
METDC101HG	190	7.4:1	0.25mm-150m	79	5	BNT5979
METDC101XG	195	8.5:1	0.25mm-150m	91	5	BNT5979



# REMARKABLY SMOOTH

NEW

## SLX DC XT

- Advanced I-DC5 digital control baitcasting reel designed for small to large lures
- MicroModule and X-SHIP gearing delivers remarkable smoothness combined with ultra positive operation
- With 2 sets of dial adjustment:
  - The inside dial allows you to select the type of line being used: Nylon (Mono), Fluorocarbon, and Braided (PE) Line
  - The outside dial adjustment is based on the lure type: 1. Big Lures, 2. Medium Lures, 3. Small Lures and 4. Finesse Lures. An 'AUTO' function lets the onboard DC decide the optimal brake setting
- No batteries are required, the spool rotation creates electricity to power the micro computer
- HAGANE Body for lightweight strength
- S3D Spool for reduced vibration when casting
- Level wind for trouble free line lay

**SIZES:** 70, 71

**BEARINGS:** 7 + 1

**HANDLE:** Double Handle with Paddles



	g	Ratio	Line	Ret	Speed	Icon
SLXDCXT70HG	195	7.4:1	0.285mm-100m	77	5.5	-
SLXDCXT71	195	6.2:1	0.285mm-100m	64	5.5	-
SLXDCXT71HG	195	7.4:1	0.285mm-100m	77	5.5	-
SLXDCXT71XG	195	8.1:1	0.285mm-100m	84	5.5	-

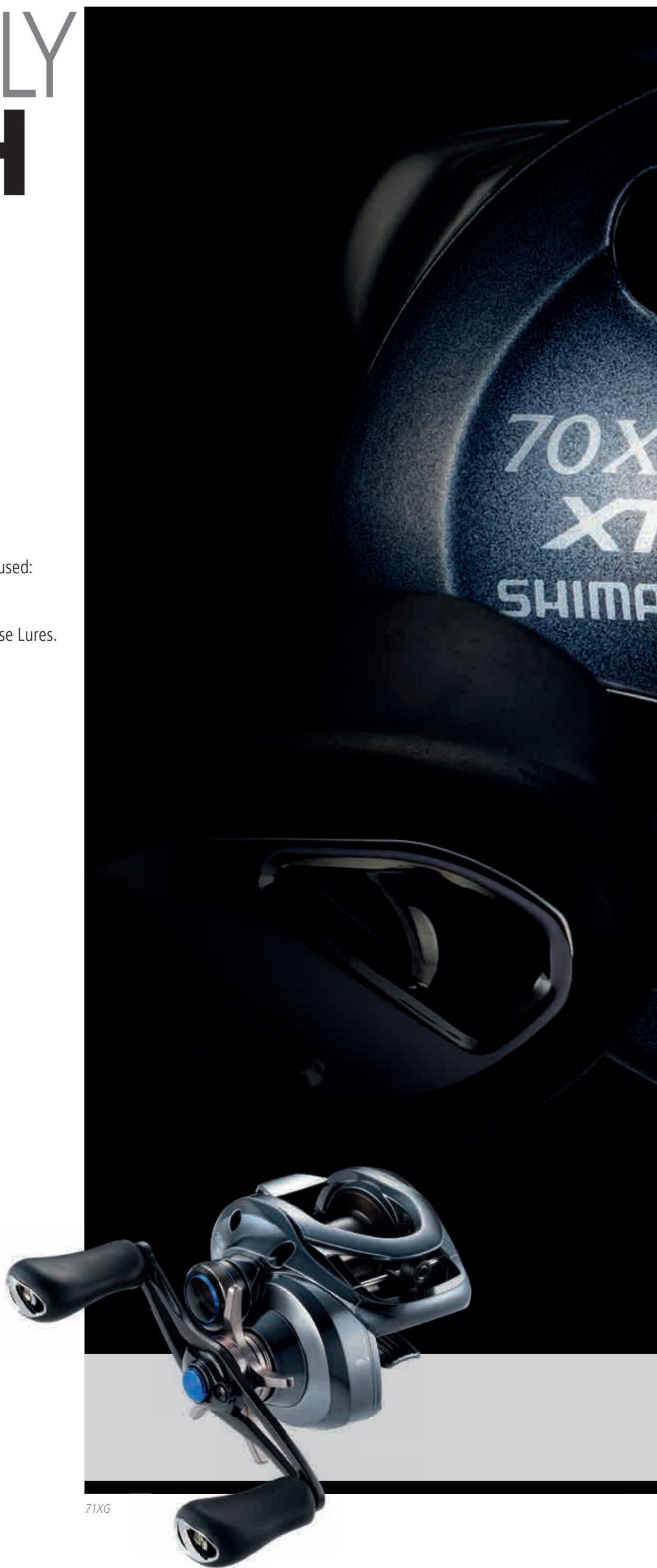

71XG



REEL TECHNOLOGY

FRONT DRAG REELS

REAR DRAG REELS

BIG PIT REELS

FREESPOOL REELS

BAITCASTING REELS

SALTWATER REELS

MULTIPLIERS

# ULTIMATE CASTING

## CURADO DC

- Advanced I-DC4 digital control system for the ultimate in casting control
- MicroModule and X-SHIP gearing delivers remarkable smoothness combined with ultra positive operation
- Maximum drag setting of 5kg for controlling large fish
- Auto casting adjustment functions
  1. Max Distance mode: Best for calm conditions
  2. Braid/mono mode: All-round setting for braid or mono
  3. Fluorocarbon mode: All-round setting for fluorocarbon
  4. Skipping mode: stronger braking when skipping baits

**SIZES:** 150, 151

**BEARINGS:** 6 + 1

**HANDLE:** Double Handle with Paddles



151HG

CUDC150	220	6.2:1	0.33mm-100m	66	5	BNT5900
CUDC151	220	6.2:1	0.33mm-100m	66	5	BNT5900
CUDC151HG	220	7.4:1	0.33mm-100m	79	5	BNT5900
CUDC151XG	225	8.5:1	0.33mm-100m	91	5	BNT5900



# CAST CONTROL

## SLX DC

- Advanced I-DC4 digital control baitcasting reel designed for small to large lures
- Four digital settings control the cast instantly and can be set for maximum distance, braid and mono line, fluorocarbon line and skipping
- No batteries are required, the spool rotation creates electricity to power the micro computer
- HAGANE Body for lightweight strength
- S3D Spool for reduced vibration when casting
- Level wind for trouble free line lay
- Available in three different speed versions to suit personal preference

**SIZES:** 150, 151

**BEARINGS:** 4 + 1

**HANDLE:** Double Handle with Paddles



151HG

SLXDC150	215	6.3:1	10mm-120m	67	5.5	BNT6359
SLXDC151	215	6.3:1	10mm-120m	67	5.5	BNT6359
SLXDC151HG	215	7.2:1	10mm-120m	77	5	BNT6359
SLXDC151XG	215	8.2:1	10mm-120m	88	5	BNT6359



# ULTRA FINESSE

NEW

## ALDEBARAN BFS

- The ultimate SHIMANO ultra finesse baitcasting reel
- Lightweight HAGANE Body crafted from magnesium and Ci4+
- Micromodule Gear and X-SHIP delivers extremely smooth performance
- Advanced FTB (Finesse Tune Brake) reduces casting friction to a minimum
- S3D Spool and SilentTune for reduced vibration when casting
- Exciting Drag Sound for improved fish-playing experience

**SIZES:** HG / XG

**BEARINGS:** 10 + 1

**HANDLE:** Double Handle with Paddles



BFSXGL

	9	9	9	9	9	9
ALDBFSHG	130	7.8:1	0.23mm-50m	71	3.5	-
ALDBFSXGL	130	8.9:1	0.23mm-50m	81	3.5	-



# LIGHT LURE SPECIALIST

## ***CURADO BFS***

- Designed specifically for efficient casting of smaller lures with fine lines
- Compact lightweight HAGANE Body for strength and rigidity
- X-SHIP delivers extremely smooth performance with maximum winding efficiency
- Advanced FTB braking reduces casting friction to a minimum
- S3D Spool for reduced vibration when casting
- Super Free Spool (SF) technology reduces friction on the spool shaft
- Exciting Drag Sound for improved fish-playing experience
- Powerful Cross Carbon Drag

**SIZES:** XG

**BEARINGS:** 7 + 1

**HANDLE:** Double Handle with Paddles



Left

CUBFSXGR	175	8.2:1	0.23mm-50m	82	3.5	BNT6773
CUBFSXGL	175	8.2:1	0.23mm-50m	82	3.5	BNT6773



# SUPER SMOOTH

## ANTARES

- New flagship low profile baitcasting reel
- A versatile model which supports a wide range of lure weights and can handle short to long casts
- HAGANE Body combined with MicroModule gearing and X-SHIP for durable, super smooth performance
- Advanced Magnum Light Spool III that instantly starts rotating, improving casting performance
- Silent tune and S3D spool thoroughly eliminate vibration when the spool rotates, maximising its performance
- SVS and Super Free Spool casting control
- Exciting Drag Sound for improved fish-playing experience

**BEARINGS:** 10 + 1

**HANDLE:** Double Handle with Paddles



5RL173000

9 220 7.4:1 0.285mm-100m 79 5 BNT5876



Right





REEL TECHNOLOGY

FRONT DRAG REELS

REAR DRAG REELS

BIG PIT REELS

FREESPOOL REELS

BAITCASTING REELS

SALTWATER REELS

MULTIPLIERS

# LOW PROFILE BAITCASTING REELS - SVS



51HG



151HG

## ALDEBARAN MGL

- Very light baitcasting reel with Magnesium HAGANE Body, designed for ultra light finesse fishing styles
- Ultra light MGL spool has very low start inertia for improved distance casting and accuracy with light lures
- High drag setting of up to 4.5kg for maximum playing control of large fish
- X-SHIP gearing delivers efficient power transfer from the handle to the spool
- S3D Spool for reduced vibration when casting

**SIZES:** 51

**BEARINGS:** 9 + 1

**HANDLE:** Double Handle with Paddles



	9	6.5:1	0.25mm-100m	65	4.5	BNT5876
ALDMGL51						
ALDMGL51HG		7.4:1	0.25mm-100m	74	4.5	BNT5876

## Metanium

- Magnesium Coresolid Body for extra durability, rigidity and high-end lightweight performance
- Advanced MGL III spool reduces casting inertia by 17% for improved casting performance
- Micromodule drive gear for enhanced durability and long term smoothness
- Ci4+ lightweight star drag
- SVS Infinity braking system for ultimate adjustability
- SHIMANO Silent Tune for reduced spool bearing vibration

**SIZE:** 151

**BEARINGS:** 10 + 1

**HANDLE:** Double Handle with Paddles



	9	6.2:1	0.33mm-100m	66	5	BNT6556
METMGL151B						
METMGL151HGB		7.1:1	0.33mm-100m	76	5	BNT6556
METMGL151XGB		8.1:1	0.33mm-100m	86	5	BNT6556

# SERIOUS ATTITUDE

NEW

## Bantam

- Compact Coresolid aluminium HAGANE Body provides for rigidity
- Micromodule Gear and InfinityDrive deliver powerful light rotation
- MGL III Spool with SVS Infinity braking system
- Star Drag with Cross Carbon Drag washers for powerful control
- Silent Tune and Super Free Spool for reduced casting friction

SIZE: 151

BEARINGS: 8 + 1

HANDLE: Double Handle with Paddles



151HGA



BANTAM151A	215	6.2:1	0.33mm-100m	68	5	BNT7056
BANTAM151HGA	220	7.1:1	0.33mm-100m	78	5	BNT7056
BANTAM151XGA	225	8.1:1	0.33mm-100m	89	5	BNT7056



# LOW PROFILE BAITCASTING REELS - SVS



## CURADO MGL

- Medium sized baitcasting reel for small and medium sized lures
- MGL spool with low inertia improves casting for lightweight lures
- SVS Infinity system offers versatile casting control adjustment
- Compact and lightweight Ci4+ body balances lightweight rods

**BEARINGS:** 6 + 1 | **HANDLE:** Double Handle with Paddles

	g	Ratio	Line	Ret	Drag	Spool
CUMGL150	190	6.2:1	0.10mm-120m	62	5	BNT6910
CUMGL151	190	6.2:1	0.10mm-120m	62	5	BNT6910
CUMGL151HG	190	7.4:1	0.10mm-120m	74	5	BNT6910
CUMGL151XG	190	8.1:1	0.10mm-120m	81	5	BNT6910



## CURADO MGL

- The smallest Curado model available, developed for efficient casting of smaller lures
- Lightweight Ci4+ Body
- MicroModule Gear and X-SHIP deliver extreme smooth performance with maximum winding efficiency
- MGL spool with low inertia improves casting for lightweight lures
- SVS infinity braking system controls spool speed for precision casting
- S3D Spool for reduced vibration when casting
- Powerful Cross Carbon Drag

**BEARINGS:** 8 + 1 | **HANDLE:** Double Handle with Paddles

	g	Ratio	Line	Ret	Drag	Spool
CUMGL71HGK	195	7.4:1	0.285mm-100m	74	5.5	BNT6644
CUMGL71XGK	195	8.1:1	0.285mm-100m	81	5.5	BNT6644



## CURADO

- Featuring Micromodule Gear system and the Stable Spool design
- SVS infinity braking system controls spool speed for precision casting
- Designed to fit the needs of freshwater predator fisherman but also able to withstand tough saltwater conditions
- A true allrounder to cast bigger lures and fight big fish. It will fit perfectly for pike and big blackbass fishing with medium sized lures

**BEARINGS:** 6 + 1 | **HANDLE:** Double Handle with Paddles

	g	Ratio	Line	Ret	Drag	Spool
CU200K	215	6.2:1	0.20mm-225m	66	5	BNT5675
CU201K	215	6.2:1	0.20mm-225m	66	5	BNT5675
CU201PGK	220	5.0:1	0.20mm-225m	53	5	BNT5675
CU201HGK	215	7.4:1	0.20mm-225m	79	5	BNT5675



71HG



## SLX MGL

- The latest version of the hugely popular SLX range
- HAGANE Body for lightweight strength
- MGL spool with low inertia improves casting for lightweight lures
- SVS infinity braking system controls spool speed for precision casting
- S3D Spool for reduced vibration when casting
- Level wind for trouble free line lay
- Two different speed options to suit all preferences - fast 7.2:1 and extra fast 8.2:1

**BEARINGS:** 4 + 1 | **HANDLE:** Double Handle with Paddles

	g	Ratio	Line Capacity	Spool	Brake	Drag
SLXMGL70	200	6.3:1	0.285mm-100m	63	5.5	BNT6690
SLXMGL71HG	200	7.2:1	0.285mm-100m	72	5.5	BNT6690
SLXMGL71XG	200	8.2:1	0.285mm-100m	82	5.5	BNT6690



201HG



## GRAPPLER BB

- Lightweight Ci4+ body
- Perfect for light jigging
- Weighs only 185g for reduced fatigue and increased jig control
- SVS braking system for advanced casting control
- Long crank (51mm) power handle

**BEARINGS:** 4 + 1 | **HANDLE:** Double Handle with Paddles

	g	Ratio	Line Capacity	Spool	Brake	Drag
16GRAPBB201HG	185	7.2:1	0.20mm-225m	77	5.5	03566-0075



151HG



## SLX XT

- Mid-entry price level reel perfect for all-round fishing
- Lightweight, compact, aluminium HAGANE Body
- Long handle 45/48mm for extra control
- S3D Spool for reduced vibration when casting
- Level wind for trouble free line lay
- SVS Infinity brake control, with external adjustment dial

**BEARINGS:** 4 + 1 | **HANDLE:** Double Handle with Paddles

	g	Ratio	Line Capacity	Spool	Brake	Drag
SLXXT150	205	6.3:1	0.25mm-150m	63	5.5	BNT5959
SLXXT151	205	6.3:1	0.25mm-150m	63	5.5	BNT5959
SLXXT151HG	205	7.2:1	0.25mm-150m	72	5	BNT5959
SLXXT151XG	205	8.2:1	0.25mm-150m	82	5	BNT5959

# LOW PROFILE BAITCASTING REELS - VBS



300A



## TRANX

- Suitable for freshwater or saltwater use
- Perfect for casting big baits and catching big fish
- Max drag power over 10kg!
- CoreProtect provides long lasting durability in the harshest environments
- S3D Spool with for ultra light rotation and reduced vibration

**BEARINGS:** 5 + 1 | **HANDLE:** Double Handle with Paddles (301A, 401A), Single Handle with big knob (301HGA)

	g	Ratio	Spool	Drag	Shim	Seal
TRX300A	330	5.8:1	0.30mm-235m	75	10	BNT5522
TRX301A	330	5.8:1	0.30mm-235m	75	10	BNT5522
TRX301HGA	330	7.6:1	0.30mm-235m	100	8	BNT5522
TRX400A	340	5.8:1	0.30mm-270m	75	10	BNT5619
TRX401A	340	5.8:1	0.30mm-270m	75	10	BNT5619



301HG



## CURADO

- 300 size is the largest Curado model available and has been developed to handle the biggest freshwater fish
- Lightweight aluminium HAGANE Body for strength
- X-SHIP gearing for efficient power transfer
- VBS braking system for precise casting control
- Powerful Cross Carbon Drag to control large fish
- Level wind for trouble free line lay
- S3D Spool with for ultra light rotation and reduced vibration

**BEARINGS:** 5 + 1 | **HANDLE:** Double Handle with Paddles

	g	Ratio	Spool	Drag	Shim	Seal
CU300K	300	4.7:1	0.30mm-235m	63	10	BNT6708
CU301K	300	4.7:1	0.30mm-235m	63	10	BNT6708
CU301HGK	305	6.6:1	0.30mm-235m	88	8	BNT6708



151HG



## SLX

- Excellent combination of quality and cost, with lightweight aluminium HAGANE Body
- Long handle 45/48mm for extra control
- S3D Spool for reduced vibration when casting
- Level wind for trouble free line lay
- Available is three gear ratios (including extra fast 8.2:1) to suit personal preference

**BEARINGS:** 3 + 1 | **HANDLE:** Double Handle with Paddles

	g	Ratio	Spool	Drag	Shim	Seal
SLX150	195	6.3:1	0.25mm-150m	63	5	BNT5959
SLX151	195	6.3:1	0.25mm-150m	63	5	BNT5959
SLX151HG	195	7.2:1	0.25mm-150m	72	5	BNT5959
SLX151XG	195	8.2:1	0.25mm-150m	82	5	BNT5959



151HG



200PG

## CAIUS

- Entry level baitcasting reel, perfect for anglers who are new to baitcasting reels
- XT-7 high strength resin body
- Level wind for trouble free line lay
- Maximum drag setting 5kg to overcome the largest freshwater predators
- Lightweight aluminium spool

**SIZE:** 151

**BEARINGS:** 3 + 1

**HANDLE:** Double Handle with Paddles



CIS151HGB

210	7.2:1	10mm-120m	76	5	BNT5412

## GENPU XT

- Developed for a wide variety of boat fishing applications such as Tai rubber (Engetsu) jigging and light jigging
- Strong, lightweight XT-7 composite body
- Shielded AR-B bearings for trouble free performance
- Level wind for precise line lay
- Power handle and Ci4+ grip for angler comfort and control
- Unrivalled value for money
- Not suitable for casting

**SIZES:** 200, 201

**BEARINGS:** 3 + 1

**HANDLE:** Single Power Handle with Ci4+ round knob



GNPX200PG  
GNPX201PG

195	5.5:1	0.25mm-185m	59	5.5	04195-0079
195	5.5:1	0.25mm-185m	59	5.5	04195-0079

# FLAGSHIP MODEL

## CALCUTTA CONQUEST

- MicroModule gearing, in combination with X-SHIP, 12 ball bearings and a roller bearing delivers remarkable smoothness and positive control
- SVS breaking system for accurate casting control
- Fitted with Exciting Drag Sound system which sounds fantastic and is useful when trolling
- Synchronized level wind prevents 'bedding in' of braid on the spool for smoother casting
- Ideal for medium to extra large lure fishing and also lightweight trolling
- Saltwater proof

**SIZES:** 201, 300, 301, 400

**BEARINGS:** 12 + 1

**HANDLE:** Double Handle with Paddles



	9	12	13	14	15	16
CTCNQ201A	235	4.8:1	0.25mm-255m	57	6	BNT6862
CTCNQ300A	330	6.2:1	0.25mm-285m	84	7	BNT6029
CTCNQ301A	330	6.2:1	0.25mm-285m	84	7	BNT6029
CTCNQ400A	340	6.2:1	0.30mm-235m	84	7	BNT6050



301A

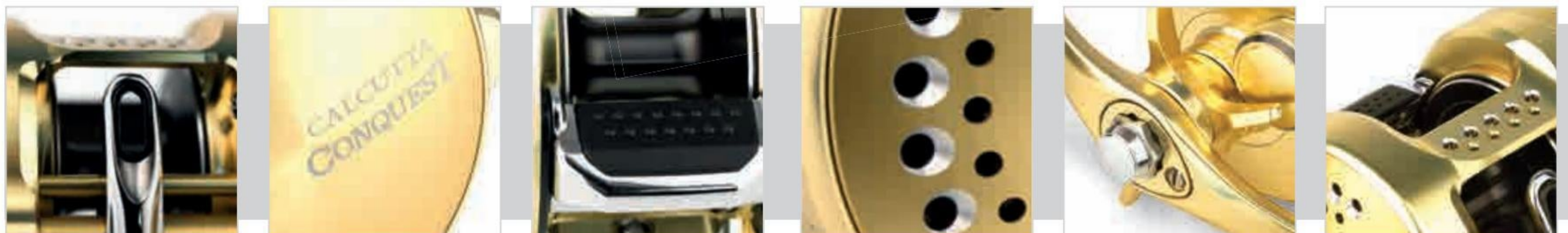





151HG



401

## CARDIFF

- An easy-to-use left hand multiplier
- Ideal for freshwater trolling or casting medium to heavy lures
- Complete casting control is achieved thanks to SHIMANO's Variable Brake System (VBS)
- Level-wind system distributes line evenly across the spool
- Die-cast aluminium frame and machined aluminium spool offer exceptional strength
- 5.8:1 gear ratio and 4 A-RB bearings make the reel suited to fishing lures that require a high speed retrieve

**SIZES:** 201, 301, 401

**BEARINGS:** 4 + 1

**HANDLE:** Double Handle with Paddles



CDF201A	230	5.8:1	0.25mm-255m	61	5	BNT3303
CDF301A	252	5.8:1	0.30mm-235m	61	5	BNT3318
CDF401A	337	5.2:1	0.35mm-270m	56	5	BNT3102

## CORVALUS

- An easy-to-use left-hand multiplier with built in level-wind
- Ideal for freshwater trolling or casting medium to heavy lures
- Fully adjustable Variable Brake System (VBS) keeps overruns to a minimum
- Ergonomic thumb bar spool release allows instant casting to moving targets

**SIZE:** 401

**BEARINGS:** 3 + 1

**HANDLE:** Double Handle with Paddles



CVL401						
	335	5.2:1	0.35mm-270m	56	5	BNT3195



# SALTWATER REELS

Saltwater fishing can be extremely severe and saltwater intrusion into the inside of a reel can cause serious performance problems. Therefore it is imperative to enhance water resistance without impairing the properties of spinning reels designed for saltwater fishing.

SHIMANO achieves this by using X-Shield for body protection and X-Protect for rotor protection. Also, the pressure put on the gearing during extreme use can create problems with wear and even failure. The use of SHIMANO's HAGANE gearing ensures that maximum performance is maintained at all times.

These technologies can be found on many of SHIMANO's latest models.





84	SALTWATER REEL TECHNOLOGY	
85	STELLA SW	
88	TWINPOWER SW	
89	SARAGOSA SW	
90	SPHEROS SW-A	<b>NEW</b>
91	SPHEROS SW	
	SOCORRO SW	



# SALTWATER REEL TECHNOLOGY



## INFINITYDRIVE

InfinityDrive has been introduced to complement the existing X-SHIP system to deliver light and powerful winding. In spinning reels this development reduces the friction of spool oscillation with a special design and combination of parts. As a result, handle rotation resistance is reduced considerably, when compared to a conventional system, resulting in easier winding, even under extreme pressure.

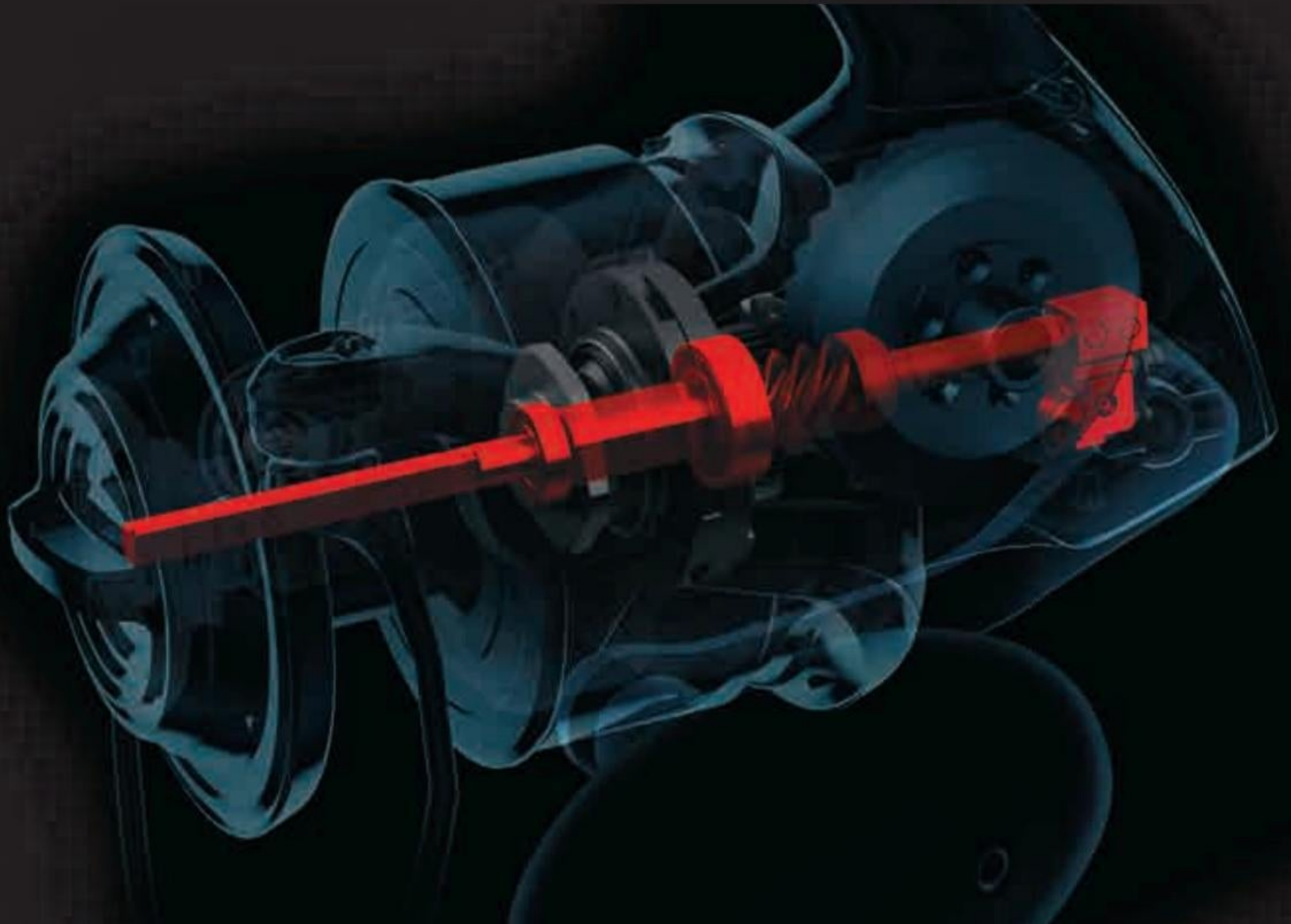

### BENEFIT

InfinityDrive enables light, but extremely powerful winding, which helps to fight powerful fish in an extreme salt water environment.

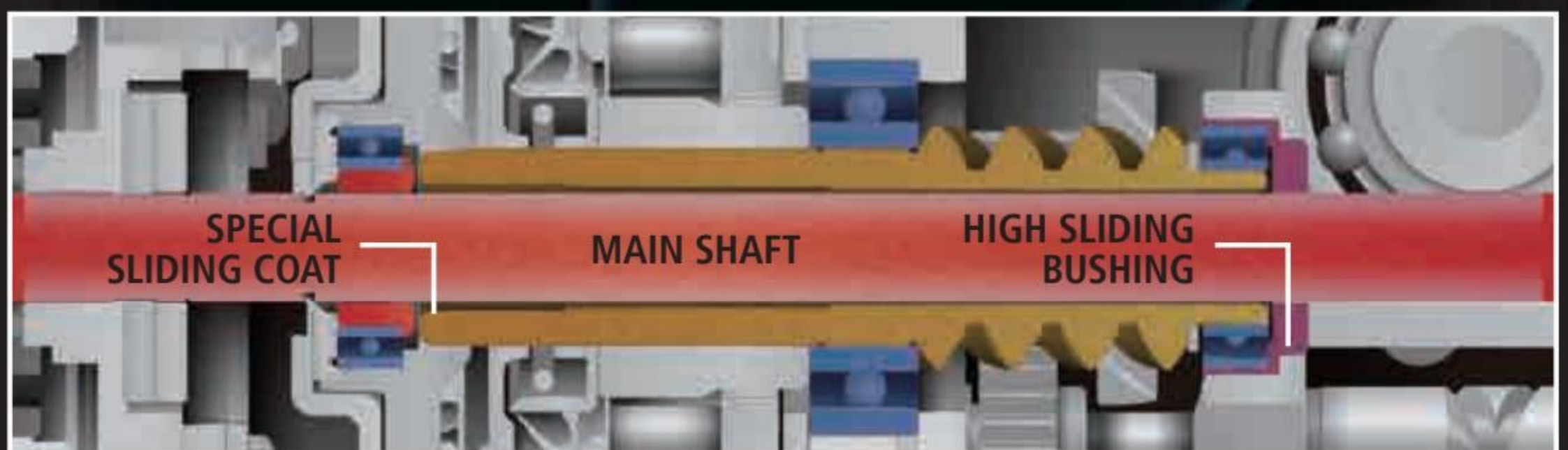

## HEAT SINK DRAG

Heat Sink technology enables dissipation of excessive heat build-up when the spool is rotating quickly and keeps the heat away from the spool surface and drag washer where it can cause a reduction in drag performance.

### BENEFIT

When playing fish under extreme pressure, it is quite common for the drag pressure to reduce in resistance as heat builds up in the spool and drag system due to friction. The Heat Sink technology dissipates heat away from important areas and enables maximum drag performance to be maintained for longer. An additional advantage is it also keeps heat away from your line reducing potential damage.

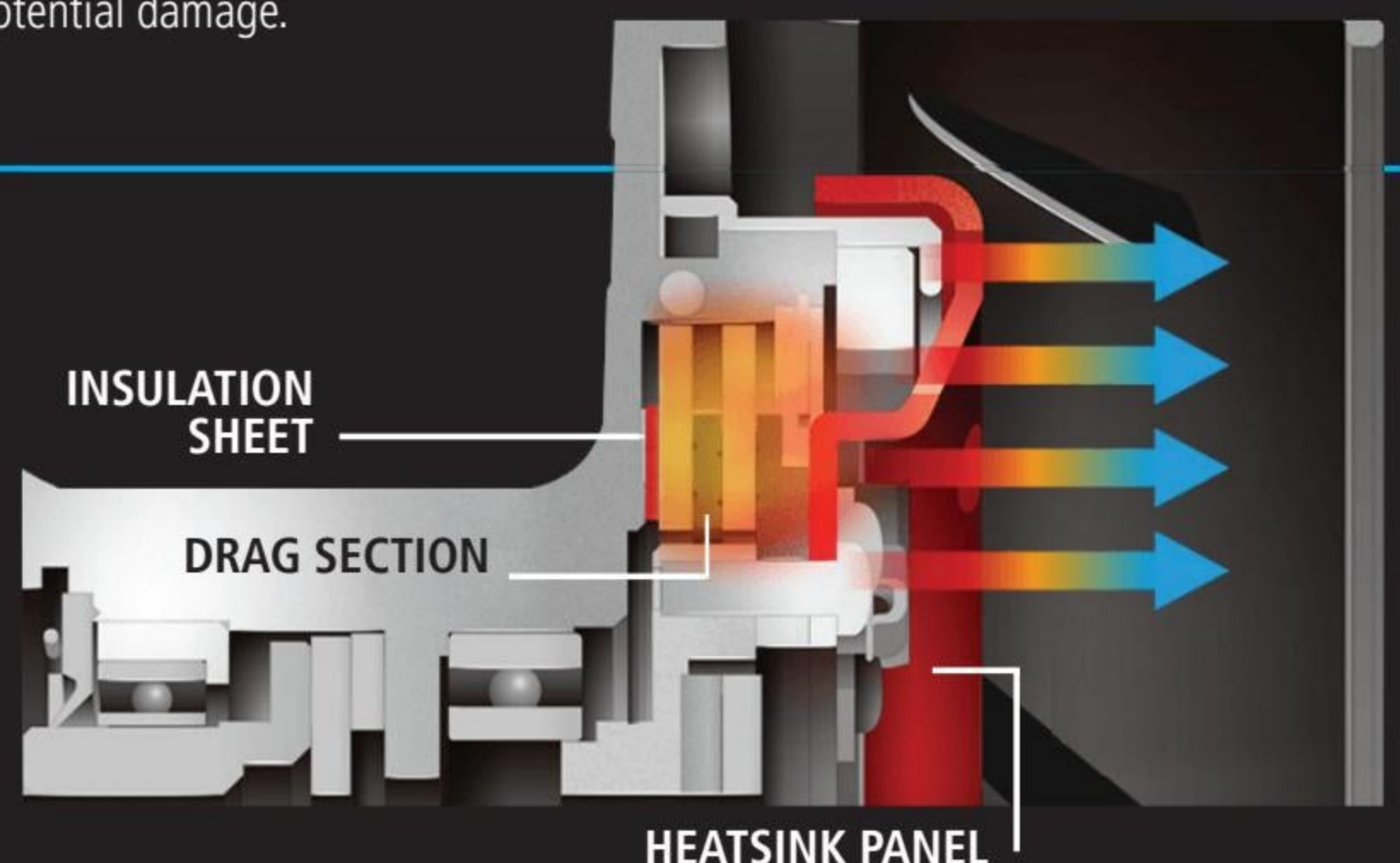



### X-SHIELD

By placing sealing gaskets in critical locations throughout the reel body, SHIMANO is able to create a water resistant structure that can hold up against the toughest conditions, giving excellent protection from water and foreign object ingress.



#### BENEFIT

Because of the X-Shield water resistant sealing, the reel is protected against water, dirt, salt and dust. That's really important, because water and foreign objects can affect the functioning of the gearing and other mechanical parts of the reel. X-Shield also increases the life-time and durability of the reel and ensures excellent longevity of performance.



### X-PROTECT

X-Protect is a water-resistant technology that comes in several forms and is dependent on the reel category and intended usage of each reel.

The roller clutch (body area) in large spinning reels works with a "contact style" water resistance.

Contact style makes use of a combination of labyrinth construction, rubber gaskets and grease to strongly prevent water from coming into a certain area of the reel. This design makes it possible to achieve up to IPX8 level water resistance for the roller clutch of some larger spinning reels.

The roller clutch in smaller reels works with a "non-contact style" water resistance. Non-contact style makes use of a labyrinth structure along with a water repellent material that ensures both light rotation and water resistance performance. Compared to larger reels, smaller reels require sensitivity and a sufficient level of water resistance. The non-contact style protects the reel but does not sacrifice rotation lightness.

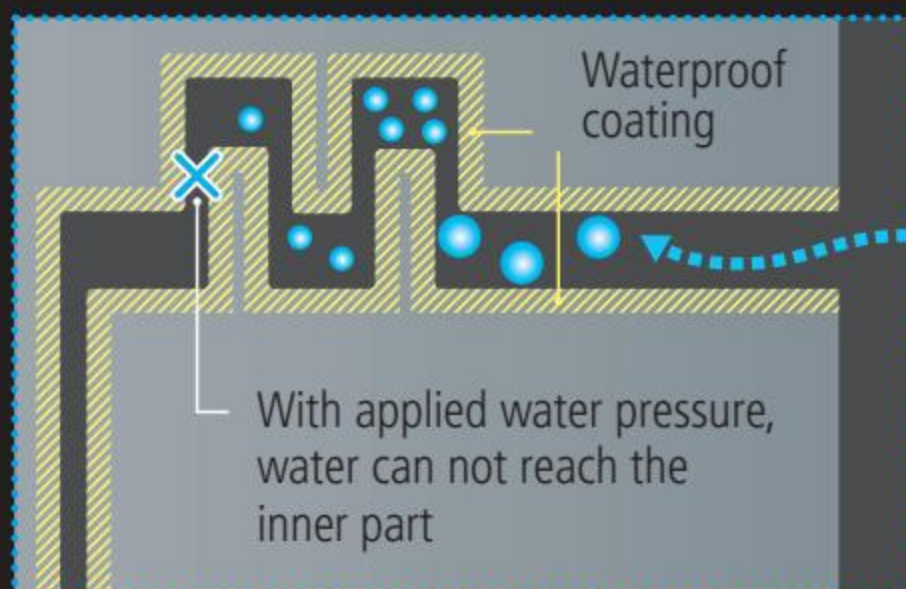

#### BENEFIT

X-Protect seals the roller clutch, line roller and drag area, to prevent water intrusion. This advanced protection technology increases the durability of the reel and gives a high level protection in even the toughest conditions. This ensures good performance for a long time, without affecting the smoothness of the reel when rotating.

### X-TOUGH DRAG

X-Tough Drag is SHIMANO's toughest drag configuration and incorporates large diameter drag washers at the base of the spool, which provide greater drag stability. The result is smooth and consistent drag performance throughout the fight.

#### BENEFIT

X-Tough Drag creates a more durable, smoother drag with increased stability. This results in more assured fish-playing, even in the most extreme circumstances.

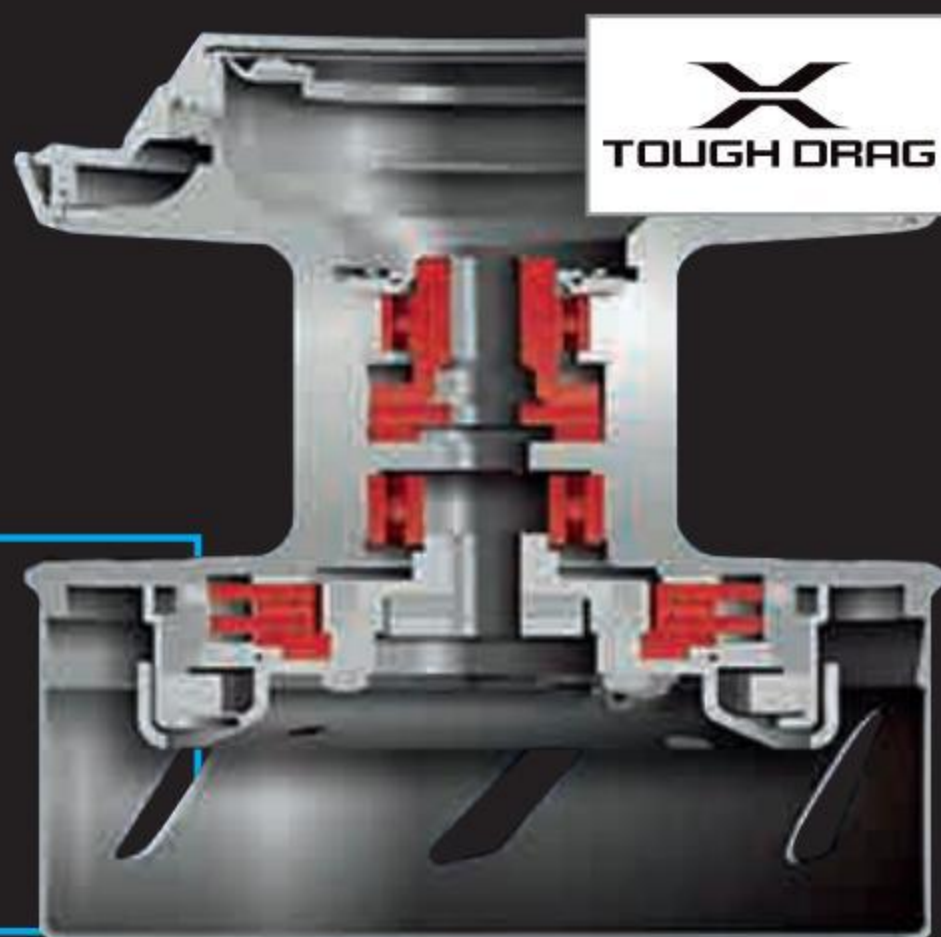

### RIGID SUPPORT DRAG

Supporting the spool with the main shaft and two bearing links in the spool reduces spool flutter to provide stable and smooth drag performance, especially in the initial stage of the fight.

#### BENEFIT

Rigid Support Drag eliminates spool movement and wobble, even at light drag settings. The result is an incredibly smooth drag even at extremely light settings.

## MAXIMUM DRAG FORCE (KG)

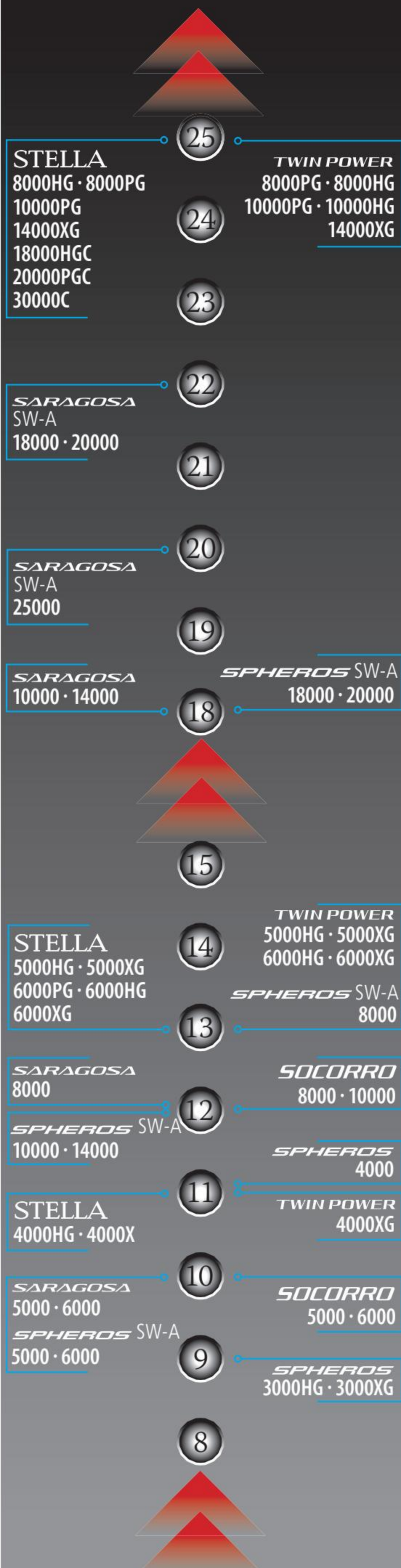

# INFINITE POWER

## STELLA SW

- The ultimate saltwater spinning reel with a worldwide reputation for excellence beyond comparison
- HAGANE Gear and Body for maximum strength and durability
- InfinityDrive increases winding torque by up to 26% providing increased smoothness and light rotation whilst also increasing power
- Improved X-Protect and X-Shield for ultimate saltwater protection
- SilentDrive, re-engineered components reduce microscopic movement in the handle resulting in quieter operation
- X-Tough Drag is an upgraded drag providing more power and adjustment control
- Heat Sink spool technology (10000 + models only) controls heat created by the drag under extreme speed to help maintain original drag setting and also reduces line damage due to excessive heat
- 8000 size has new offset handle for more power and narrow rotor for 23% reduction in rotational inertia
- Aero Wrap and AR-C spool for maximum casting performance

**SIZES:** 4000, 5000, 6000, 8000, 10000, 14000, 18000, 20000, 30000

**BEARINGS:** 13 + 1

**HANDLE:** Screw in Aluminium with Ci4+ Round Knob  
(10000, 14000 with Oval-Round Knob)

**WATER RESISTANT DRAG:** Yes



STLSW4000HGC	355	5.7:1	0.30mm-180m	93	11	RD20782
STLSW4000XGC	355	6.2:1	0.30mm-180m	101	11	RD20747
STLSW5000HGC	420	5.7:1	0.33mm-200m	97	13	RD20472
STLSW5000XGC	420	6.2:1	0.33mm-200m	105	13	RD20530
STLSW6000PGC	425	4.7:1	0.33mm-240m	83	13	RD20540
STLSW6000HGC	425	5.7:1	0.33mm-240m	103	13	RD20550
STLSW6000XGC	425	6.2:1	0.33mm-240m	112	13	RD20553
STLSW8000HGC	625	5.6:1	0.37mm-275m	107	25	RD19523
STLSW8000PGC	625	4.9:1	0.37mm-275m	94	25	RD19617
STLSW10000PGC	670	4.9:1	0.40mm-300m	102	25	RD19633
STLSW14000XGC	675	6.2:1	0.40mm-330m	134	25	RD19668
STLSW18000HGC	875	5.7:1	0.52mm-310m	129	25	RD20787
STLSW20000PGC	885	4.4:1	0.52mm-350m	104	25	RD20803
STLSW30000C	975	4.4:1	0.62mm-400m	131	25	RD20977



14000XGC

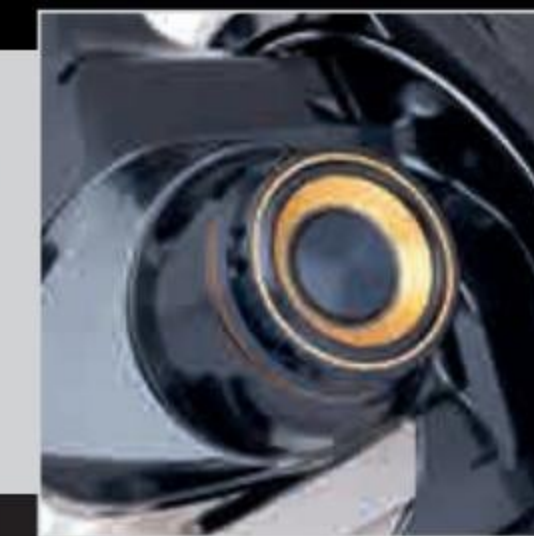

# CHALLENGE THE IMPOSSIBLE

## TWIN POWER SW

- The new TWINPOWER SW takes 30 years of SHIMANO Big Game knowledge and experience, combines it with unrivalled engineering and delivers it in one amazing reel
- HAGANE Body, HAGANE Gear, X-SHIP and SilentDrive refinement for faultless performance in extreme situations
- InfinityDrive increases smoothness and light rotation whilst also increasing winding power
- X-Shield and X-Protect technology to prevent water intrusion into the body and moving parts
- Heat Sink Drag (10,000 & 14,000) controls heat created by the drag under extreme speed to help maintain original drag setting and also reduces line damage due to excessive heat

**SIZES:** 4000, 5000, 6000, 8000, 10000, 14000

**BEARINGS:** 9 + 1 (4000 model) 10 + 1

**HANDLE:** Screw in Single Aluminium Round Knob  
(10000, 14000 with Oval-Round Knob)

**WATER RESISTANT DRAG:** Yes



	9	10	11	12	13	14
TPSW4000XGC	350	6.2:1	0.30mm-180m	101	11	RD21590
TPSW5000HGC	415	5.7:1	0.33mm-200m	97	13	RD21591
TPSW5000XGC	415	6.2:1	0.33mm-200m	105	13	RD21592
5SF41M061 (6000PG)	420	4.6:1	0.33mm-240m	83	13	-
TPSW6000HGC	420	5.7:1	0.33mm-240m	103	13	RD21594
TPSW6000XGC	420	6.2:1	0.33mm-240m	112	13	RD21595
TPSW8000PGC	615	4.9:1	0.37mm-275m	94	25	RD21511
TPSW8000HGC	615	5.6:1	0.37mm-275m	107	25	RD21478
TPSW10000PGC	655	4.9:1	0.40mm-300m	102	25	RD21518
TPSW10000HGC	655	5.6:1	0.40mm-300m	116	25	RD21529
TPSW14000XGC	660	6.2:1	0.40mm-330m	134	25	RD21532



4000XGC





# TAKES SOME BEATING

## SARAGOSA SW

- Mid priced high performance saltwater spinning and jigging reel
- HAGANE Body, HAGANE Gear and X-SHIP, combined with InfinityDrive for extreme cranking performance
- X-Protect (IPX-8 rating) for water protection and long-life durability
- Heavy duty cold forged spool with AR-C technology
- Compact models (5000 - 6000) for shore and lighter boat casting and jigging
- Mid-sized models (8000 - 14000) for shore and medium/heavy boat casting and jigging

**SIZES:** 5000, 6000, 8000, 10000, 14000, 18000, 20000, 25000

**BEARINGS:** 5 + 1

**HANDLE:** Screw in Single Aluminium

**WATER RESISTANT DRAG:** Yes (X-Shield)



	g	Ratio	Line	Ret	Spool	Part No.
SRG5000SWAXG	450	6.2:1	0.33mm-200m	105	10	RD21046
SRG6000SWAHG	455	5.7:1	0.33mm-240m	103	10	RD21091
SRG8000SWAHG	675	5.6:1	0.37mm-275m	107	12	RD21287
SRG10000SWAPG	685	4.9:1	0.40mm-300m	94	15	RD21320
SRG14000SWAXG	710	6.2:1	0.40mm-330m	135	15	RD21325
SRG18000SWAHG	915	5.7:1	0.52mm-310m	129	22	RD21389
SRG20000SWAPG	945	4.4:1	0.62mm-240m	104	20	RD21330
SRG25000SWA	970	4.4:1	0.52mm-400m	103	20	RD21387



# ALWAYS SPINNING

NEW

## SPHEROS SW

- Fantastic value, full specification saltwater spinning reel
- HAGANE Body, HAGANE Gear and X-SHIP for maximum power and strength
- Hi-speed retrieve in smaller sizes for efficient fishing of spinning techniques
- Hi-power retrieve in larger sizes for playing big game species
- X Protect water resistance for protection and light rotation feel
- InfinityDrive increases smoothness and light rotation whilst also increasing winding power
- Aero Wrap line lay and AR-C spool for improved casting

**SIZES:** 5000, 6000, 8000, 10000, 14000, 18000, 20000

**BEARINGS:** 4 + 1

**HANDLE:** Screw in Single Aluminium

**WATER RESISTANT DRAG:** Yes



10000PG

	g	Ratio	Line	Ret	Sp	RD
SPSW5000XGA	445	6.2:1	0.33mm-200m	105	10	RD21717
SPSW6000HGA	450	5.7:1	0.33mm-240m	103	10	RD21720
51SF53M061A (6000PG)	450	4.6:1	0.33mm-240m	83	10	-
SPSW8000HGA	665	5.6:1	0.37mm-275m	107	13	RD21723
SPSW10000PGA	675	4.9:1	0.40mm-300m	102	12	RD21737
SPSW14000XGA	680	6.2:1	0.40mm-300m	134	12	RD21739
SPSW18000HGA	920	5.7:1	0.52mm-310m	129	18	RD21744
SPSW20000PGA	930	4.4:1	0.52mm-310m	104	18	RD21760





4000XG

## SPHEROS SW

- HAGANE Body, HAGANE Gear and X-SHIP for maximum power and strength
- Small compact size for lighter weight rod and reel set-ups whilst retaining immense power
- Hi-speed retrieve for efficient fishing of spinning techniques
- Coreprotect water resistance for protection and light rotation feel
- Aero Wrap line lay and AR-C spool for improved casting

**SIZES:** 3000, 4000

**BEARINGS:** 3 + 1

**HANDLE:** Screw in Aluminium

**WATERPROOF DRAG:** Yes



	g	Ratio	Line	Retr	Sh	RD
SPC3000HGSW	245	6.0:1	0.25mm-210m	88	9	RD20362
SP3000XGSW	255	6.2:1	0.25mm-210m	91	9	RD20380
SP4000XGSW	280	6.2:1	0.30mm-180m	99	11	RD20389



## SOCORRO SW

- Mid-sized saltwater reel offering great value for money
- HAGANE Gear and X-SHIP for maximum winding power and efficiency
- Water resistant Cross Carbon Drag for assured performance
- Cold forged AR-C spool for long range accurate casting

**SIZES:** 5000, 6000, 8000, 10000

**BEARINGS:** 4 + 1

**HANDLE:** Zinc Diecast

**WATERPROOF DRAG:** Yes



	g	Ratio	Line	Retr	Sh	RD
SOC5000SW	440	4.6:1	0.37mm/150m	78	10	RD17411
SOC6000SW	445	4.6:1	0.37mm/190m	83	10	RD17430
SOC8000SW	640	4.9:1	0.40mm/230m	94	12	RD17433
SOC10000SW	665	4.9:1	0.40mm/300m	102	12	RD17454



## MULTIPLIER REELS

SHIMANO multiplier reels have a reputation throughout the World for innovation and reliability and are trusted by anglers of all types, from Big Game professional anglers fishing for huge marlin, tuna and sharks to freshwater predator anglers fishing for large pike and catfish. Built without compromise, SHIMANO multipliers are available in both lever drag and star drag options.





**LEVER DRAG**

- 94 TIAGRA
- 95 TALICA · TALICA II
- TYRNOS · TYRNOS II
- TLD · TLD II
- 96 SPEEDMASTER LD II
- 97 TR CHARTER SPECIAL
- TR200

**STAR DRAG**

- 98 OCEA JIGGER F CUSTOM
- OCEA CONQUEST
- OCEA JIGGER
- 99 TORIUM
- TEKOTA

**ELECTRIC**

- 100 ELECTRIC REEL TECHNOLOGY
- 101 BEASTMASTER 9000
- 102 FORCEMASTER 9000
- 103 PLAYS 4000
- PLAYS 600

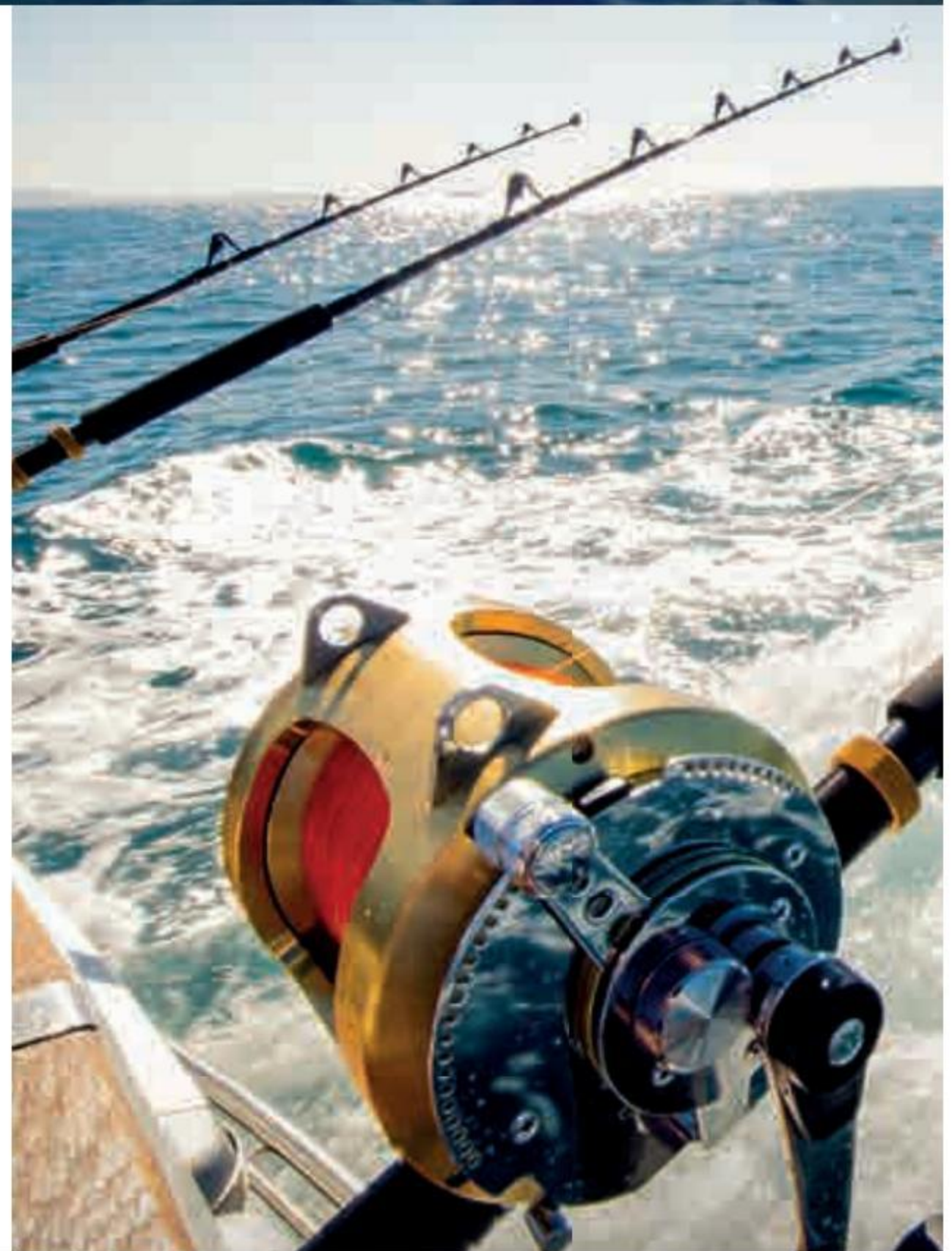

# MARKET LEADER

## TIAGRA

- Worldwide market leader in Big Game Reels
- HAGANE Body for ultimate strength
- Cold Forged Aluminium spool
- 2-Speed gearing
- Twin disk drag system (Hydrothermal Drag on 50WLRs & 80W versions)

**SIZES:** 30, 50, 80, 130

**BEARINGS:** 4

**HANDLE:** Single Steel Power Handle

**WATERPROOF DRAG:** Yes



12

TI30A	1486	3.9:1/1:1.7	50lb-385m	104/46	15	TT0694		
TI30WLRSA	1576	3.9:1/1:1.7	50lb-520m	104/46	15	TT0699		
TI50WLRSA	2447	3.1:1/1:1.3	80lb-500m	94/38	20	TT0725		
TI80WA	3266	2.5:1/1:1.3	80lb-870m	94/48	24	TT0733		
TI130A	4936	2.1:1/1:1.1	130lb-914m	99/56	40	TT0751		



8



## TALICA / TALICA II

- HAGANE Body for ultimate strength
- E.I. anti-corrosion surface treatment for saltwater resistance
- 2 speed and Single speed versions available

**BEARINGS: 6 | HANDLE:** Single Steel Power Handle

TAC8	450	6.2:1	20lb-200m	97	9	TGT1529
TAC12	655	5.7:1	25lb-255m	104	18	TGT1586
TAC16	669	5.7:1	30lb-275m	104	18	TGT1602
TAC16II	750	5.7:1/3,1:1	30lb-275m	104/56	20	TGT1602
TAC20IICAM	920	5.2:1/3,1:1	40lb/290m	104/56	20	TGT1720
TAC25IICAM	950	5.2:1/3,1:1	50lb-235m	104/56	20	TGT1727
TAC50IIGR	1588	3.8:1/1.7:1	50lb-640m	114/53	27	TGT1958

30



## TYRNOS TYRNOS II

- A powerful lever drag multiplier
- Larger sized reels designed for very large fish in deep water. Smaller models suited to Cod, Ling and Pollack but with extra strength if needed
- Aluminium frame keeps moving parts in precise alignment for increased efficiency and durability
- Features include Aluminium power handle, Duraluminium Spool, Stainless Steel Gears, Waterproof Drag and a Clicker System

**BEARINGS: 4 | HANDLE:** Single Aluminium Power Handle

TYR16	819	5.0:1	25lb-385m	115	15	TGT1164
TYR20	1021	5.0:1	30lb-410m	115	15	TGT0824
TYR30	1080	5.0:1	40lb-410m	115	15	TGT0847
TYR20II	1110	5.0:1/2.0:1	30lb-410m	115/46	15	TGT0824
TYR30II	1160	5.0:1/2.0:1	40lb-410m	115/46	15	TGT0847
TYR50IILRS	1625	4.0:1/1.5:1	50lb-640m	111/41	19	TGT1427

20 II



## TLD TLD II

- An iconic SHIMANO reel used all around the world in fresh and saltwater
- Widely regarded as being the industry standard in terms of affordable, high performance lever drag multiplier reels
- Lever drag allows for easy adjustment
- Suited to both monofilament and braid
- Ideal for targeting a wide variety of species with natural baits or artificial lures
- TLD 2 Speed reel can be switched from 4.0:1 ratio to 1.7:1 ratio with the push of a button

**BEARINGS: 4 | HANDLE:** Single Power Handle (TLD - Alu / TLD II SP Steel)

TLD15	527	4.0:1	20lb-410m	76	10	TLD0201
TLD20	670	3.6:1	30lb-410m	81	10	TLD0174
TLD25	695	3.6:1	30lb-550m	81	10	TLD0177
TLD30IIA	1064	4.0:1/1.7:1	30lb-550m	94/41	15	TT0790
TLD50IIA	1624	3.5:1/1.4:1	50lb-640m	97/38	17	TT0381

# EASY HANDLING

## *SpeedMaster* LD II

- Durable and castable 2-speed lever drag reel designed for stand up fishing
- Aluminium HAGANE Body in S Compact Body design for strength and easy handling
- Loud clicker system making it perfect for live bait fishing
- 2-Speed operation for versatility
- Accessory Drag cam lever available to make drag adjustment

**SIZES:** 12, 16, 20, 25

**BEARINGS:** 4

**HANDLE:** Single Aluminium Egg Shape

**WATERPROOF DRAG:** Yes



12II



SPM12II	730	5.7:1/3.1:1	20lb-320m	107/58	18	TGT2588
SPM16II	750	5.7:1/3.1:1	20lb-400m	107/58	18	TGT2536
SPM20II	980	5.2:1/2.3:1	30lb-430m	131/58	20	TGT2783
SPM25II	1025	5.2:1/2.3:1	40lb-385m	131/58	20	TGT2770







2000LD



200G

## Charter Special

- Quite possibly the most versatile, affordable multiplier reels available and a firm favourite with professional charter skippers
- Unique combination of a smooth lever drag, level wind and a centrifugal braking system
- Rigid, corrosion free graphite frame proves extremely robust
- Suited to both monofilament and braid
- Completed with a Stainless Steel gear, waterproof drag and clicker system

**SIZES:** 1000, 2000

**BEARINGS:** 4

**HANDLE:** Single Aluminium Power Handle

**WATERPROOF DRAG:** Yes



TR1000LD	465	5.2:1	14lb-300m	66	15	TGT0110
TR2000LD	485	5.2:1	14lb-440m	66	15	TGT0118

## TR

- The perfect star drag multiplier reel for the novice angler
- Level wind ensures perfect distribution of line across the spool
- Clicker System to indicate bites when set on freespool
- Single steel power handle provides immense winding power
- Stainless Steel gear for high strength and durability

**SIZES:** 200

**BEARINGS:** 1

**HANDLE:** Single Steel Power Handle



TR200G	374	4.3:1	17lb-365m	64	6	TGT0075
--------	-----	-------	-----------	----	---	---------

# STAR DRAG REELS



2000NR



## OCEA JIGGER F CUSTOM

- Featuring a 'FALL' lever to control the speed of a falling jig with greater precision from total free-fall to ultra-slow
- HAGANE Body for maximum strength under pressure
- Micromodule gear with 8 Shielded A-RB bearings plus roller bearing
- Waterproof carbon drag with SHIMANO Exciting Drag Sound
- X-Protect prevents water intrusion without increasing winding resistance
- Salt resistant EI protection

**BEARINGS:** 8 + 1 | **HANDLE:** Single Power Handle

	g	Ratio	Line	Ret	Spool	Part No.
OCEAJGFC1500HG	430	6.4:1	0.33mm-210m	98	7	04002-0080
OCEAJGFC1501HG	430	6.4:1	0.33mm-210m	98	7	04003-0175
OCEAJGFC2000NR	605	6.2:1	0.33mm-300m	117	10	04004-0083
OCEAJGFC2001NR	605	6.2:1	0.33mm-300m	117	10	04005-0174



300PG



## OCEA CONQUEST

- HAGANE Body combined with MicroModule gearing and X-SHIP for durable, super smooth performance
- Advanced Cross Carbon Drag plus Exciting Drag Sound system
- Level Wind system prevents 'bedding in' of braid on the spool for smoother casting
- S Compact Body for easy handling with lighter rods
- SVS and Super Free Spool casting control on smaller 201 model
- **BEARINGS:** 12 + 1 (201) 10 + 1 (301)

	g	Ratio	Line	Ret	Spool	Part No.
OCCNQ201PG	275	4.8:1	PE2-200m	60	6	03300-0094
OCCNQ301HG	345	6.2:1	PE3-200m	84	7	03402-0118
OCCNQ301PG	340	4.8:1	PE3-200m	65	8	03402-0118



2000HG



## OCEA JIGGER

- Designed with narrow, deep spool especially for deep water jiggling
- HAGANE Body for maximum strength under pressure
- Micromodule gear with 8 Shielded A-RB bearings plus roller bearing
- Waterproof carbon drag with SHIMANO Exciting Drag Sound
- X-Protect prevents water intrusion without increasing winding resistance
- Salt resistant EI protection
- Handle length can be adjusted from 73mm to 85mm for additional cranking power

**BEARINGS:** 8 + 1 | **HANDLE:** Single Power Handle

	g	Ratio	Line	Ret	Spool	Part No.
5RL02211H	595	6.2:1	0.33mm-300m	117	10	03672-0171
5RL02211P	595	5.1:1	0.33mm-300m	96	10	03674-0171



20HGA



500HG

## TORIUM

- S Compact aluminum body for easy handling and tough conditions
- Brass gears with high speed 6.2:1 retrieve - 117cm of line per handle turn
- Cross carbon drag washers for smooth operation up to 11kg maximum drag
- Cold forged aluminium spool
- Micro adjustable drag system

**SIZES:** 14, 16, 20

**BEARINGS:** 3 + 1

**HANDLE:** Single Cold Forged Aluminium Handle



TOR14HGA	425	6.3:1	14lb-275m	97	15	TGT2238
TOR16HGA	535	6.2:1	16lb-410m	117	11	TGT2084
TOR20HGA	545	6.2:1	20lb-385m	117	11	TGT2093
<b>LEFT-HAND MODELS</b>						
TOR16HGAL	535	6.2:1	16lb-410m	117	11	TGT2084
TOR20HGAL	545	6.2:1	20lb-385m	117	11	TGT2093

## TEKOTA

- S Compact HAGANE Body for extreme strength
- Level wind added to ensure excellent line lay
- Easily adjustable and reliable Star Drag
- Available with a line counter option for targeting fish feeding at specific depths
- Brass gear for high strength and durability
- LC is line counter in feet. LCM is line counter in meter

**SIZES:** 301, 401, 500, 501, 600, 601

**BEARINGS:** 3 + 1

**HANDLE:** Single Cold Forged Aluminium Handle



TEK301HGLCA	340	6.6:1	12lb-215m	89	9	TGT2601
TEK401HGLCA	370	6.6:1	12lb-300m	89	9	TGT3196
TEK500HGLCMA	430	6.3:1	12lb-400m	75	11	TGT2304
TEK501HGLCA	430	6.3:1	12lb-400m	75	11	TGT2304
TEK600HGLCMA	450	6.3:1	20lb-275m	75	11	TGT2334
TEK601HGLCA	450	6.3:1	20lb-275m	75	11	TGT2334

# ELECTRIC PERFORMANCE

**A BRUSHLESS DC MOTOR FOUND IN THE BEASTMASTER...**



**AMAZING PERFORMANCE, EVEN A RISE IN TEMPERATURE CANNOT SLOW IT DOWN!**

Inside the motor, there is a special strong magnet that can maintain its performance level even at high temperatures. The motor is specially tuned to meet the reel's specific performance target.



**THERMO ADJUST DRAG**

A control function designed to suppress abnormal heat generation of the drag to maintain stable drag performance. If the drag slips while the motor of the electric reel is on, the gear will idle and cause an abnormal heat generation in the drag area. In order to suppress this heat generation, when the drag is slipping, the motor speed is automatically reduced.

**BENEFIT**

During fights with strong fish in a salt water environment, anglers will keep full drag power and lines keep their breaking strength due the smart heat outflow.



**E-EXCITING DRAG SOUND**

e-Exciting Drag Sound is a technology which enables the angler to have a drag sound on a baitcasting or multiplier type reel.

**BENEFIT**

It works in the same way as the sound of a spinning reel when line is pulled from the drag: a 'click-click-click' or a 'swoosh' sound is heard. This is a nice feature for a lot of anglers, who like to fish with a baitcasting reel, but who are missing the sound of the drag when fighting a fish.



**FINE DOT LCD**

A liquid crystal LCD screen with high visibility and operability

**BENEFIT**

The screen of the electric reel is easy to read, even in strong sunlight, enabling accurate reading of the screen.

# AMAZING POWER

## *BeastMaster*

- Fitted with advanced, brushless motor for high speed, high torque operation
- Thermo adjust drag control suppresses heat generation and has double heat dissipation
- Exciting drag sound - when the drag is activated an electronic sound is heard, the larger the fish, the greater the sound
- LCD display screen provides all required information

**SIZES:** 9000

**BEARINGS:** 14

**HANDLE:** Single Aluminium Power Handle



**PRACTICAL POWER** 20kg  
**MAXIMUM SPEED** 165m/min

BM9000A\*

1485 3.1:1 PE8-900m 88 25 -

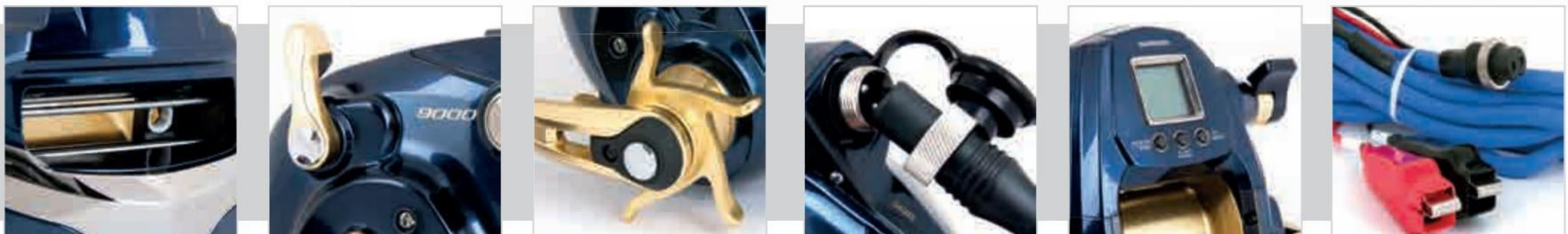

\* English user manual available and English system operation available

# ADVANCED FEATURES

## *ForceMaster* **9000**

- HAGANE Body with Heat Free System II ventilation ports for efficient heat dissipation of motor heat
- Advanced, brush motor for high speed, high torque operation
- Multi-disc drag with four carbon cross washers generating 25kg maximum drag pressure
- Exciting drag sound - when the drag is activated an electronic sound is heard, the larger the fish, the greater the sound
- Constant tension and constant speed retrieve modes
- Fine dot LCD display screen provides all required information

**SIZE:** 9000

**BEARINGS:** 3

**HANDLE:** Single Power Handle



9000A

FM9000A\*





4000

## PLAYS

- Updated electric reel with sporty and modern look
- Technical features: HAGANE body, carbon drag, heat free system
- Several reeling modes including jigging mode
- Drag force of 15kg

**SIZES:** 4000

**BEARINGS:** 2

**HANDLE:** Single Power Handle



PLAYS4000\*

1270 3.2:1 PE8-300m 68 15 TGT2264



600

## PLAYS

- Versatile mid-sized electric reel
- Ultra high quality S A-RB Bearings
- Cross Carbon Drag with Heat Free System
- LCD display screen

**SIZES:** 600

**BEARINGS:** 5

**HANDLE:** Single Power Handle



PLAYS600\*

475 5.5:1 PE3-200m 59 5 -

## SPINNING REEL MAINTENANCE TIPS



**1** Tighten drag knob and rinse under low pressure tap water in upright position



**2** Rotate spool and rinse for 15-20 seconds



**3** Use a toothbrush to brush handle area, line roller area and drag knob



**4** Spin reel in fast rotation to channel excess water out



**5** Use a dry cloth to wipe down reel exterior



**6** Use an air duster to spray difficult access area/ joints to clear off excess water



**7** Remove drag knob and wipe off excessive water on spool and rotor area



**8** Screw back drag knob and leave it in a cool dry place

- 
  - Remove line after deep sea fishing to wash down spool or if intending to keep for long time storage
  - Avoid placing your reel on boat side rod holders when boat is traveling to prevent splashes of sea water
  - Put 1-2 drops of oil on main shaft, line roller, handle knob bearings, drive gear bearings and screws after 2-3 times usage
  - Send for servicing every six months if the reel is being used frequently

- 
  - Rinse your reel when drag knob is loose
  - Remove handle when washing
  - Use high pressure water to wash down your reel
  - Wash your reel in an upside down position
  - Soak reel in a bucket of fresh water
  - Place your reel under direct sunlight after washing

## BAITCASTING REEL MAINTENANCE TIPS



**1** Tighten cast control cap and star drag before washing



**2** Rinse well under low pressure water before washing



**3** Rotate spool and rinse for 15-20 seconds



**4** Use a toothbrush to brush handle and star drag area



**5** Use a tube brush to brush reel seat and line guide to ensure salt removal



**6** Spin the reel in fast rotation to channel excess water out



**7** Use a dry cloth to wipe the exterior of the reel



**8** Remove the side cover and wipe off excessive water droplets

- 
  - Remove line after deep sea fishing to wash down spool or if intending to keep for long time storage
  - Avoid placing your reel on boat side rod holders when boat is traveling to prevent splashes of sea water
  - Put 1-2 drops of oil on main shaft, line roller, handle knob bearings, drive gear bearings and screws after 2-3 times usage
  - Send for servicing every six months if the reel is being used frequently

- 
  - Loosen cast control and star drag before washing as water might penetrate into the body
  - Rinse overhead baitcasting reel on high pressure water
  - Dip or soak your reel in fresh water
  - Place directly under sunlight after washing
  - Wash your reel in upside down position



# ELECTRIC REEL MAINTENANCE TIPS



**1** Tighten star drag and cast control cap before washing



**2** Cover socket with rubber socket cap



**3** Quick run through of low pressure water on screen (not more than 3 seconds)



**4** Rinse the spool area for removal of remaining salt



**5** Engage clutch and pull out 2-3 meter of line while running low pressure water



**6** Use a toothbrush to brush the handle shank and handle knob area



**7** Use a tube brush to brush small accessible area (reel seat, line guide area) to ensure removal of remaining salt



**8** Use a wet cloth to wipe down the whole reel to ensure remaining salt and bait is removed



**9** Use a dry cloth to wipe down completely



**10** Use an air duster to spray difficult access areas to clear off water droplets



**11** Loosen star drag and leave in a dry, cool place



- Wash your reel with warm water (under 30 degrees Celsius)
- Detergent can be used if stubborn stains cannot be removed
- Wash your reel after every trip
- Remove line after deep sea fishing to wash down spool or if intending to keep for long time storage
- Avoid placing your reel on boat side rod holders when boat is traveling to prevent splashes of sea water



- Wash the screen for too long as water might penetrate
- Wash the reel when the motor is still hot
- Use chemicals like gasoline, kerosene, benzene to wash down reel as it will damage the coating
- Wash your reel when the socket is not covered
- Wash when star drag and cast control is not tightened
- Dip or soak the whole reel into a bucket of fresh water
- Use high pressure water to wash down your electric reel
- Place your reel under direct sunlight after washing

## GEARING TECHNOLOGY

### HAGANE GEAR

The HAGANE Drive Gear is produced by SHIMANO's cold forging technology, without the need for additional machining. This results in gearing parts which retain the characteristics of the pure material, keeping it as strong as possible.

### MICROMODULE GEAR

MICROMODULE GEAR is a machined gear component, made with great precision. The super-refined teeth produce seamless engagement with other gears.

### MICROMODULE II GEAR

MICROMODULE II GEAR are super-refined gear teeth to ensure seamless gear engagement. This state-of-the-art gear tooth surface design is an evolution of the MICRO MODULE GEARING, made possible by SHIMANO's exclusive manufacturing capabilities.

### X-SHIP

X-SHIP stands for Extra Smooth & High Power. It is a precision gearing system which enables smooth yet strong reeling. By supporting the pinion gear at both ends and integrating a bigger drive gear with improved positioning, increased gearing efficiency and power is produced. It results in ultra-light handle rotation combined with excellent power efficiency.

### SILENTDRIVE

The SilentDrive technology encompasses the total redesign of the internal components to reduce microscopic handle play and eliminating noise and any unnatural feeling from the worm shaft drive. The combination of these redesigned components and extremely fine engineering tolerances produces an extremely smooth and silent reeling sensation.

### INFINITYDRIVE

InfinityDrive is a mechanism developed by SHIMANO which achieves more powerful and lighter winding. By changing the supporting pinion gear, rotational resistance is drastically reduced compared to our conventional products without reducing the gear strength.

### INFINITYXROSS NEW!

INFINITYXROSS is an advanced drive gear technology which uses wider gear teeth. The increased surface area distributes pressure more evenly across the full face of the teeth as they meet during rotation. Compared to similar sized gears, INFINITYXROSS increases durability by 100% without affecting smoothness.

### 2-SPEED GEARING

This shifting mechanism is designed so that gearing changes are quick and easy, even when fighting a fish. The low gear ratio used for high-power retrieves is selected by pushing the button on the base of the handle. Return to the high-speed ratio by sliding the release button along the handle shank.

## BODY TECHNOLOGY

### HAGANE BODY

HAGANE BODY is made out of precision machined aluminium or magnesium. These body designs create stiffness and impact resistance, while at the same time eliminating flexing of the body. The HAGANE BODY is highly rigid and protects gear rotation performance from heavy loads and shocks.

### Ci4+

A Ci4+ Body is made out of Ci4+ composite material with very special characteristics. It is stronger than the original Ci4 and XT-7 graphite, and also lighter in weight. Because Ci4+ does not contain any metal, it is not affected by corrosion, making it suitable for salt water use. Ci4+ parts are lighter and stronger than any other composite material SHIMANO uses in their products.

### CORESOLID BODY

The CoreSolid Body, which is featured on some bait casting reels, integrates the B-Side Plate, level wind guard and frame into one solid once piece construction.

### X-SHIELD

By placing sealing gaskets in critical locations throughout the reel body, SHIMANO is able to create a water resistant structure that can hold up against the toughest conditions, giving excellent protection from water and foreign object ingress.

### G FREE BODY

G Free Body technology has been developed to shift the reel's centre of gravity closer to the rod. This has been achieved by moving the oscillation mechanism more towards the top of the reel. By moving the centre of gravity closer to the angler's hand position, the G Free Body helps to reduce fatigue and enhance casting comfort.

### CORE PROTECT

Core Protect is a SHIMANO technology which is developed to keep water out of the reel, without creating a heavier rotation feeling, in two areas:

1. The Roller Clutch Bearing. This is the most critical area when comes to balancing water resistance without affecting the light and smooth rotation. A surface protection coating causes water to bead preventing water from flowing into the small crevices where it can reach the mechanism of the roller clutch bearing.
2. The Line Roller: A line roller with Core Protect has a one-piece design that provides water resistance and lowmaintenance. The sealed design does not require oil.

### X-PROTECT

X-Protect is a water-resistant technology that comes in several forms and is dependent on the reel category and intended usage of each reel. The roller clutch (body area) in large spinning reels works with a "contact style" water resistance. Contact style makes use of a combination of labyrinth construction, rubber gaskets and grease to strongly prevent water from coming into a certain area of the reel. This design makes it possible to achieve up to IPX8 level water resistance for the roller clutch of some larger spinning reels. The roller clutch in smaller reels works with a "non-contact style" water resistance. Non-contact style makes use of a labyrinth structure along with a water repellent material that ensures both light rotation and water resistance performance. Compared to larger reels, smaller reels require sensitivity and a sufficient level of water resistance. The non-contact style protects the reel but does not sacrifice rotation lightness.

### PARALLEL BODY

SHIMANO's Parallel Body technology ensures the rod and reel alignment is perfectly parallel. The axel and spool are parallel to the rod, minimising the amount of line slapping onto the blank between the spool and the first guide during the cast.

### 'S' COMPACT BODY

A 'S' Compact Body is found on baitcasting and small multiplier reels. It has an asymmetrical side plate construction where the side plate on the handle side of the reel is larger to accommodate the gears, whilst the opposite side (palming) is smaller than a conventional side plate for increased comfort and functionality.

## BAIL TECHNOLOGY

### X RIGID BAIL

The adoption of thicker titanium wire dramatically increases the rigidity and impact resistance of the bail arm. The nature of the metal (titanium) makes the bail arm lighter and provides excellent corrosion resistance.

### ONE PIECE BAIL

One Piece Bail is a bail arm made from one piece of material, which allows the line to slide very smoothly over it to the line roller. In addition, this one piece construction results in a stronger bail arm, which is much less likely to bend, or even break, under enormous pressure.

### ANTI-TWIST FIN NEW!

ANTI-TWIST FIN is an elastic and removable\* fin placed on the rotor next to the line roller. It is designed to create the perfect tension between the line and the spool and improve line management efficiency, especially when using supple, thin diameter braid and mono. \* Removing the fin is only necessary with lines over 0.47mm or with very large knots.

## DRAG TECHNOLOGY

### HI-SPEED DRAG

Hi-speed drag is SHIMANO's fastest drag system and can change the drag setting from free-spool mode to fighting mode with only a very small turn to the knob located on the front of the spool.

### EXCITING DRAG SOUND

Exciting Drag Sound is a technology which enables the angler to have a drag sound on a baitcasting or multiplier type reel.

### HEAT SINK DRAG

Heat Sink technology enables dissipation of excessive heat build-up when the spool is rotating quickly and keeps the heat away from the spool surface and drag washer where it can cause a reduction in drag performance.

### X-TOUGH DRAG

X-Tough Drag is SHIMANO's toughest drag configuration and incorporates large diameter drag washers at the base of the spool, which provide greater drag stability. The result is smooth and consistent drag performance throughout the fight.

### CROSS CARBON DRAG

Cross Carbon Drag is made out of a carbon drag washer matrix, which delivers great heat resistance and super smooth drag performance.

### X DRAG

X Drag is a drag star which is smaller than usual. This is done in order to position the reel handle closer to the body of the reel which increases cranking leverage, rigidity and torque.

## **DURACROSS DRAG NEW!**

DURACROSS DRAG is an advanced drag washer construction that combines the best characteristics and feel of felt washers, including initial hooking power, with the increased durability of cross-carbon washers.

## **RAPID FIRE DRAG**

Rapid Fire Drag is a drag system which is very precise and fast at the same time. It enables adjustment of the drag from heavy to light settings (and vice-versa) in only half a turn of the drag knob.

## **RIGID SUPPORT DRAG**

When hooking a large fish, the smoothness of the initial movement of the drag is the most important to avoid line break. By supporting the spool with the main shaft and two bearing links in the spool, it is possible to suppress the spool's flutter and to provide stable and smooth drag performance.

## **FIGHTIN' DRAG II**

The Fightin' Drag mechanism is available for some spinning reels with a rear-drag system. Just above the rear drag knob there is an adjustment lever. This lever allows the angler to adjust the drag tension during the fight in a very controlled way by moving it to the right or the left to increase or decrease the drag pressure.

## **INSTANT-DRAG**

SHIMANO Instant-Drag allows a quick adjustment of the front drag knob to take the reel from a current drag setting to free spool in just half a turn (and vice-versa).

## **THERMO ADJUST DRAG**

A control function designed to suppress abnormal heat generation of the drag to maintain stable drag performance. If the drag slips while the motor of the electric reel is on, the gear will idle and cause an abnormal heat generation in the drag area. In order to suppress this heat generation, when the drag is slipping, the motor speed is automatically reduced.

## **FRONT DRAG**

A front drag spinning reel has the drag knob located on top of the reel spool. This category is the most popular type of spinning reel.

## **REAR DRAG**

A rear drag spinning reel has the drag knob located at the back of the reel.

## **WATERPROOF DRAG**

The Water Proof Drag contains rubber gaskets which are placed to protect the drag system. It seals the drag against intrusion of the elements such as water and dust.

## **DARTANIUM DRAG**

This drag material provides a wider range of drag settings, along with very smooth drag performance.

## **LEVER DRAG**

A lever drag multiplier has a drag which can be set using a lever at the side of the reel. Lever drags are designed for big, hard fighting fish.

## **STAR DRAG**

A star drag multiplier has a drag which can be set using the star at the side of the reel. This is able to create a lot of drag tension.

## **ROTOR TECHNOLOGY**

### **MAGNUMLITE ROTOR**

The Magnumlite Rotor is an ultra-light improved rotor made out of Ci4+ material. The profile of the rotor is made asymmetrical and the bail arm mechanism, which is usually situated on the same side as the line roller, has been moved to the opposite side. Both of these changes improve the balance. The rotor rigidity at the line roller side has been improved and reduces the deflection under maximum pressure by up to 30%.

### **X RIGID ROTOR**

SHIMANO's X Rigid Rotor is an extra strong and durable rotor. The shape and thickness of the aluminium rotor creates high rigidity that results in more fish fighting power. Increased mass of the aluminium rotor generates more inertia resulting in easier fishing of heavy jigs and high resistance lures.

## **OSCILLATION TECHNOLOGY**

### **AERO WRAP**

Aero Wrap is a worm gear oscillation system with a specially designed pitch to create optimal oscillation speeds for the AR-C spool design. The one speed oscillation system provides a line-lay with one speed (the same speed upwards and downwards). The two-speed oscillation system (the spool moves upward quickly and downwards slowly) lays the line onto the spool in a precise crisscross pattern that reduces line-to-line friction when casting.

### **SLOW OSCILLATION**

With up to 35-40 wraps per cycle, this slow oscillation exceeds almost all other manufacturers' reels.

### **SUPER SLOW 5**

A minimum of 45-55 wraps per cycle. This makes almost perfect parallel spooling possible and gives a huge improvement in casting distance and precision.

### **SUPER SLOW 10**

A minimum of 95-110 wraps per cycle. This produces parallel line spooling and the best casting distance, control and precision possible.

### **INFINITYLOOP NEW!**

INFINITYLOOP is an ultra slow line oscillation designed for smaller spinning reels. The spool moves up and down very slowly as the rotor wraps line onto it, allowing the line to spool in an almost parallel configuration. This creates a smooth profile that improves line management when casting and also when playing fish.

## **HANDLES**

### **SCREW IN HANDLE**

A screw-in handle can be screwed directly into the gearing of the spinning reel. This reduces play and unwanted movement of the handle and gives a better rotational feeling.

### **X RIGID HANDLE**

The X Rigid Handle is a cold forged handle shank. The shank and shaft support parts are integrally molded to eliminate deflection. Power loss is eliminated and direct and powerful winding is realised.

## **ERGONOMIC POWER GRIP**

The handle grip, made of a comfortable, non-slip rubber, is formed to provide maximum comfort and power.

## **SPOOL TECHNOLOGY**

### **MAGNUMLITE SPOOL**

The lightweight MGL Spool features reduced spool inertia, for improved casting distance and accuracy with lighter lures.

### **LONG STROKE SPOOL**

The Long Stroke Spool design has a longer stroke, compared to conventional spool designs. This long stroke specification results in longer casting distances.

### **SILENT TUNE**

Silent Tune is an advanced SHIMANO technology. As with any casting reel, the spool rides on bearings. These bearings have pockets in the frame or side plates which house the bearings and are given some tolerance in order to make the bearings more easily changeable. While the tolerance is necessary, it allows the bearings to move slightly during casting, leading to the smallest of vibrations that take energy away from the core of the reel and reduce the distance and smoothness of the cast. Silent Tune technology adds small springs under the bearings which keep the bearings in place, ensuring proper alignment and eliminating any movement or vibration that may occur.

### **SUPER FREE SPOOL**

Super Free was designed to eliminate friction on the spool shaft during the cast. In standard baitcasting reels, when the clutch bar is pressed down, the pinion gear is freed and can drag on the spool shaft creating friction that can limit the length of a cast. With SF, the pinion gear is supported by a ball bearing so that when the clutch is disengaged in preparation for a cast, the pinion gear and spool shaft are kept in perfect alignment.

### **S3D SPOOL**

SHIMANO's S3D technology leads to significantly reduced spool vibration. By designing a balanced and uniform thin wall aluminium constructed spool, S3D creates an incredibly smooth feeling when casting and retrieving lures.

## **BALLBEARING TECHNOLOGY**

### **A-RB BEARING**

SHIMANO Anti-Rust Bearings (A-RB) have undergone a special heat treatment process resulting in high metal strength and long lasting corrosion resistance.

### **S A-RB BEARING**

These bearings have undergone a special heat treatment resulting in high metal strength. Shielded A-RB bearings use either a rubber shield or stainless steel shield (depending on bearing size) for the ultimate in corrosion resistance and contaminant protection against sand, salt or dust.

# REEL SPECIFICATIONS

MODEL	HAGANE GEAR	DRIVE GEAR	X-SHIP	HAGANE BODY	BODY MATERIAL	MGL ROTOR	X-PROTECT	SILENDRIVE	G FREE BODY	AR-C SPOOL	ONE-PIECE BAIL	WEIGHT (G)	BB QTY	LINE RETRIEVE PER CRANK(CM)	GEAR RATIO	MAX DRAG FORCE (KG)	WATER PROOF DRAG
<b>FRONT DRAG</b>																	
STELLA FK 1000	✓	MICRO MODULE II	✓	✓	MAGNESIUM		✓	✓	✓	✓	✓	170	12	64	5.1:1	3	✓
STELLA FK C2500S	✓	MICRO MODULE II	✓	✓	MAGNESIUM		✓	✓	✓	✓	✓	175	12	70	5.1:1	3	✓
STELLA FK 2500	✓	MICRO MODULE II	✓	✓	MAGNESIUM		✓	✓	✓	✓	✓	210	12	75	5.1:1	9	✓
STELLA FK2500S	✓	MICRO MODULE II	✓	✓	MAGNESIUM		✓	✓	✓	✓	✓	205	12	75	5.1:1	4	✓
STELLA FK 2500S HG	✓	MICRO MODULE II	✓	✓	MAGNESIUM		✓	✓	✓	✓	✓	205	12	86	5.8:1	4	✓
STELLA FK 2500 HG	✓	MICRO MODULE II	✓	✓	MAGNESIUM		✓	✓	✓	✓	✓	210	12	86	5.8:1	9	✓
STELLA FK C3000	✓	MICRO MODULE II	✓	✓	MAGNESIUM		✓	✓	✓	✓	✓	210	12	75	5.1:1	9	✓
STELLA FK C3000M HG	✓	MICRO MODULE II	✓	✓	MAGNESIUM		✓	✓	✓	✓	✓	210	12	86	5.8:1	9	✓
STELLA FK C3000 XG	✓	MICRO MODULE II	✓	✓	MAGNESIUM		✓	✓	✓	✓	✓	210	12	94	6.4:1	9	✓
STELLA FK 4000M	✓	MICRO MODULE II	✓	✓	MAGNESIUM		✓	✓	✓	✓	✓	260	12	87	5.3:1	11	✓
STELLA FK 4000 XG	✓	MICRO MODULE II	✓	✓	MAGNESIUM		✓	✓	✓	✓	✓	260	12	101	6.2:1	11	✓
STELLA FK C5000 XG	✓	MICRO MODULE II	✓	✓	MAGNESIUM		✓	✓	✓	✓	✓	260	12	101	6.2:1	11	✓
TWINPOWER FD 1000	✓	MICRO MODULE II	✓	✓	ALUMINIUM		✓	✓	✓	✓	✓	175	9	64	5.1:1	3	✓
TWINPOWER FD C2000S	✓	MICRO MODULE II	✓	✓	ALUMINIUM		✓	✓	✓	✓	✓	180	9	69	5.1:1	3	✓
TWINPOWER FD 2500	✓	MICRO MODULE II	✓	✓	ALUMINIUM		✓	✓	✓	✓	✓	210	9	78	5.3:1	9	✓
TWINPOWER FD 2500SHG	✓	MICRO MODULE II	✓	✓	ALUMINIUM		✓	✓	✓	✓	✓	210	9	89	6.0:1	4	✓
TWINPOWER FD C3000	✓	MICRO MODULE II	✓	✓	ALUMINIUM		✓	✓	✓	✓	✓	215	9	78	5.3:1	9	✓
TWINPOWER FD C3000M HG	✓	MICRO MODULE II	✓	✓	ALUMINIUM		✓	✓	✓	✓	✓	215	9	89	6.0:1	9	✓
TWINPOWER FD C3000XG	✓	MICRO MODULE II	✓	✓	ALUMINIUM		✓	✓	✓	✓	✓	215	9	94	6.4:1	9	✓
TWINPOWER FD 4000	✓	MICRO MODULE II	✓	✓	ALUMINIUM		✓	✓	✓	✓	✓	255	9	87	5.3:1	11	✓
TWINPOWER FD 4000PG	✓	MICRO MODULE II	✓	✓	ALUMINIUM		✓	✓	✓	✓	✓	260	9	72	4.4:1	11	✓
TWINPOWER FD 4000XG	✓	MICRO MODULE II	✓	✓	ALUMINIUM		✓	✓	✓	✓	✓	260	9	101	6.2:1	11	✓
TWINPOWER FD 4000MHG	✓	MICRO MODULE II	✓	✓	ALUMINIUM		✓	✓	✓	✓	✓	255	9	95	5.8:1	11	✓
TWINPOWER FD 1000	✓	MICRO MODULE II	✓	✓	ALUMINIUM		✓	✓	✓	✓	✓	260	9	101	6.2:1	11	✓
STRADIC 1000 FL	✓	MICRO MODULE II	✓	✓	ALUMINIUM		✓	✓	✓	✓	✓	185	6	64	5.1:1	3	✓
STRADIC 1000 HG FL	✓	MICRO MODULE II	✓	✓	ALUMINIUM		✓	✓	✓	✓	✓	185	6	75	6.0:1	3	✓
STRADIC 2500 FL	✓	MICRO MODULE II	✓	✓	ALUMINIUM		✓	✓	✓	✓	✓	220	6	78	5.3:1	9	✓
STRADIC 2500 HG FL	✓	MICRO MODULE II	✓	✓	ALUMINIUM		✓	✓	✓	✓	✓	225	6	89	6.0:1	9	✓
STRADIC C3000 FL	✓	MICRO MODULE II	✓	✓	ALUMINIUM		✓	✓	✓	✓	✓	225	6	78	5.3:1	9	✓
STRADIC C3000 HG FL	✓	MICRO MODULE II	✓	✓	ALUMINIUM		✓	✓	✓	✓	✓	225	6	89	6.0:1	9	✓
STRADIC C3000 XG FL	✓	MICRO MODULE II	✓	✓	ALUMINIUM		✓	✓	✓	✓	✓	225	6	94	6.4:1	9	✓
STRADIC 4000 FL	✓	MICRO MODULE II	✓	✓	ALUMINIUM		✓	✓	✓	✓	✓	280	6	87	5.3:1	11	✓
STRADIC 4000 MHG FL	✓	MICRO MODULE II	✓	✓	ALUMINIUM		✓	✓	✓	✓	✓	280	6	95	5.8:1	11	✓
STRADIC 4000 XG FL	✓	MICRO MODULE II	✓	✓	ALUMINIUM		✓	✓	✓	✓	✓	280	6	101	6.2:1	11	✓
STRADIC C5000 XG FL	✓	MICRO MODULE II	✓	✓	ALUMINIUM		✓	✓	✓	✓	✓	295	6	101	6.2:1	11	✓
ULTEGRA FC 1000	✓	MICRO MODULE II	✓		Ci4+		✓	✓	✓	✓	✓	180	5	64	5.1:1	3	✓
ULTEGRA FC C2000S	✓	MICRO MODULE II	✓		Ci4+		✓	✓	✓	✓	✓	185	5	69	5.1:1	3	✓
ULTEGRA FC C2000 HG	✓	MICRO MODULE II	✓		Ci4+		✓	✓	✓	✓	✓	185	5	82	6.1:1	3	✓
ULTEGRA FC C2000S HG	✓	MICRO MODULE II	✓		Ci4+		✓	✓	✓	✓	✓	185	5	82	6.1:1	3	✓
ULTEGRA FC 2500	✓	MICRO MODULE II	✓		Ci4+		✓	✓	✓	✓	✓	225	5	78	5.3:1	9	✓
ULTEGRA FC 2500 HG	✓	MICRO MODULE II	✓		Ci4+		✓	✓	✓	✓	✓	225	5	89	6.0:1	9	✓
ULTEGRA FC 2500S HG	✓	MICRO MODULE II	✓		Ci4+		✓	✓	✓	✓	✓	220	5	89	6.0:1	4	✓
ULTEGRA FC C3000	✓	MICRO MODULE II	✓		Ci4+		✓	✓	✓	✓	✓	225	5	78	5.3:1	9	✓
ULTEGRA FC C3000 HG	✓	MICRO MODULE II	✓		Ci4+		✓	✓	✓	✓	✓	225	5	89	6.0:1	9	✓
ULTEGRA FC C3000 XG	✓	MICRO MODULE II	✓		Ci4+		✓	✓	✓	✓	✓	225	5	94	6.4:1	9	✓
ULTEGRA FC 4000	✓	MICRO MODULE II	✓		Ci4+		✓	✓	✓	✓	✓	270	5	87	5.3:1	11	✓
ULTEGRA FC 4000 XG	✓	MICRO MODULE II	✓		Ci4+		✓	✓	✓	✓	✓	270	5	101	6.2:1	11	✓
ULTEGRA FC C5000 XG	✓	MICRO MODULE II	✓		Ci4+		✓	✓	✓	✓	✓	285	5	101	6.2:1	11	✓
SOARE BB 2000	✓	CF ALU	✓		XT-7		✓	✓	✓	✓	✓	200	5	57	4.3:1	3	✓
SEPHIA BB 3000	✓	CF ALU	✓		XT-7		✓	✓	✓	✓	✓	235	5	73	5.0:1	9	✓
VANQUISH FB 1000SSS PG	✓	MICRO MODULE	✓	✓	MAGNESIUM	✓	✓	✓	✓	✓	✓	145	11	58	5.1:1	3	✓
VANQUISH FB C2000S	✓	MICRO MODULE	✓	✓	MAGNESIUM	✓	✓	✓	✓	✓	✓	145	11	69	5.1:1	3	✓
VANQUISH FB C2500S HG	✓	MICRO MODULE	✓	✓	MAGNESIUM	✓	✓	✓	✓	✓	✓	155	11	81	6.0:1	3	✓
VANQUISH FB 2500S	✓	MICRO MODULE	✓	✓	MAGNESIUM	✓	✓	✓	✓	✓	✓	165	11	78	5.3:1	4	✓
VANQUISH FB 2500S HG	✓	MICRO MODULE	✓	✓	MAGNESIUM	✓	✓	✓	✓	✓	✓	165	11	89	6.0:1	4	✓
VANQUISH FB C3000	✓	MICRO MODULE	✓	✓	MAGNESIUM	✓	✓	✓	✓	✓	✓	170	11	78	5.3:1	9	✓
VANQUISH FB C3000M HG	✓	MICRO MODULE	✓	✓	MAGNESIUM	✓	✓	✓	✓	✓	✓	170	11	89	6.0:1	9	✓
VANQUISH FB 4000M HG	✓	MICRO MODULE	✓	✓	MAGNESIUM	✓	✓	✓	✓	✓	✓	205	11	95	5.8:1	11	✓
VANQUISH FB 4000 XG	✓	MICRO MODULE	✓	✓	MAGNESIUM	✓	✓	✓	✓	✓	✓	200	11	101	6.2:1	11	✓
VANQUISH FB C5000 XG	✓	MICRO MODULE	✓	✓	MAGNESIUM	✓	✓	✓	✓	✓	✓	220	11	101	6.2:1	11	✓
TWINPOWER XD FA C3000 HG	✓	CF ALU	✓	✓	ALUMINIUM	✓	✓	✓	✓	✓	✓	200	10	89	6.0:1	9	✓
TWINPOWER XD FA C3000 XG	✓	CF ALU	✓	✓	ALUMINIUM	✓	✓	✓	✓	✓	✓	200	10	94	6.4:1	9	✓
TWINPOWER XD FA 4000 PG	✓	CF ALU	✓	✓	ALUMINIUM	✓	✓	✓	✓	✓	✓	245	10	72	4.4:1	11	✓
TWINPOWER XD FA 4000 HG	✓	CF ALU	✓	✓	ALUMINIUM	✓	✓	✓	✓	✓	✓	245	10	95	5.8:1	11	✓
TWINPOWER XD FA 4000 XG	✓	CF ALU	✓	✓	ALUMINIUM	✓	✓	✓	✓	✓	✓	245	10	101	6.2:1	11	✓
TWINPOWER XD FA C5000 XG	✓	CF ALU	✓	✓	ALUMINIUM	✓	✓	✓	✓	✓	✓	245	10	101	6.2:1	11	✓
SUSTAIN FJ 2500	✓	MICRO MODULE II	✓	✓	ALUMINIUM + XT-7	✓	✓	✓	✓	✓	✓	210	8	78	5.3:1	9	✓
SUSTAIN FJ 2500 HG	✓	MICRO MODULE II	✓	✓	ALUMINIUM + XT-7	✓	✓	✓	✓	✓	✓	210	8	89	6.0:1	9	✓
SUSTAIN FJ C3000	✓	MICRO MODULE II	✓	✓	ALUMINIUM + XT-7	✓	✓	✓	✓	✓	✓	210	8	78	5.3:1	9	✓
SUSTAIN FJ C3000 HG	✓	MICRO MODULE II	✓	✓	ALUMINIUM + XT-7	✓	✓	✓	✓	✓	✓	210	8	89	6.0:1	9	✓
SUSTAIN FJ C3000 XG	✓	MICRO MODULE II	✓	✓	ALUMINIUM + XT-7	✓	✓	✓	✓	✓	✓	210	8	94	6.4:1	9	✓
SUSTAIN FJ 4000	✓	MICRO MODULE II	✓	✓	ALUMINIUM + XT-7	✓	✓	✓	✓	✓	✓	260	8	87	5.3:1	11	✓
SUSTAIN FJ 4000 HG	✓	MICRO MODULE II	✓	✓	ALUMINIUM + XT-7	✓	✓	✓	✓	✓	✓	260	8	95	5.8:1	11	✓
SUSTAIN FJ 4000 XG	✓	MICRO MODULE II	✓	✓	ALUMINIUM + XT-7	✓	✓	✓	✓	✓	✓	275	8	101	6.2:1	11	✓
SUSTAIN FJ C5000 XG	✓	MICRO MODULE II	✓	✓	ALUMINIUM + XT-7	✓	✓	✓	✓	✓	✓	270	8	101	6.2:1	11	✓
VANFORD 500	✓	MICRO MODULE II	✓		Ci4+	✓	✓	✓	✓	✓	✓	140	6	69	5.6:1	2.5	✓
VANFORD 1000	✓	MICRO MODULE II	✓		Ci4+	✓	✓	✓	✓	✓	✓	150	7	64	5.1:1	3	✓
VANFORD C2000S	✓	MICRO MODULE II	✓		Ci4+	✓	✓	✓	✓	✓	✓	150	7	69	5.1:1	3	✓
VANFORD C2000S HG	✓	MICRO MODULE II	✓		Ci4+	✓	✓	✓	✓	✓	✓	150	7	82	6.1:1	3	✓
VANFORD 2500	✓	MICRO MODULE II	✓		Ci4+	✓	✓	✓	✓	✓	✓	180	7	78	5.3:1	9	✓
VANFORD 2500S	✓	MICRO MODULE II	✓		Ci4+	✓	✓	✓	✓	✓	✓	175	7	78	5.3:1	4	✓
VANFORD 2500S HG	✓	MICRO MODULE II	✓		Ci4+	✓	✓	✓	✓	✓	✓	175	7	89	6.0:1	4	✓
VANFORD 2500 HG	✓	MICRO MODULE II	✓		Ci4+	✓	✓	✓	✓	✓	✓	180	7	89	6.0:1	9	✓

MODEL	HAGANE GEAR	DRIVE GEAR	X-SHIP	HAGANE BODY	BODY MATERIAL	MGL ROTOR	X-PROTECT	SILENTDRIVE	G Free BODY	AR-C SPOOL	ONE-PIECE BAIL	WEIGHT (G)	BB QTY	LINE RETRIEVE PER CRANK(CM)	GEAR RATIO	MAX DRAG FORCE(KG)	WATER PROOF DRAG	
<b>FRONT DRAG</b>																		
VANFORD C3000	✓	MICRO MODULE II	✓		Ci4+	✓	✓	✓	✓	✓	✓	180	7	78	5.3:1	9	✓	
VANFORD C3000 HG	✓	MICRO MODULE II	✓		Ci4+	✓	✓	✓	✓	✓	✓	180	7	89	6.0:1	9	✓	
VANFORD 4000	✓	MICRO MODULE II	✓		Ci4+	✓	✓	✓	✓	✓	✓	215	7	87	5.3:1	11	✓	
VANFORD 4000M HG	✓	MICRO MODULE II	✓		Ci4+	✓	✓	✓	✓	✓	✓	215	7	95	5.8:1	11	✓	
VANFORD 4000 XG	✓	MICRO MODULE II	✓		Ci4+	✓	✓	✓	✓	✓	✓	215	7	101	6.2:1	11	✓	
VANFORD C5000 XG	✓	MICRO MODULE II	✓		Ci4+	✓	✓	✓	✓	✓	✓	220	7	101	6.2:1	11	✓	
EXSENCE A C3000M HG	✓	MICRO MODULE II	✓	✓	MAGNESIUM	✓	✓	✓	✓	✓	✓	180	11	88	6.0:1	9	✓	
EXSENCE A 4000M XG	✓	MICRO MODULE II	✓	✓	MAGNESIUM	✓	✓	✓	✓	✓	✓	220	11	99	6.2:1	11	✓	
CARDIFF CI4+ 1000S	✓	CF ALU	✓			✓			✓	✓	✓	170	9	66	5.0:1	3	✓	
CARDIFF CI4+ C3000M HG	✓	CF ALU	✓		Ci4+	✓	✓		✓	✓	✓	200	9	88	6.0:1	9	✓	
NASCI FC 500	✓	CF ALU	✓		XT-7			✓	✓	✓	✓	170	4	69	5.6:1	3	✓	
NASCI FC 1000	✓	CF ALU	✓		XT-7			✓	✓	✓	✓	205	5	66	5.0:1	3	✓	
NASCI FC C2000S	✓	CF ALU	✓		XT-7			✓	✓	✓	✓	210	5	66	5.0:1	3	✓	
NASCI FC C2000S HG	✓	CF ALU	✓		XT-7			✓	✓	✓	✓	210	5	79	6.0:1	3	✓	
NASCI FC 2500	✓	CF ALU	✓		XT-7			✓	✓	✓	✓	240	5	73	5.0:1	9	✓	
NASCI FC 2500S HG	✓	CF ALU	✓		XT-7			✓	✓	✓	✓	240	5	91	6.2:1	4	✓	
NASCI FC 2500 HG	✓	CF ALU	✓		XT-7			✓	✓	✓	✓	240	5	91	6.2:1	9	✓	
NASCI FC C3000	✓	CF ALU	✓		XT-7			✓	✓	✓	✓	240	5	73	5.0:1	9	✓	
NASCI FC C3000 HG	✓	CF ALU	✓		XT-7			✓	✓	✓	✓	240	5	91	6.2:1	9	✓	
NASCI FC 4000	✓	CF ALU	✓		XT-7			✓	✓	✓	✓	285	5	75	4.7:1	11	✓	
NASCI FC 4000 XG	✓	CF ALU	✓		XT-7			✓	✓	✓	✓	285	5	99	6.2:1	11	✓	
NASCI FC C5000 XG	✓	CF ALU	✓		XT-7			✓	✓	✓	✓	305	5	105	6.2:1	11	✓	
SAHARA FJ 500	✓	CF ALU	✓		XT-7			✓	✓	✓	✓	170	3	69	5.6:1	3		
SAHARA FJ 1000	✓	CF ALU	✓		XT-7			✓	✓	✓	✓	205	4	66	5.0:1	3		
SAHARA FJ C2000	✓	CF ALU	✓		XT-7			✓	✓	✓	✓	210	4	66	5.0:1	3		
SAHARA FJ C2000S HG	✓	CF ALU	✓		XT-7			✓	✓	✓	✓	210	4	79	6.0:1	3		
SAHARA FJ 2500	✓	CF ALU	✓		XT-7			✓	✓	✓	✓	240	4	73	5.0:1	9		
SAHARA FJ 2500S HG	✓	CF ALU	✓		XT-7			✓	✓	✓	✓	240	4	91	6.2:1	4		
SAHARA FJ C3000	✓	CF ALU	✓		XT-7			✓	✓	✓	✓	240	4	73	5.0:1	9		
SAHARA FJ C3000 HG	✓	CF ALU	✓		XT-7			✓	✓	✓	✓	240	4	91	6.2:1	9		
SAHARA FJ C3000 DH	✓	CF ALU	✓		XT-7			✓	✓	✓	✓	265	4	73	5.0:1	9		
SAHARA FJ 4000	✓	CF ALU	✓		XT-7			✓	✓	✓	✓	280	4	75	4.7:1	11		
SAHARA FJ 4000 XG	✓	CF ALU	✓		XT-7			✓	✓	✓	✓	280	4	99	6.2:1	11		
SAHARA FJ C5000 XG	✓	CF ALU	✓		XT-7			✓	✓	✓	✓	305	4	105	6.2:1	11		
SEDONA FI 500		ZINC DIECAST			XT-7				✓	✓	✓	185	3	69	5.6:1	2.5		
SEDONA FI 1000	✓	CF ALU			XT-7				✓	✓	✓	215	3	66	5.0:1	3		
SEDONA FI C2000S	✓	CF ALU			XT-7				✓	✓	✓	215	3	66	5.0:1	3		
SEDONA FI C2000S HG	✓	CF ALU			XT-7				✓	✓	✓	215	3	79	6.0:1	3		
SEDONA FI 2500	✓	CF ALU			XT-7				✓	✓	✓	245	3	73	5.0:1	4		
SEDONA FI 2500 HG	✓	CF ALU			XT-7				✓	✓	✓	245	3	91	6.2:1	4		
SEDONA FI 2500S	✓	CF ALU			XT-7				✓	✓	✓	245	3	73	5.0:1	4		
SEDONA FI C3000	✓	CF ALU			XT-7				✓	✓	✓	250	3	73	5.0:1	9		
SEDONA FI C3000 HG	✓	CF ALU			XT-7				✓	✓	✓	250	3	91	6.2:1	9		
SEDONA FI C3000 DH	✓	CF ALU			XT-7				✓	✓	✓	275	3	73	5.0:1	9		
SEDONA FI 4000	✓	CF ALU			XT-7				✓	✓	✓	295	3	75	4.7:1	11		
SEDONA FI 4000 XG	✓	CF ALU			XT-7				✓	✓	✓	295	3	99	6.2:1	11		
SEDONA FI C5000 XG	✓	CF ALU			XT-7				✓	✓	✓	300	3	105	6.2:1	11		
SEDONA FI 6000	✓	CF ALU			XT-7				✓	✓	✓	425	3	83	4.6:1	10		
SEDONA FI 8000	✓	CF ALU			XT-7				✓	✓	✓	615	3	94	4.9:1	11		
NEXAVE FI 1000		ZINC DIECAST			XT-7					✓	✓	220	3	66	5.0:1			
NEXAVE FI 2500		ZINC DIECAST			XT-7					✓	✓	250	3	73	5.0:1			
NEXAVE FI 2500S		ZINC DIECAST			XT-7					✓	✓	265	3	73	5.0:1	4		
NEXAVE FI 2500 HG		ZINC DIECAST			XT-7					✓	✓	250	3	91	6.0:1	4		
NEXAVE FI C3000		ZINC DIECAST			XT-7					✓	✓	255	3	73	5.0:1	9		
NEXAVE FI C3000 HG		ZINC DIECAST			XT-7					✓	✓	255	3	91	6.2:1	9		
NEXAVE FI 4000		ZINC DIECAST			XT-7					✓	✓	305	3	83	5.2:1	11		
NEXAVE FI 4000 HG		ZINC DIECAST			XT-7					✓	✓	305	3	93	5.8:1	11		
NEXAVE FI C5000 XG		ZINC DIECAST			XT-7					✓	✓	305	3	98	5.8:1	11		
NEXAVE FE 6000		ZINC DIECAST			XT-7					✓	✓	595	3	91	4.9:1	8		
NEXAVE FE 8000		ZINC DIECAST			XT-7					✓	✓	580	3	92	4.9:1	8		
CATANA FE 1000		ZINC DIECAST			XT-7				✓	✓	✓	230	3	66	5.0:1	3		
CATANA FE 2500		ZINC DIECAST			XT-7				✓	✓	✓	260	3	73	5.0:1	4		
CATANA FE 2500 HG		ZINC DIECAST			XT-7				✓	✓	✓	260	3	91	6.2:1	4		
CATANA FE C3000		ZINC DIECAST			XT-7				✓	✓	✓	260	3	73	5.0:1	8.5		
CATANA FE C3000 HG		ZINC DIECAST			XT-7				✓	✓	✓	260	3	91	6.2:1	8.5		
CATANA FE 4000		ZINC DIECAST			XT-7				✓	✓	✓	320	3	83	5.2:1	8.5		
CATANA FE 4000 HG		ZINC DIECAST			XT-7				✓	✓	✓	320	3	93	5.8:1	8.5		
ALIVIO FA 6000		ZINC DIECAST			XT-7					✓	✓	590	1	90	4.9:1	8		
ALIVIO FA 10000		ZINC DIECAST			XT-7					✓	✓	580	1	94	4.9:1	8		
SIENNA FG 500		ZINC DIECAST			XT-7					✓	✓	195	3	69	5.6:1	2		
SIENNA FG 1000		ZINC DIECAST			XT-7					✓	✓	225	3	66	5.0:1	3		
SIENNA FG 2000		ZINC DIECAST			XT-7					✓	✓	250	3	71	5.0:1	4		
SIENNA FG 2500		ZINC DIECAST			XT-7					✓	✓	250	3	71	5.0:1	4		
SIENNA FG 2500 HG		ZINC DIECAST			XT-7					✓	✓	250	3	88	6.2:1	4		
SIENNA FG C3000		ZINC DIECAST			XT-7					✓	✓	250	3	71	5.0:1	8.5		
SIENNA FG 4000		ZINC DIECAST			XT-7					✓	✓	320	3	82	5.2:1	8.5		
FX FC 1000		ZINC DIECAST			XT-7					✓	✓	225	2	66	5.0:1	3		
FX FC 2000		ZINC DIECAST			XT-7					✓	✓	250	2	71	5.0:1	4		
FX FC 2500		ZINC DIECAST			XT-7					✓	✓	250	2	71	5.0:1	4		
FX FC 2500 HG		ZINC DIECAST			XT-7					✓	✓	250	2	88	6.2:1	4		
FX FC C3000		ZINC DIECAST			XT-7					✓	✓	250	2	71	5.0:1	8.5		
FX FC 4000		ZINC DIECAST			XT-7					✓	✓	320	2	82	5.2:1	8.5		

# REEL SPECIFICATIONS

MODEL	HAGANE GEAR	SPOOL MATERIAL /TYPE	AR-C SPOOL	BODY MATERIAL	OSCILLATION	ONE-PIECE BAIL	WEIGHT (G)	BB QTY	LINE RETRIEVE PER CRANK(CM)	GEAR RATIO	LINE CAPACITY	DRAG TYPE	MAX DRAG FORCE (KG)	FIGHTIN' DRAG TECHNOLOGY
<b>REAR DRAG REELS</b>														
STRADIC CI4+ 2500RA	✓	COLD FORGED ALU	✓	Ci4+	AERO WRAP	✓	255	5	98	6.0:1	0,20mm-240m	RD II	2.5	✓
STRADIC CI4+ 4000RA	✓	COLD FORGED ALU	✓	Ci4+	AERO WRAP	✓	310	5	93	5.2:1	0,25mm-260m	RD II	3	✓
STRADIC GTM-RC 2500		ZINC DIECAST	✓	XT-7	AERO WRAP		315	4	88	6.0:1	0,20mm-240m	RD II	2.5	✓
STRADIC GTM-RC 3000		ZINC DIECAST	✓	XT-7	AERO WRAP		345	4	92	6.0:1	0,25mm-140m	RD II	2.5	✓
STRADIC GTM-RC 4000		ZINC DIECAST	✓	XT-7	AERO WRAP		390	4	95	5.8:1	0,30mm-100m	RD II	3	✓
SUPER GT-RD 2500		ZINC DIECAST	✓	XT-7	AERO WRAP		290	3	82	5.0:1	0,20mm-240m	RD II	2.5	✓
SUPER GT-RD 4000		ZINC DIECAST	✓	XT-7	AERO WRAP		355	3	86	4.8:1	0,25mm-260m	RD II	3	✓
SAHARA RD 1000		ZINC DIECAST	✓	XT-7	AERO WRAP		255	3	69	5.2:1	0,20mm-140m	RD II	2	✓
SAHARA RD 2500		ZINC DIECAST	✓	XT-7	VARISPEED		275	3	76	5.2:1	0,25mm-160m	RD II	2	✓
SAHARA RD 3000S		ZINC DIECAST	✓	XT-7	VARISPEED		280	3	76	5.2:1	0,25mm-140m	RD II	2	✓
SAHARA RD 4000		ZINC DIECAST	✓	XT-7	VARISPEED		320	3	82	5.1:1	0,30mm-180m	RD II	3	✓
SAHARA RD 2500 D		ZINC DIECAST	✓	XT-7	VARISPEED		335	3	76	5.2:1	0,25mm-160m	RD II	2	✓
SAHARA RD 3000SS HG DH		ZINC DIECAST	✓	XT-7	VARISPEED		335	3	91	6.2:1	0,18mm-130m	RD II	2	✓
SAHARA RD 4000 DH		ZINC DIECAST	✓	XT-7	VARISPEED		375	3	82	5.1:1	0,30mm-180m	RD II	3	✓
CATANA RC 1000		ZINC DIECAST	✓	XT-7	VARISPEED		270	2	69	5.2:1	0,18mm-170m	RD II	2	
CATANA RC 2500		ZINC DIECAST	✓	XT-7	VARISPEED		300	2	76	5.2:1	0,20mm-240m	RD II	2	
CATANA RC 3000S		ZINC DIECAST	✓	XT-7	VARISPEED		300	2	76	5.2:1	0,18mm-240m	RD II	2	
CATANA RC 4000		ZINC DIECAST	✓	XT-7	VARISPEED		370	2	82	5.1:1	0,30mm-180m	RD II	3	
SIENNA RE 1000		ZINC DIECAST	✓	XT-7	VARISPEED		270	1	69	5.2:1	0,18mm-170m	RD II	2	
SIENNA RE 2500		ZINC DIECAST	✓	XT-7	VARISPEED		300	1	76	5.2:1	0,20mm-240m	RD II	2	
SIENNA RE 4000		ZINC DIECAST	✓	XT-7	VARISPEED		365	1	82	5.1:1	0,25mm-260m	RD II	3	

MODEL	HAGANE GEAR	X-SHIP	HAGANE BODY	BODY MATERIAL	OSCILLATION SPEED	PARALLEL BODY	G FREE BODY	X-PROTECT	AR-C SPOOL	ONE-PIECE BAIL	WEIGHT (G)	BB QTY	LINE RETRIEVE PER CRANK (CM)	GEAR RATIO	MAX DRAG FORCE (KG)	WATER PROOF DRAG
<b>BIG PIT REELS</b>																
AERO TECHNIUM MGS XTD 14000	✓	✓	✓	Ci4+	SUPER SLOW 10	✓	✓	✓	✓	✓	510	8	103	4.3:1	20	✓
AERO TECHNIUM MGS XSD 14000	✓	✓	✓	Ci4+	SUPER SLOW 10	✓	✓	✓	✓	✓	510	8	103	4.3:1	20	✓
FLIEGEN 35 SD	✓	✓	✓	DIECAST ALU		✓	✓	✓	✓	✓	490	8	84	3.5:1	20	✓
POWER AERO XTB 14000	✓	✓	✓	DIECAST ALU	SUPER SLOW 5	✓	✓	✓	✓	✓	510	8	103	4.3:1	20	✓
POWER AERO XSB 14000	✓	✓	✓	DIECAST ALU	SUPER SLOW 5	✓	✓	✓	✓	✓	510	8	103	4.3:1	20	✓
BULLS EYE 9100	✓	✓	✓	DIECAST ALU	SLOW	✓	✓	✓	✓	✓	540	5	84	3.5:1	20	✓
BULLS EYE 9120	✓	✓	✓	DIECAST ALU	SLOW	✓	✓	✓	✓	✓	540	5	84	3.5:1	20	✓
SURF LEADER CI4+ 35 SD	✓	✓	✓	Ci4+		✓	✓	✓	✓	✓	535	4	84	3.5:1	20	✓
ULTEGRA CI4+ XTC 5500	✓	✓	✓	Ci4+	SLOW	✓	✓	✓	✓	✓	440	5	105	5.3:1	15	✓
ULTEGRA CI4+ XTC 14000	✓	✓	✓	Ci4+	SUPER SLOW 5	✓	✓	✓	✓	✓	540	5	103	4.3:1	20	✓
ULTEGRA CI4+ XSC 5500	✓	✓	✓	Ci4+	SLOW	✓	✓	✓	✓	✓	440	5	105	5.3:1	15	✓
ULTEGRA CI4+ XSC 14000	✓	✓	✓	Ci4+	SUPER SLOW 5	✓	✓	✓	✓	✓	540	5	103	4.3:1	20	✓
ULTEGRA XTD 5500		✓	✓	XT-7	SLOW	✓	✓	✓	✓	✓	500	4	105	5.3:1	15	
ULTEGRA XTD SPOD		✓	✓	XT-7	SUPER SLOW 5	✓	✓	✓	✓	✓	630	4	124	5.2:1	20	
ULTEGRA XSD 3500 COMPETITION		✓	✓	XT-7	SUPER SLOW 5	✓	✓	✓	✓	✓	645	4	103	4.3:1	20	
ULTEGRA XSD 5500		✓	✓	XT-7	SLOW	✓	✓	✓	✓	✓	500	4	105	5.3:1	15	
SPEEDMASTER XTC 14000		✓	✓	XT-7	SUPER SLOW 5	✓	✓	✓	✓	✓	625	4	103	4.3:1	20	
SPEEDMASTER XSC 14000		✓	✓	XT-7	SUPER SLOW 5	✓	✓	✓	✓	✓	625	4	103	4.3:1	20	
AERLEX XTB 10000				XT-7	NORMAL				✓	✓	645	2	100	4.6:1	15	
AERLEX XSB 10000 SPOD				XT-7	NORMAL				✓	✓	650	2	115	5.3:1	15	
AERLEX XSB 10000				XT-7	NORMAL				✓	✓	645	2	100	4.6:1	15	
BEASTMASTER XB 10000				XT-7	NORMAL				✓	✓	705	1	100	4.6:1	15	
<b>FREESPOOL REELS</b>																
BAITRUNNER CI4+ XTB MEDIUM LC	✓	✓		Ci4+	SLOW			✓	✓		510	6	105	5.3:1	15	✓
BAITRUNNER CI4+ XTB BIG LC	✓	✓		Ci4+	SLOW			✓	✓		640	6	110	4.6:1	20	✓
BAITRUNNER XTB MEDIUM LC	✓	✓		XT-7	SLOW				✓		560	4	105	5.3:1	15	
BAITRUNNER XTB BIG LC	✓	✓		XT-7	SLOW				✓		720	4	110	4.6:1	20	
BAITRUNNER X-AERO FB		✓		XT-7	NORMAL				✓		420	8	86	4.8:1	4	
BAITRUNNER X-AERO RA 6000				HYBRID	NORMAL				✓		615	8	96	4.6:1	5	
BAITRUNNER X-AERO RA 8000				HYBRID	NORMAL				✓		580	6	96	4.6:1	5	
BAITRUNNER X-AERO RA 10000				HYBRID	NORMAL				✓		590	6	99	4.6:1	5	
BAITRUNNER D 4000				XT-7	NORMAL				✓	✓	385	3	71	4.8:1	7	✓
BAITRUNNER D 6000				XT-7	NORMAL				✓	✓	570	3	89	4.8:1	9	✓
BAITRUNNER D 8000				XT-7	NORMAL				✓	✓	615	3	91	4.8:1	9	✓
BAITRUNNER D 12000				XT-7	NORMAL				✓	✓	850	3	93	4.4:1	12	✓
BAITRUNNER D 6000 EU				XT-7	NORMAL				✓	✓	550	3	89	4.8:1	9	✓
BAITRUNNER D 8000 EU				XT-7	NORMAL				✓	✓	600	3	91	4.8:1	9	✓
BAITRUNNER OC 4000				XT-7	NORMAL				✓		380	3	71	4.8:1	7	✓
BAITRUNNER OC 6000				XT-7	NORMAL				✓		545	3	89	4.8:1	9	✓
BAITRUNNER OC 8000				XT-7	NORMAL				✓		590	3	91	4.8:1	9	✓
BAITRUNNER 10C 2000 OCEANIC				XT-7	NORMAL				✓		825	3	93	4.4:1	12	✓
BAITRUNNER XT-RB 6000				HYBRID	NORMAL				✓		610	3	85	4.8:1	8	
BAITRUNNER XT-RB 8000				HYBRID	NORMAL				✓		610	4	87	4.6:1	6	
BAITRUNNER XT-RB 10000				HYBRID	NORMAL				✓		610	4	88	4.6:1	6	
BAITRUNNER DL-RB 6000				XT-7	NORMAL				✓		590	3	85	4.6:1	6	
BAITRUNNER DL-RB 10000				XT-7	NORMAL				✓		595	3	87	4.6:1	6	
BAITRUNNER DL-FB 2500				XT-7	NORMAL				✓		360	3	68	4.8:1	3	
BAITRUNNER DL-FB 4000				XT-7	NORMAL				✓		415	3	75	4.8:1	6	

MODEL	HAGANE GEAR	X-SHIP	HAGANE BODY	BODY MATERIAL	OSCILLATION SPEED	PARALLEL BODY	G FREE BODY	X-PROTECT	AR-C SPOOL	ONE-PIECE BAIL	WEIGHT (G)	BB QTY	LINE RETRIEVE PER CRANK (CM)	GEAR RATIO	MAX DRAG FORCE (KG)	WATER PROOF DRAG
<b>FREESPOOL REELS</b>																
BAITRUNNER ST-RB 6000				XT-7	NORMAL				✓		550	1	85	4.6:1	6	
BAITRUNNER ST-RB 10000				XT-7	NORMAL				✓		555	1	87	4.6:1	6	
BAITRUNNER ST-FB 2500				XT-7	NORMAL				✓		310	1	68	4.8:1	3	
BAITRUNNER ST 4000 FB				XT-7	NORMAL				✓		355	1	75	4.8:1	6	

MODEL	BRAKE SYSTEM	MICRO MODULE	X-SHIP	HAGANE BODY	EXCITING DRAG SOUND	BODY MATERIAL	WEIGHT (G)	BB QTY	LINE RETRIEVE PER WINCH (CM)	GEAR RATIO	MAXDRAG FORCE (KG)
<b>BAITCASTING REELS</b>											
OCEA CONQUEST 201 PG	SVS	MICRO MODULE	✓	✓	✓	ALUMINIUM	275	12	60	4.8:1	6
OCEA CONQUEST 301 HG	SVS	MICRO MODULE	✓	✓	✓	ALUMINIUM	345	10	84	6.2:1	7
OCEA CONQUEST 301 PG	SVS	MICRO MODULE	✓	✓	✓	ALUMINIUM	340	10	65	4.8:1	8
CALCUTTA CONQUEST 201A	SVS	MICRO MODULE	✓	✓	✓	ALUMINIUM	235	12	57	4.8:1	6
CALCUTTA CONQUEST 301A	SVS	MICRO MODULE	✓	✓	✓	ALUMINIUM	330	12	84	6.2:1	7
CARDIFF A 201	VBS			✓		ALUMINIUM	230	4	61	5.8:1	5
CARDIFF A 301	VBS			✓		ALUMINIUM	252	4	61	5.8:1	5
CARDIFF A 401	VBS			✓		ALUMINIUM	337	4	56	5.2:1	5
CORVALUS 401	VBS			✓		ALUMINIUM	335	3	64	5.2:1	5
METANIUM DC 101 HG	i-DC5	MICRO MODULE	✓	✓		MAGNESIUM	190	9	79	7.4:1	5
METANIUM DC 101 XG	i-DC5	MICRO MODULE	✓	✓		MAGNESIUM	195	9	91	8.5:1	5
SLX DC XT 70HG	i-DC4	MICRO MODULE	✓	✓		ALU FRAME + Ci4+	195	7	77	7.4:1	-
SLX DC XT 71	i-DC4	MICRO MODULE	✓	✓		ALU FRAME + Ci4+	195	7	64	6.2:1	-
SLX DC XT 71HG	i-DC4	MICRO MODULE	✓	✓		ALU FRAME + Ci4+	195	7	77	7.4:1	-
SLX DC XT 71XG	i-DC4	MICRO MODULE	✓	✓		ALU FRAME + Ci4+	195	7	84	8.1:1	-
CURADO DC 151	i-DC4	MICRO MODULE	✓	✓		ALU + Ci4+	220	6	66	6.2:1	5
CURADO DC 151 HG	i-DC4	MICRO MODULE	✓	✓		ALU + Ci4+	220	6	79	7.4:1	5
CURADO DC 151 XG	i-DC4	MICRO MODULE	✓	✓		ALU + Ci4+	225	6	91	8.5:1	5
CURADO DC 200 HG	i-DC4	MICRO MODULE	✓	✓		ALU + Ci4+	230	6	81	7.4:1	-
CURADO DC 201 HG	i-DC4	MICRO MODULE	✓	✓		ALU + Ci4+	230	6	81	7.4:1	-
CURADO DC 201 XG	i-DC4	MICRO MODULE	✓	✓		ALU + Ci4+	230	6	91	8.5:1	-
SLX DC 151	i-DC4			✓		ALU FRAME + HIGH STR RESIN	215	4	93	6.2:1	5.5
SLX DC 151 HG	i-DC4			✓		ALU FRAME + HIGH STR RESIN	215	4	77	6.3:1	5
SLX DC 151 XG	i-DC4			✓		ALU FRAME + HIGH STR RESIN	215	4	88	7.2:1	5
ANTARES 5RL173000	SVS		✓	✓		MAGNESIUM	220	10	79	7.4:1	5
ALDEBARAN MGL 51	SVS		✓	✓		MAGNESIUM	135	9	65	6.5:1	4.5
ALDEBARAN MGL 51 HG	SVS		✓	✓		MAGNESIUM	135	9	74	7.4:1	4.5
METANIUM MGL 151	SVS	MICRO MODULE	✓	✓		MAGNESIUM	180	10	66	6.2:1	5
METANIUM MGL 151 HG	SVS	MICRO MODULE	✓	✓		MAGNESIUM	180	10	76	7.1:1	5
METANIUM MGL 151 XG	SVS	MICRO MODULE	✓	✓		MAGNESIUM	185	10	86	8.1:1	5
BANTAM MGL 151 A	SVS	MICRO MODULE	✓	✓		ALUMINIUM	215	8	68	6.2:1	5
BANTAM MGL 151 HG A	SVS	MICRO MODULE	✓	✓		ALUMINIUM	220	8	78	7.1:1	5
BANTAM MGL 151 XG A	SVS	MICRO MODULE	✓	✓		ALUMINIUM	225	8	89	8.1:1	5
CURADO K MGL 150	SVS	MICRO MODULE	✓			Ci4+ + XT-7	190	6	62	6.2:1	6
CURADO K MGL 151	SVS	MICRO MODULE	✓			Ci4+ + XT-7	190	6	62	6.2:1	6
CURADO K MGL 151 HG	SVS	MICRO MODULE	✓			Ci4+ + XT-7	190	6	74	7.4:1	6
CURADO K MGL 151 XG	SVS	MICRO MODULE	✓			Ci4+ + XT-7	190	6	81	8.1:1	6
CURADO K MGL 71 HG	SVS	MICRO MODULE	✓			Ci4+	195	8	74	7.4:1	5.5
CURADO K MGL 71 XG	SVS	MICRO MODULE	✓			Ci4+	195	8	81	8.1:1	5.5
SLX MGL 70	SVS			✓		ALUMINIUM	200	4	63	6.3:1	5.5
SLX MGL 71 HG	SVS			✓		ALUMINIUM	200	4	72	7.2:1	5.5
SLX MGL 71 XG	SVS			✓		ALUMINIUM	200	4	82	8.2:1	5.5
CURADO 201 K	SVS	MICRO MODULE	✓	✓		ALU + Ci4+	215	6	66	8.2:1	5
CURADO 201 K PG	SVS	MICRO MODULE	✓	✓		ALU + Ci4+	220	6	53	5.0:1	5
CURADO 201 K HG	SVS	MICRO MODULE	✓	✓		ALU + Ci4+	215	6	79	7.4:1	5
GRAPPLER BB 201HG	SVS		✓			Ci4+	185	4	77	7.2:1	5.5
SLX XT 151	SVS			✓		ALU FRAME + HIGH STR RESIN	205	4	63	6.3:1	5.5
SLX XT 151 HG	SVS			✓		ALU FRAME + HIGH STR RESIN	205	4	72	7.2:1	5
SLX XT 151 XG	SVS			✓		ALU FRAME + HIGH STR RESIN	205	4	82	8.2:1	5
ALDEBARAN BFS HG RIGHT	FTB	MICRO MODULE	✓	✓	✓	MAGNESIUM + Ci4+	130	10	71	7.8:1	3.5
ALDEBARAN BFS XG LEFT	FTB	MICRO MODULE	✓	✓	✓	MAGNESIUM + Ci4+	130	10	81	8.9:1	3.5
CURADO BFS HG RIGHT	FTB		✓	✓	✓	ALU FRAME + HIGH STR RESIN	175	7	82	8.2:1	3.5
CURADO BFS XG LEFT	FTB		✓	✓	✓	ALU FRAME + HIGH STR RESIN	175	7	82	8.2:1	3.5
TRANX A 301 LEFT	VBS		✓	✓		ALUMINIUM	330	5	75	5.8:1	10
TRANX A 301 HG LEFT	VBS		✓	✓		ALUMINIUM	330	5	100	7.6:1	8
TRANX A 401 HG LEFT	VBS		✓	✓		ALUMINIUM	340	5	100	7.6:1	8
TRANX A 401 LEFT	VBS		✓	✓		ALUMINIUM	340	5	75	5.8:1	10
CURADO K 301	VBS		✓	✓		ALU FRAME + HIGH STR RESIN	300	6	63	4.7:1	10
CURADO K 301 HG	VBS		✓	✓		ALU FRAME + HIGH STR RESIN	305	6	88	6.6:1	8
SLX 151	VBS			✓		ALU FRAME + HIGH STR RESIN	195	3	63	6.3:1	5
SLX 151 HG	VBS			✓		ALU FRAME + HIGH STR RESIN	195	3	72	7.2:1	5
SLX 151 XG	VBS			✓		ALU FRAME + HIGH STR RESIN	195	3	82	8.2:1	5
CAIUS A 151 LEFT	VBS					XT-7	210	3	76	7.2:1	5
GENPU XT 200 PG RIGHT						XT-7	195	3	59	5.5:1	5.5
GENPU XT 201 PG LEFT						XT-7	195	3	59	5.5:1	5.5

# REEL SPECIFICATIONS

MODEL	HAGANE GEAR	X-SHIP	HAGANE BODY	InfinityDrive	SILENTDRIVE	BODY MATERIAL	X-SHIELD	X-PROTECT	SPOOL MATERIAL /TYPE	HEAT SINK DRAG	WEIGHT (G)	BB QTY	LINE RETRIEVE PER CRANK(CM)	GEAR RATIO	DRAG TYPE	MAX DRAG FORCE (KG)	WATER PROOF DRAG
<b>HEAVY DUTY REELS</b>																	
STELLA SW C 4000 HG	✓	✓	✓	✓	✓	ALU	✓	✓	CF ALU (TI LIP)		355	12	93	5.7:1	TOUGH	11	✓
STELLA SW C 4000 XG	✓	✓	✓	✓	✓	ALU	✓	✓	CF ALU (TI LIP)		355	12	101	6.2:1	TOUGH	11	✓
STELLA SW C 5000 HG	✓	✓	✓	✓	✓	ALU	✓	✓	CF ALU (TI LIP)		420	13	97	5.7:1	TOUGH	13	✓
STELLA SW C 5000 XG	✓	✓	✓	✓	✓	ALU	✓	✓	CF ALU (TI LIP)		420	13	105	6.2:1	TOUGH	13	✓
STELLA SW C 6000 PG	✓	✓	✓	✓	✓	ALU	✓	✓	CF ALU (TI LIP)		425	13	83	4.7:1	TOUGH	13	✓
STELLA SW C 6000 HG	✓	✓	✓	✓	✓	ALU	✓	✓	CF ALU (TI LIP)		425	13	103	5.7:1	TOUGH	13	✓
STELLA SW C 6000 XG	✓	✓	✓	✓	✓	ALU	✓	✓	CF ALU (TI LIP)		425	13	112	6.2:1	TOUGH	13	✓
STELLA SW C 8000 HG	✓	✓	✓	✓	✓	ALU	✓	✓	CF ALU (TI LIP)		625	13	107	5.6:1	TOUGH	25	✓
STELLA SW C 8000 PG	✓	✓	✓	✓	✓	ALU	✓	✓	CF ALU (TI LIP)		625	13	94	4.9:1	TOUGH	25	✓
STELLA SW C 10000 PG	✓	✓	✓	✓	✓	ALU	✓	✓	CF ALU (TI LIP)	✓	670	13	102	4.9:1	TOUGH	25	✓
STELLA SW C 14000 XG	✓	✓	✓	✓	✓	ALU	✓	✓	CF ALU (TI LIP)	✓	675	13	134	6.2:1	TOUGH	25	✓
STELLA SW C 18000 HG	✓	✓	✓	✓	✓	ALU	✓	✓	CF ALU (TI LIP)	✓	875	13	129	5.7:1	TOUGH	25	✓
STELLA SW C 20000 PG	✓	✓	✓	✓	✓	ALU	✓	✓	CF ALU (TI LIP)	✓	885	13	104	4.4:1	TOUGH	25	✓
STELLA SW C 30000	✓	✓	✓	✓	✓	ALU	✓	✓	CF ALU (TI LIP)	✓	975	13	131	4.4:1	TOUGH	25	✓
TWINPOWER SW C 4000 XG	✓	✓	✓	✓	✓	ALU	✓	✓	CF ALU (TI COAT)		345	9	95	6.2:1	TOUGH	11	✓
TWINPOWER SW C 5000 HG	✓	✓	✓	✓	✓	ALU	✓	✓	CF ALU (TI COAT)		420	10	97	5.7:1	TOUGH	13	✓
TWINPOWER SW C 5000 XG	✓	✓	✓	✓	✓	ALU	✓	✓	CF ALU (TI COAT)		420	10	105	6.2:1	TOUGH	13	✓
TWINPOWER SW C 6000 HG	✓	✓	✓	✓	✓	ALU	✓	✓	CF ALU (TI COAT)		425	10	83	4.6:1	TOUGH	13	✓
TWINPOWER SW C 6000 XG	✓	✓	✓	✓	✓	ALU	✓	✓	CF ALU (TI COAT)		425	10	103	5.7:1	TOUGH	13	✓
TWINPOWER SW C 6000 XG	✓	✓	✓	✓	✓	ALU	✓	✓	CF ALU (TI COAT)		425	10	112	6.2:1	TOUGH	13	✓
TWINPOWER SW C 8000 PG	✓	✓	✓	✓	✓	ALU	✓	✓	CF ALU (TI COAT)		615	10	94	4.9:1	TOUGH	25	✓
TWINPOWER SW C 8000 HG	✓	✓	✓	✓	✓	ALU	✓	✓	CF ALU (TI COAT)		615	10	107	5.6:1	TOUGH	25	✓
TWINPOWER SW C 10000 PG	✓	✓	✓	✓	✓	ALU	✓	✓	CF ALU (TI COAT)	✓	655	10	102	4.9:1	TOUGH	25	✓
TWINPOWER SW C 10000 HG	✓	✓	✓	✓	✓	ALU	✓	✓	CF ALU (TI COAT)	✓	655	10	116	5.6:1	TOUGH	25	✓
TWINPOWER SW C 14000 XG	✓	✓	✓	✓	✓	ALU	✓	✓	CF ALU (TI COAT)	✓	660	10	134	6.2:1	TOUGH	25	✓
SARAGOSA SW A 5000 XG	✓	✓	✓	✓		ALU	✓	✓	CF ALU		450	5	105	6.2:1	FD	10	✓
SARAGOSA SW A 6000 HG	✓	✓	✓	✓		ALU	✓	✓	CF ALU		455	5	103	5.7:1	FD	10	✓
SARAGOSA SW A 8000 HG	✓	✓	✓	✓		ALU	✓	✓	CF ALU		675	5	107	5.6:1	FD	12.3	✓
SARAGOSA SW A 10000 PG	✓	✓	✓	✓		ALU	✓	✓	CF ALU		685	5	94	4.9:1	FD	15	✓
SARAGOSA SW A 14000 XG	✓	✓	✓	✓		ALU	✓	✓	CF ALU		710	5	135	6.2:1	FD	15	✓
SARAGOSA SW A 18000 HG	✓	✓	✓	✓		ALU	✓	✓	CF ALU		915	6	129	5.7:1	FD	22	✓
SARAGOSA SW A 20000 PG	✓	✓	✓	✓		ALU	✓	✓	CF ALU		945	6	104	4.4:1	FD	20	✓
SARAGOSA SW A 25000	✓	✓	✓	✓		ALU	✓	✓	CF ALU		970	6	103	4.4:1	FD	20	✓
SPHEROS SW A 5000 XG	✓	✓	✓	✓		ALU	✓	✓	CF ALU		445	4	105	6.2:1	FD	10	✓
SPHEROS SW A 6000 HG	✓	✓	✓	✓		ALU	✓	✓	CF ALU		450	4	103	5.7:1	FD	10	✓
SPHEROS SW A 6000 PG	✓	✓	✓	✓		ALU	✓	✓	CF ALU		450	4	83	4.6:1	FD	10	✓
SPHEROS SW A 8000 HG	✓	✓	✓	✓		ALU	✓	✓	CF ALU		665	4	107	5.6:1	FD	13	✓
SPHEROS SW A 10000 PG	✓	✓	✓	✓		ALU	✓	✓	CF ALU		675	4	102	4.9:1	FD	12	✓
SPHEROS SW A 14000 XG	✓	✓	✓	✓		ALU	✓	✓	CF ALU		680	4	134	6.2:1	FD	12	✓
SPHEROS SW A 18000 HG	✓	✓	✓	✓		ALU	✓	✓	CF ALU		920	4	129	5.7:1	FD	18	✓
SPHEROS SW A 20000 PG	✓	✓	✓	✓		ALU	✓	✓	CF ALU		930	4	104	4.4:1	FD	18	✓
SPHEROS SW C3000 HG	✓	✓	✓	✓		ALU	✓	✓	CF ALU		245	3	88	6.0:1	FD	9	✓
SPHEROS SW 3000 XG	✓	✓	✓	✓		ALU	✓	✓	CF ALU		255	3	91	6.2:1	FD	9	✓
SPHEROS SW 4000 XG	✓	✓	✓	✓		ALU	✓	✓	CF ALU		280	3	99	6.2:1	FD	11	✓
SOCORRO SW 5000	✓	✓				XT-7	✓	✓	CF ALU		440	4	78	4.6:1	FD	10	✓
SOCORRO SW 6000	✓	✓				XT-7	✓	✓	CF ALU		445	4	83	4.6:1	FD	10	✓
SOCORRO SW 8000	✓	✓				XT-7	✓	✓	CF ALU		640	4	94	4.9:1	FD	12	✓
SOCORRO SW 10000	✓	✓				XT-7	✓	✓	CF ALU		665	4	102	4.9:1	FD	12	✓

MODEL	BALL BEARING TYPE	SPOOL MATERIAL /TYPE	LEVEL WIND SYSTEM	X-SHIP	HAGANE BODY	BODY MATERIAL	WATER PROTECTION SYSTEM	E.I TREATMENT	WATERPROOF DRAG	WEIGHT (G)	BB QTY	LINE RETRIEVE PER WINCH	GEAR RATIO	MAXDRAG FORCE (KG)
<b>MULTIPLIER REELS</b>														
TIAGRA A 30LB	SHIELDED A-RB	CF ALU			✓	ALUMINIUM		✓	✓	1486	4	104/46	3.9:1/1:1.7	15
TIAGRA A 30LB WLRS	SHIELDED A-RB	CF ALU			✓	ALUMINIUM		✓	✓	1576	4	104/46	3.9:1/1:1.7	15
TIAGRA A 50LB WLRS	SHIELDED A-RB	CF ALU			✓	ALUMINIUM		✓	✓	2447	4	94/38	3.1:1/1:1.3	20
TIAGRA A 80LB W	SHIELDED A-RB	CF ALU			✓	ALUMINIUM		✓	✓	3266	4	94/48	2.5:1/1:1.3	24
TIAGRA A 130LB	SHIELDED A-RB	CF ALU			✓	ALUMINIUM		✓	✓	4936	6	99/56	2.1:1/1:1.1	40
TALICA 8LB	SHIELDED A-RB	DIECASTED ALU			✓	ALUMINIUM		✓	✓	450	6	97	6.2:1	9
TALICA 12LB	SHIELDED A-RB	DIECASTED ALU			✓	ALUMINIUM		✓	✓	655	6	104	5.7:1	18
TALICA 16LB	SHIELDED A-RB	DIECASTED ALU			✓	ALUMINIUM		✓	✓	669	6	104	5.7:1	18
TALICA II 16LB	SHIELDED A-RB	DIECASTED ALU			✓	ALUMINIUM		✓	✓	750	6	104/56	5.7:1/3:1:1	20
TALICA II 20LB	SHIELDED A-RB	DIECASTED ALU			✓	ALUMINIUM		✓	✓	920	6	104/56	5.2:1/3:1:1	20
TALICA II 25LB	SHIELDED A-RB	DIECASTED ALU			✓	ALUMINIUM		✓	✓	950	6	104/56	5.2:1/3:1:1	20
TALICA II 50LB	SHIELDED A-RB	DIECASTED ALU			✓	ALUMINIUM		✓	✓	1588	6	114/53	3.8:1/1:1.7:1	27
TYRNOS 16LB	A-RB	DURALUMINIUM			✓	ALUMINIUM			✓	819	4	115	5.0:1	15
TYRNOS 20LB	A-RB	DURALUMINIUM			✓	ALUMINIUM			✓	1021	4	115	5.0:1	15
TYRNOS 30LB	A-RB	DURALUMINIUM			✓	ALUMINIUM			✓	1080	4	115	5.0:1	15
TYRNOS II 20LB	A-RB	DURALUMINIUM			✓	ALUMINIUM			✓	1110	4	115/46	5.0:1/2.0:1	15



MODEL	BALL BEARING TYPE	SPOOL MATERIAL /TYPE	LEVEL WIND SYSTEM	X-SHIP	HAGANE BODY	BODY MATERIAL	WATER PROTECTION SYSTEM	E.I TREATMENT	WATERPROOF DRAG	WEIGHT (G)	BB QTY	LINE RETRIEVE PER WINCH	GEAR RATIO	MAXDRAG FORCE (KG)
<b>MULTIPLIER REELS</b>														
TYRNOS II 30LB	A-RB	DURALUMINIUM			✓	ALUMINIUM			✓	1160	4	115/46	5.0:1/2.0:1	15
TYRNOS II 50LB	A-RB	DURALUMINIUM			✓	ALUMINIUM			✓	1625	4	111/41	4.0:1/1.5:1	19
TLD 15LB	A-RB	DIECASTED ALU				XT-7			✓	527	4	76	4.0:1	10
TLD 20LB	A-RB	DIECASTED ALU				XT-7			✓	670	4	81	3.6:1	10
TLD 25LB	A-RB	DIECASTED ALU				XT-7			✓	695	4	81	3.6:1	10
TLD II A 30LB	A-RB	DIECASTED ALU				XT-7			✓	1064	4	94/41	4.0:1/1.7:1	15
TLD II A 50LB	A-RB	DIECASTED ALU				XT-7			✓	1624	4	97/38	3.5:1/1.4:1	17
SPEEDMASTER II 12LB	SHIELDED A-RB	DIECASTED ALU		✓		XT-7	COREPROTECT	✓	✓	730	4	107/58	5.7:1/3.1:1	18
SPEEDMASTER II 16LB	SHIELDED A-RB	DIECASTED ALU		✓		XT-7	COREPROTECT	✓	✓	750	4	107/58	5.7:1/3.1:1	18
SPEEDMASTER II 20LB	SHIELDED A-RB	DIECASTED ALU		✓		XT-7	COREPROTECT	✓	✓	980	4	131/58	5.2:1/2.3:1	20
SPEEDMASTER II 25LB	SHIELDED A-RB	DIECASTED ALU		✓		XT-7	COREPROTECT	✓	✓	1025	4	131/58	5.2:1/2.3:1	20
TR CHARTER SPECIAL 1000	A-RB	DIECASTED ALU	✓			XT-7			✓	465	4	66	5.2:1	15
TR CHARTER SPECIAL 2000	A-RB	DIECASTED ALU	✓			XT-7			✓	485	4	66	5.2:1	15
TR G 200	A-RB	DIECASTED ALU	✓			XT-7				374	1	64	4.3:1	6
OCEA JIGGER F CUSTOM 1500 HG	SHIELDED A-RB	CF ALU			✓	ALUMINIUM	X-PROTECT			430	8	98	6.4:1	7
OCEA JIGGER F CUSTOM 1501 HG	SHIELDED A-RB	CF ALU			✓	ALUMINIUM	X-PROTECT			430	8	98	6.4:1	7
OCEA JIGGER F CUSTOM 2000 NR	SHIELDED A-RB	CF ALU			✓	ALUMINIUM	X-PROTECT			605	8	117	6.2:1	10
OCEA JIGGER F CUSTOM 2001 NR	SHIELDED A-RB	CF ALU			✓	ALUMINIUM	X-PROTECT			605	8	117	6.2:1	10
OCEA JIGGER 2001 HG	SHIELDED A-RB	CF ALU			✓	ALUMINIUM	X-PROTECT			595	8	117	6.2:1	10
OCEA JIGGER 2001 PG	SHIELDED A-RB	CF ALU			✓	ALUMINIUM	X-PROTECT			595	8	96	5.1:1	10
TORIUM A 14LB HG	SHIELDED A-RB	CF ALU		✓	✓	ALUMINIUM		✓		425	3	97	6.3:1	15
TORIUM A 16LB HG	SHIELDED A-RB	CF ALU		✓	✓	ALUMINIUM		✓		535	3	117	6.2:1	11
TORIUM A 20LB HG	SHIELDED A-RB	CF ALU		✓	✓	ALUMINIUM		✓		545	3	117	6.2:1	11
TORIUM A 16LB HG LEFT	SHIELDED A-RB	CF ALU		✓	✓	ALUMINIUM		✓		535	3	117	6.2:1	11
TORIUM A 20LB HG LEFT	SHIELDED A-RB	CF ALU		✓	✓	ALUMINIUM		✓		545	3	117	6.2:1	11
TEKOTA A 301 LC FEET	SHIELDED A-RB	DIECASTED ALU	✓		✓	ALUMINIUM	COREPROTECT			340	3	89	6.6:1	9
TEKOTA A 401 HG LC FEET	SHIELDED A-RB	DIECASTED ALU	✓		✓	ALUMINIUM	COREPROTECT			340	3	89	6.6:1	11
TEKOTA A 500 HG LC METER	SHIELDED A-RB	DIECASTED ALU	✓		✓	ALUMINIUM	COREPROTECT			430	3	75	6.3:1	11
TEKOTA A 501 HG LC FEET	SHIELDED A-RB	DIECASTED ALU	✓		✓	ALUMINIUM	COREPROTECT			430	3	75	6.3:1	11
TEKOTA A 600 HG FEET	SHIELDED A-RB	DIECASTED ALU	✓		✓	ALUMINIUM	COREPROTECT			430	3	75	6.3:1	11
TEKOTA A 601 HG LC METER	SHIELDED A-RB	DIECASTED ALU	✓		✓	ALUMINIUM	COREPROTECT			450	3	75	6.3:1	11
<b>ELECTRIC REELS</b>														
BEASTMASTER 9000	SHIELDED A-RB	CF ALU			✓	ALUMINIUM				1515	14	88	3.1:1	25
FORCEMASTER 9000	SHIELDED A-RB	CF ALU			✓	ALUMINIUM				1515	3	88	3.1:1	25
PLAYS 4000	SHIELDED A-RB	CF ALU			✓	POWER ALU				1270	2	68	3.2:1	15
PLAYS 600	SHIELDED A-RB	CF ALU				XT-7				475	5	59	5.5:1	11

## LINE CAPACITIES

The table shows the recommended line diameters for mono and braid, and the spool capacities for each of the SHIMANO reel sizes.

SPOOL SIZE	SPOOL CAPACITY MONO (MM/M)	SPOOL CAPACITY POWER PRO (MM/M)
<b>FRONT DRAG</b>		
500	0,20-110	0,10-125/ 0,15-60
1000S	0,12-155/0,14-115/0,16-90	N/A
1000	0,18-170 / 0,20-140 / 0,25-90	0,15-85 / 0,19-75
C2000S	0,14-145 / 0,16-105 / 0,18-80	0,06-115 / 0,10-80
2500S	0,16-150 / 0,18-120 / 0,20-95	0,10-130 / 0,15-75
2500	0,18-290 / 0,20-240 / 0,25-160	0,15-140 / 0,19-135
C3000S	0,16-150 / 0,18-120 / 0,20-95	0,10-130 / 0,15-75
C3000M	0,20-190 / 0,25-125 / 0,30-85	0,15-140 / 0,19-100
C3000	0,25-210 / 0,30-130 / 0,35-100	0,15-185 / 0,23-130
4000M	0,25-165 / 0,30-120 / 0,35-80	0,15-180 / 0,28-100
4000	0,25-260 / 0,30-180 / 0,35-130	0,19-210 / 0,28-165
C5000	0,30-240 / 0,35-175 / 0,40-120	0,23-240 / 0,32-170
6000	0,30-270 / 0,35-240 / 0,40-140	N/A
10000	0,30-510 / 0,35-380 / 0,40-260	N/A
<b>REAR DRAG</b>		
1000	0,18-170 / 0,20-140 / 0,25-90	0,15-85 / 0,19-75
2500	0,18-290 / 0,20-240 / 0,25-160	0,15-140 / 0,19-135
3000SS	0,14-200 / 0,16-170 / 0,18-130	N/A
3000S	0,18-240 / 0,20-220 / 0,25-140	N/A
4000S	0,18-240 / 0,20-220 / 0,25-140	N/A
4000	0,25-260 / 0,30-180 / 0,35-130	0,19-210 / 0,28-165
C3000S	0,16-150 / 0,20-95	0,10-130 / 0,15-75
C3000M	0,20-190 / 0,30-85	0,15-140 / 0,19-100
<b>BIG PIT</b>		
3500	0,20-200	N/A
5500	0,30-390 / 0,35-290 / 0,40-210	0,28-330 / 0,32-245
10000	0,35-400 / 0,40-300 / 0,45-200	N/A
14000	0,35-550 / 0,40-400 / 0,45-300	0,32-505 / 0,41-305

SPOOL SIZE	SPOOL CAPACITY MONO (MM/M)	SPOOL CAPACITY POWER PRO (MM/M)
<b>BAITRUNNER</b>		
2500	0,20-240/0,25-160/0,30-110	0,15-140 / 0,19-135
4000	0,25-260/0,30-180/0,35-130	0,19-210 / 0,28-165
6000	0,30-320/0,35-240/0,40-170	0,28-225 / 0,41-120
8000	0,30-390/0,35-290/0,40-200	0,32-270 / 0,41-165
10000	0,30-510/0,35-380/0,40-260	N/A
12000	0,35-500/0,40-320/0,45-240	0,36-460 / 0,43-210
MEDIUM	0,30-390/0,35-290/0,40-210	0,28-330 / 0,32-245
BIG	0,35-550/0,40-400/0,45-300	0,32-505 / 0,41-305
<b>SALTWATER SPINNING</b>		
4000	0,25-260 / 0,30-180 / 0,35-130	0,19-210 / 0,28-165
5000	0,330-200 / 0,370-150 / 0,405-130	0,23-225 / 0,28-205
6000	0,330-240 / 0,370-190 / 0,405-160	0,28-265 / 0,36-180
8000	0,370-275 / 0,405-230 / 0,470-160	0,32-310 / 0,36-265
10000	0,405-300 / 0,470-210 / 0,520-160	0,36-330 / 0,41-265
14000	0,405-330 / 0,470-240 / 0,520-195	0,36-365 / 0,41-290
18000	0,520-310 / 0,570-240 / 0,620-200	0,36-550 / 0,43-330
20000	0,520-350 / 0,620-240 / 0,700-190	0,41-450 / 0,43-365
25000	0,520-420 / 0,620-285 / 0,700-225	0,41-675 / 0,46-400
30000	0,620-400 / 0,700-300 / 0,740-270	0,41-825 / 0,46-520
<b>BAITCASTING</b>		
BFS	0,23-50	0,19-45
50/51	0,25-100	0,23-75 / 0,28-70
70/71	0,285-100	0,23-105 / 0,28-95
100/101	0,25-150	0,23-110 / 0,28-100
150/151	0,33-100	0,23-140 / 0,28-125
200/201	0,20-225 / 0,25-185 / 0,30-150	0,28-175 / 0,36-110
300/301	0,30-235	0,32-180 / 0,36-175
400/401	0,35-270	0,36-255 / 0,41-155



## BLANK TECHNOLOGY



### SPIRAL X CORE

SHIMANO's unique and patented SPIRAL X CORE construction consists of three layers: a first layer of carbon tape that spirals tightly around the blank in a diagonal direction, a middle sheet of carbon made out of vertical fibres and an outer layer comprising carbon tape that tightly spirals the blank in the opposite direction to the first layer. By using carbon tape, instead of a conventional horizontal fibre sheet, SPIRAL X enhances torsional rigidity without adding extra weight. SPIRAL X CORE makes use of the same construction as SPIRAL X, with the addition of a Nano resin distribution technology in the carbon tape. Nano resin technology distributes the resin more evenly through the carbon fibres resulting in a stronger, lighter rod. SPIRAL X CORE has 1.4 times better anti-twist capabilities and 2.5 times more compression rigidity compared to SPIRAL X.

#### BENEFIT

SPIRAL X CORE construction overcomes blank twist and increases rod strength, whilst keeping the weight low, for enhanced performance. It also minimizes the 'spine' which naturally occurs when using conventional sheet carbon material resulting in purer action. The result is improved casting accuracy, more powerful transmission, increased control of the lure, and improved fish-playing performance.



### SPIRAL X

SHIMANO's unique and patented SPIRAL X construction consists of three layers: a first layer of carbon tape that spirals tightly around the blank in a diagonal direction, a middle sheet of carbon made out of vertical fibres and an outer layer comprising carbon tape that tightly spirals the blank in the opposite direction to the first layer. By using carbon tape, instead of a conventional horizontal fibre sheet, SPIRAL X enhances torsional rigidity without adding extra weight. This construction results in less overlapping of material, which would normally result in a spine and weak spots.

#### BENEFIT

SPIRAL X construction overcomes blank twist and increases rod strength, whilst keeping the weight low, for enhanced performance. The result is improved casting accuracy, more power transmission, increased control of the lure, and improved fish-playing performance.



### HI-POWER X

SHIMANO's HI-POWER X construction, uses different carbon layers to create the blank. The outermost layer of carbon tape is diagonally wrapped in opposite directions, which forms an array of "X" shapes. The width of the tape, its winding angle and the part of the rod being wrapped are finely-tuned according to the rods intended use. The flexibility allows SHIMANO to adjust these wraps during construction for precise actions, enhanced overall strength and increased twist resistance. In short, HI-POWER X construction delivers sharp and crisp rod control.

#### BENEFIT

SHIMANO's HI-POWER X construction eliminates twist in the blank, which helps deliver more accuracy when casting and have more control when playing fish.



### NANOPITCH

With NANOPITCH manufacturing technology SHIMANO wraps a compression tape, with high precision, over the carbon blank before the curing (heating) process. The NANOPITCH method enables the carbon on the mandrel to be compressed extremely firmly, with uniform pressure, creating circularity pressure which contributes greatly to overall rod strength. NANOPITCH is always applied in combination with the SPIRAL X CORE blank construction to maximize rod performance.

#### BENEFIT

NANOPITCH results in higher roundness, which greatly contributes to higher strength. The fine pitch of the tape creates a high-quality exterior design.



**HIGH PRESSURE CARBON**

SHIMANO HIGH PRESSURE CARBON (HPC) is a process which creates stronger, more responsive blanks. Pressure is applied with a compression tape to the blank surface before curing (heating), which evenly distributes the resin through the carbon fibre matrix.

**BENEFIT**

SHIMANO'S HPC results in much stronger rods with more consistent performance and improved responsiveness.

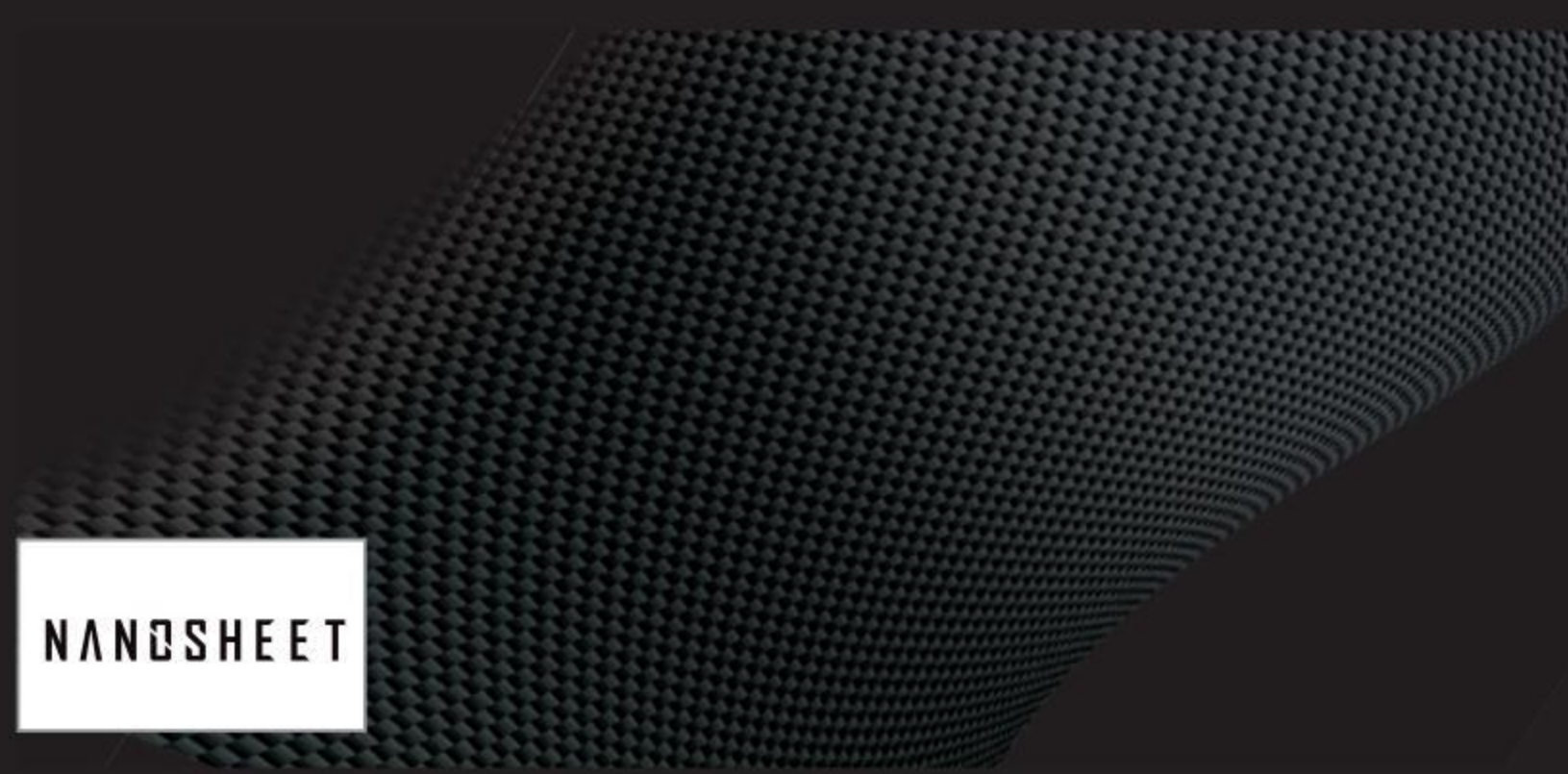

**NANOSHEET**

**NANOSHEET**

NANOSHEET is a multiple carbon sheet construction, which incorporates Nano resin distribution technology. The resin, which holds the different carbon fibres together, is distributed more evenly across the carbon fibres, resulting in a stronger and more light weight rod, with less potential defects and weak spots.

**BENEFIT**

SHIMANO'S NANOSHEET technology results in increased overall rod strength and weight reduction. It also increases strength and improves feel.



**BIOFIBRE**

SHIMANO'S unique BIOFIBRE construction improves overall rod strength and resistance to shock whilst producing increased lifting power in the tip.

**BENEFIT**

SHIMANO'S BIOFIBRE technology gives excellent control over hard fighting fish and enables more power to be exerted.



**GEOFIBRE**

GEOFIBRE is a naturally derived component that provides rigidity and high tensile strength when added to rods in the lower to mid-price rod band.

**BENEFIT**

The GEOFIBRE material produces stronger rods in the lower to mid-price segment that are more resistant to breakages.



**DIAFLASH**

With SHIMANO'S DIAFLASH construction, the outermost layer of the butt section is diagonally wrapped in opposite directions with carbon tape, which forms an array of "X" shapes. The width of the tape, its winding angle and the part of the rod being wrapped are fine-tuned according to the rods intended use. DIAFLASH is a reinforced structure that prevents twisting of the butt section in situations where high-intensity pressure is applied.

**BENEFIT**

SHIMANO'S DIAFLASH construction improves the pulling power of the rod, whilst minimizing the loss of energy through excess flexing of the butt section.



**TWIST CONTROL**

An anti-twist blank construction process which is applied to Big Game saltwater rods.

**BENEFIT**

When fighting huge fish with Big Game saltwater rods, TWIST CONTROL enables more power to be directly applied to the fish.



**MUSCLE CARBON**

MUSCLE CARBON is a high-performance material that reduces the gaps between fibres, by bundling carbon filaments together at a higher density than traditional carbon sheet. This reduces the amount of resin need to fill the gaps in the carbon matrix during the curing process.

**BENEFIT**

The MUSCLE CARBON material enables lightweight blanks without losing blank strength.



**MUSCLE LOOP**

MUSCLE LOOP is formed using a spiral carbon tape, wrapped on the outside of the blank, which reduces the natural 'spine' of the blank and also improves strength. This helps prevent the blank from distorting under extreme pressure.

**BENEFIT**

The MUSCLE LOOP construction reduces the spine, improves overall rod strength compared to conventionally made blanks, and increases control over hard fighting fish.

## GRIP TECHNOLOGY



### FULL CARBON MONOCOQUE

The FULL CARBON MONOCOQUE grip is an evolution of the Carbon Monocoque grip and features up to 28% increased sensitivity. Normally the grip section, behind the reel seat is made of EVA or cork, however with the Full Carbon Monocoque grip this section is also moulded from a hollow carbon structure. This greatly improves the lightness and ability to detect vibrations transmitted to the hand. In addition, the carbon grip section is cushioned to prevent slipping with the hand.

#### BENEFIT

The FULL CARBON MONOCOQUE grip with ergonomic design is extremely lightweight and sensitive. When lure fishing, it is very important to have excellent transfer of vibration from the rod to the hand. This enables increased feeling of different types of bottom structures and magnifies tentative bites. It also offers stability when fighting with a fish and better control of the lure.



### CARBON MONOCOQUE

The CARBON MONOCOQUE grip is a one-piece hollow carbon construction, which is integrated seamlessly into the rod blank. The remarkably lightweight handle is stiffer than traditional rod construction, reduces the overall weight of the rod and also increases vibration transmission.

#### BENEFIT

The CARBON MONOCOQUE grip reduces overall weight of the rod and increases vibration transmission to the hand. When used in combination with braided mainlines, the increased sensitivity of the handle enables bottom structures to be identified and tentative takes to be felt with more assurance.

## REAL SEAT

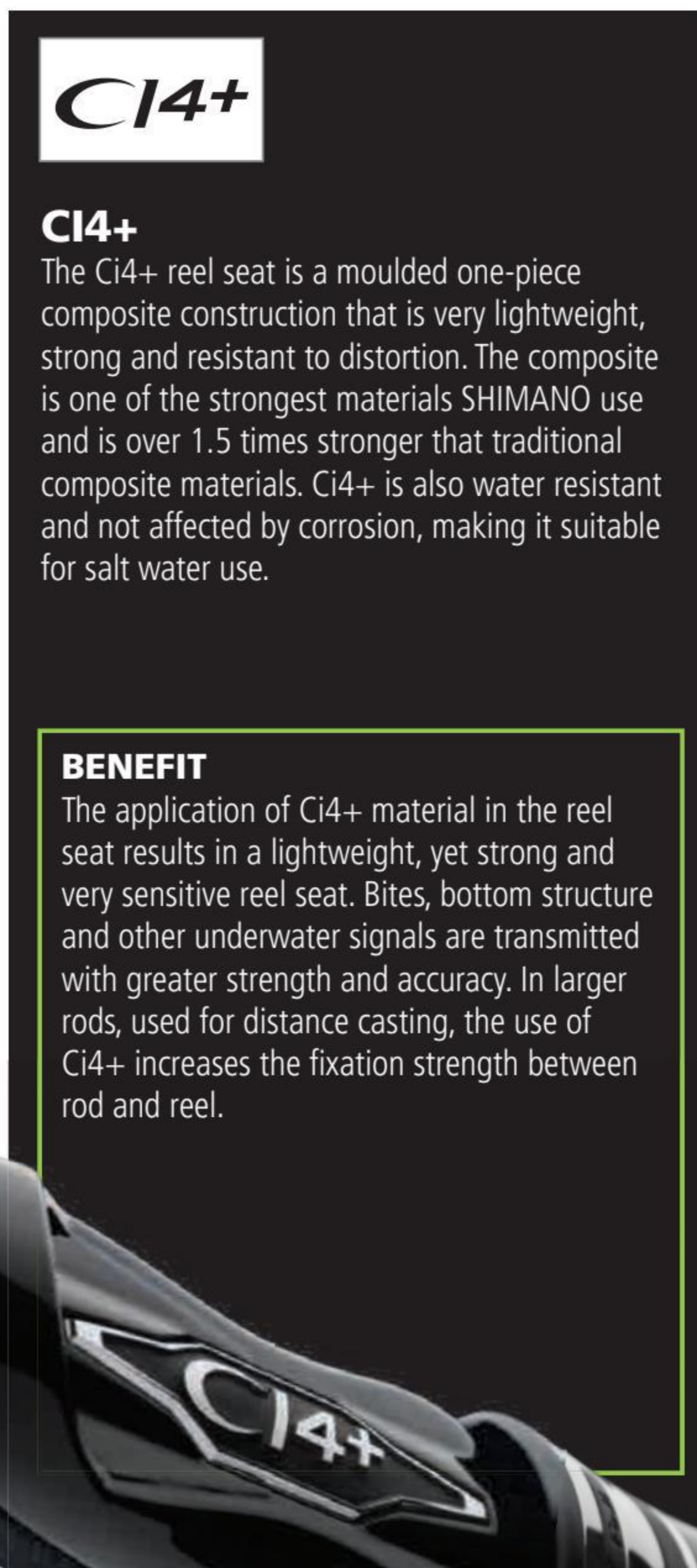

### CI4+

The Ci4+ reel seat is a moulded one-piece composite construction that is very lightweight, strong and resistant to distortion. The composite is one of the strongest materials SHIMANO use and is over 1.5 times stronger than traditional composite materials. Ci4+ is also water resistant and not affected by corrosion, making it suitable for salt water use.

#### BENEFIT

The application of Ci4+ material in the reel seat results in a lightweight, yet strong and very sensitive reel seat. Bites, bottom structure and other underwater signals are transmitted with greater strength and accuracy. In larger rods, used for distance casting, the use of Ci4+ increases the fixation strength between rod and reel.

## TIP SECTION TECHNOLOGY



### TAFTEC ALPHA

TAFTEC ALPHA tips utilise a pre-stretched T-3500 directional yarn fibre with low resin saturation. This directional alignment of the fibres in the solid tip results in much less damage during the grinding process and results in a spineless construction. In tests it has been shown to be much stronger, lower in weight, faster in action and more sensitive.

#### BENEFIT

TAFTEC ALPHA tips enable rod tips to be made thinner and more sensitive which is especially useful when finesse fishing. Bites are maximised and fish feel less tension when inhaling the lure, resulting in more hook-ups.



### SOFTUBE TOP

The SOFTUBE TOP provides the sensitivity of an ultra fine solid carbon tip with the lightness of a hollow/tubular tip construction. This tip construction can be found on models where sensitivity and finesse are both important requirements.



### EXCITE TOP

EXCITE TOP is a special tip that enhances the shake performance of lures and contributes to sensitivity. The tip section is tapered and slightly heavier at the top. This construction expands the swing width of the tip, enabling shaking with an automatic feeling. The movement seen by the eyes, and the sensitivity transmitted to the hands, is greatly improved.

#### BENEFIT

The EXCITE TOP has a specially tapered tip section which allows anglers to easily present lures with a shaking action. In some situations, especially when fishing for reluctant fish, this approach can trigger more bites.

#### BENEFIT

The smooth, seamless action of the SOFTTUBE TOP offers the angler better bite detection, close to that of a solid tip.

# ROD ACTIONS

SHIMANO takes great care when developing rods and designing the correct actions to suit the intended use. As a general guide, Extra-Fast and Fast actions offer more sensitivity and hooking speed, plus the ability to cast further with heavy loading. Moderate-Fast and Moderate actions offer more flexibility and confidence when playing fish as the action absorbs increased pressure smoothly. Moderate actions are also good for casting very light loading as the rod 'works' through its length to create tip speed.

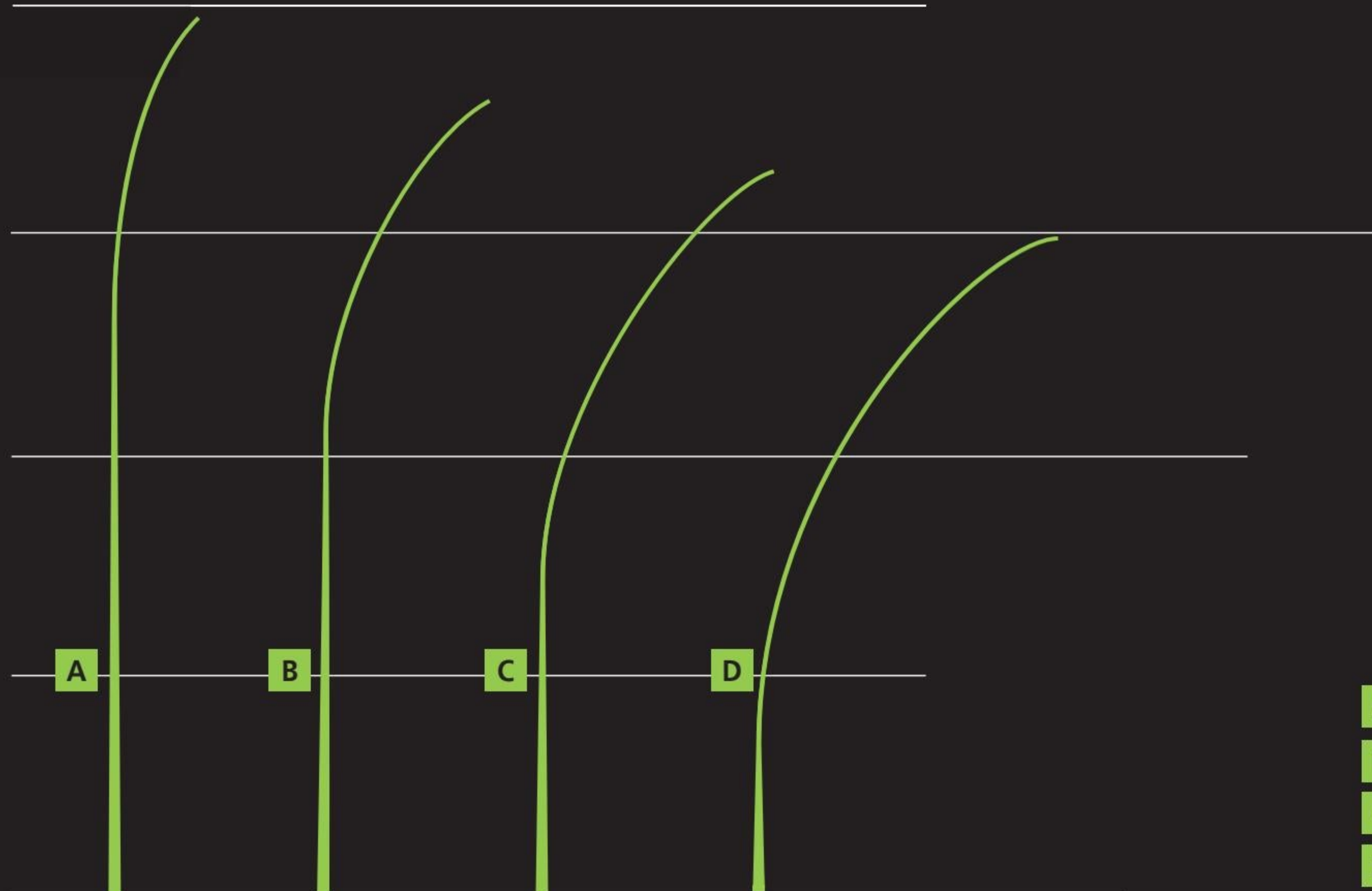

- A EXTRA-FAST ACTION**
- B FAST ACTION**
- C MODERATE-FAST ACTION**
- D MODERATE ACTION**

## EXTRA-FAST ACTION

A very light and sensitive tip facilitates an effective transfer of energy resulting in effortless pin-point casts, near or far. This action will make any angler a more effective caster.

## FAST ACTION

Fast action rods have a light tip that transfers into the power quickly for positive hook sets and effortless repetitive casting. If you are looking for a lure rod to do it all, a fast action rod is a solid choice.

## MODERATE-FAST ACTION

The deeper flex associated with this action allows the angler to control the energy of the fish with additional confidence. This action offers an unsurpassable ability to land the majority of fish hooked on the lightest tackle.

## MODERATE ACTION

Whenever an angler needs the perfect action to absorb the surging power of a fish delivering aggressive headshakes or quick runs, a moderate action rod neutralizes their power.

## ROD SPECIFICATION EXPLANATION

Product Code	Length (m)	Transport Length (cm)	Number of Sections	Weight (g)	Casting Weight (g)	Line Rating (lb)	Test Curve	Jig Weight (g)
18PADRN264UL	1.93m	193cm	1	85g	2-7g	20-30lb	2.00	150g
18PADRN267ML	2.01m	201cm	1	92g	4-12g	25-40lb	2.00	150g

### PRODUCT CODE

The product code is used by all SHIMANO dealers to identify the model.

### LENGTH (M)

This length indicates the length of the rod when it is fully assembled.

### TRANSPORT LENGTH (CM)

This transport length indicates the length when the rod is not assembled

### NUMBER OF SECTIONS

The number of sections indicates how many sections the rod has.

### WEIGHT (G)

The weight indicates the weight of the rod in grams.

### CASTING WEIGHT (G)

The casting weight indicates the optimum casting weight for the rod to perform correctly.

### LINE RATING (LB)

For saltwater rods the line rating is shown in lbs.

### TEST CURVE

For specimen rods the test curve is shown in lbs.

### JIG WEIGHT (G)

For jigging rods the ideal jigging weight is shown in grams.



# FRESHWATER PREDATOR RODS

SHIMANO freshwater predator rods cover a wide variety of budgets and requirements, from the high-end Yasei LTD models which are custom designed for specific species and techniques to the remarkably inexpensive FX which offers fantastic value and choice for the inexperienced or younger angler.

For fans of Japanese designed rods, a range of hand-selected JDM models is available, including the world-renowned Poison Adrena.

## TECHNIQUE SPECIFIC JDM

120	POISON ADRENA	<b>NEW MODELS</b>
122	EXPRIDE	<b>NEW</b>
124	ZODIAS	
126	CURADO	<b>NEW</b>
127	BASS ONE XT	

## TECHNIQUE SPECIFIC EU

130	YASEI LTD	
132	YASEI	
136	YASEI BB	

## VERSATILE SPINNING

141	SUSTAIN	<b>NEW</b>
142	NORDEN · TECHNIUM AX	
143	BEASTMASTER · FX SEDONA	
144	NASCI	<b>NEW</b>
146	NEXAVE	<b>NEW</b>
148	CATANA · CATANA TELE	<b>NEW</b>
150	VENGEANCE CX · FX XT	

## SUPER SENSITIVE

151	ZODIAS SUPER SENSITIVE	
	VENGEANCE CX SENSITIVE	

## ICE RODS

152	SEDONA ICE · SIENNA ICE	<b>NEW</b>
-----	-------------------------	------------



# JDM

## HIGH-END JAPANESE DOMESTIC MODELS

To satisfy the demand of anglers looking for high quality, precision engineered tackle, designed for the very latest techniques, the SHIMANO JDM range offers outstanding products. These have been designed and manufactured without compromise, originally for the high-end Japanese market, but now available to anglers throughout Europe.





# HIGH-END JAPANESE DESIGN

NEW MODELS

## POISON ADRENA SPINNING / CASTING

- Ultimate high-end Japanese design and construction
- High modulus carbon blank with Spiral X Core and Nanopitch for increased strength and sensitivity
- Full Carbon Monocoque handle increases sensitivity by up to 140%
- Improved ergonomic Ci4+ reel seat (Perfextion Seat XT)
- Fuji Stainless Steel SiC-S K-Type plus Stainless Steel SiC tip guide
- Available in both spinning and baitcasting options to suit anglers preference of reel and technique



SPINNING

18PADRN264UL	1.93m	193cm	1	85g	2-7g
18PADRN266L2	1.98m	102cm	2	85g	3-10g
18PADRN267ML	2.01m	201cm	1	92g	4-12g
18PADRN276M2	2.29m	118cm	2	102g	5-15g

CASTING

18PADRN163M	1.91m	191cm	1	95g	7-21g
18PADRN166MH	1.98m	198cm	1	102g	10-30g
18PADRN169XHSB2	2.06m	107cm	2	130g	150g <b>NEW</b>
18PADRN1610M	2.08m	208cm	1	105g	7-21g
18PADRN172H	2.18m	186cm	2 (SH)*	122g	12-42g
18PADRN173MH2	2.21m	113cm	2	117g	10-30g <b>NEW</b>







## SEARCH YOUR PERFECT MATCH...

This chart shows which kind of lure is most suited to each model of the Poison Adrena Spinning and Casting range. The stars indicate the rating based on 'Excellent', 'Great' and 'Good'.

★★★ = Excellent  
★★ = Great  
★ = Good

MODEL	SUITABLE LURE WEIGHT (g)	TEXAS RIG	LIGHT TEXAS RIG	HEAVY DROPSHOT	DROPSHOT	RUBBER JIG	SMALL RUBBER JIG	JIG HEAD RIG	JIG HEAD WACKY	NEKO RIG	WEIGHTLESS RIG	SPLIT SHOT RIG	CAROLINA RIG	CRANKBAIT	LIPLESS CRANKBAIT	MINNOW / JERKBAIT	SHAD BAIT	TOP WATER	SPINNER BAIT	SWIM & BIG BAITS	FROG	
<b>POISON ADRENA SPINNING</b>		<b>SUITABLE PLASTIC WORM &amp; JIG</b>										<b>SUITABLE WOBBLER</b>										
18PADRN264UL	2-7g				★★★		★★★	★★★	★★★	★★★	★★★	★				★★	★★					
18PADRN266L2	3-10g		★		★★★		★★★	★★★	★★★	★★★	★★★	★★★	★	★	★	★★★	★★★	★				
18PADRN267ML	4-12g		★★	★	★		★★	★★	★	★	★★	★★★	★★★	★	★	★★★	★★★	★★	★★			
18PADRN276M2	5-15g	★★	★	★★★	★		★	★★★	★★	★★	★★	★★★	★★★		★★★	★★	★★★	★★★	★★	★★		★
<b>POISON ADRENA CASTING</b>		<b>SUITABLE PLASTIC WORM &amp; JIG</b>										<b>SUITABLE WOBBLER</b>										
18PADRN163M	7-21g	★★	★★	★★★	★	★★		★★		★	★	★★		★★	★★★	★★★	★★	★★★	★★★			
18PADRN166MH	10-30g	★★★	★	★★		★★★									★			★	★★			
18PADRN169XHSB2	150g					★							★		★★★			★★★	★★★	★★★	★★★	★★★
18PADRN1610M	7-21g	★★	★★	★★	★	★★				★	★			★★★	★★★	★★★	★★★	★★★	★★★			
18PADRN172H	12-42g	★★★	★	★		★★★						★	★★★		★				★★	★★	★★	★★★
18PADRN173MH2	10-30g	★★	★			★★★							★★★	★	★★			★★	★★★	★		



# EXUDES QUALITY

NEW

## EXPRIDE SPINNING / CASTING

- Lightweight, responsive High Modulus Full Carbon Hi-Power X blanks
- Ultra lightweight SHIMANO Ci4+ custom reel seat for superb balance
- Fuji Stainless Steel guides with SiC linings for mono and braid lines
- Carbon Monocoque handle with cork grip for extreme sensitivity
- Available in 1+1 and 2 section Spinning and Baitcasting configurations



### SPINNING

22EXP264UL	1.93m	166cm	2 (SH)*	85g	2-7g
22EXP2610ML	2.08m	179cm	2 (SH)*	90g	4-12g
22EXP270MHP	2.13m	183cm	2 (SH)*	100g	7-30g
22EXP264UL2	1.93m	100cm	2	87g	2-7g
22EXP266L2	1.98m	102cm	2	92g	3-10g
22EXP2610ML2	2.08m	107cm	2	92g	4-12g
22EXP272MH2	2.18m	112cm	2	105g	7-21g

### CASTING

22EXP163LBFS	1.91m	164cm	2 (SH)*	90g	3.5-10g
22EXP1610M	2.08m	177cm	2 (SH)*	100g	7-21g
22EXP172MH	2.18m	187cm	2 (SH)*	122g	10-30g
22EXP172H	2.18m	186cm	2 (SH)*	120g	14-42g
22EXP163LBFS2	1.91m	99cm	2	90g	3.5-10g
22EXP1610M2	2.08m	107cm	2	100g	7-21g
22EXP172MH2	2.18m	112cm	2	117g	10-30g
22EXP172H2	2.18m	112cm	2	120g	14-42g





## SEARCH YOUR PERFECT MATCH...

This chart shows which kind of lure is most suited to each model of the Exprise Spinning and Casting range. The stars indicate the rating based on 'Excellent', 'Great' and 'Good'.

★★★ = Excellent  
★★ = Great  
★ = Good

MODEL	SUITABLE LURE WEIGHT (G)	TEXAS RIG	LIGHT TEXAS RIG	HEAVY DROPSHOT	DROPSHOT	RUBBER JIG	SMALL RUBBER JIG	JIG HEAD RIG	JIG HEAD WACKY	NEKO RIG	WEIGHTLESS RIG	DROPSHOT RIG	CAROLINA RIG	FREE RIG	CRANKBAIT	LIPLESS CRANKBAIT	MINNOW / JERKBAIT	SHAD BAIT	TOP WATER	SPINNER BAIT	SWIM & BIG BAITS	FROG
<b>EXPRIDE SPINNING</b>																						
22EXP264UL	2-7g				★★★		★★★	★	★★★	★★★	★★★	★★					★★★	★★★				
22EXP2610ML	4-12g		★★	★	★★	★	★★	★	★★★	★★★	★★★	★★★	★★★		★	★	★★★	★★★	★	★		★
22EXP270MHP	7-30g	★★	★★★	★★★	★★	★★	★★★	★★	★★	★★★	★★★	★★	★★★						★	★		★★★
22EXP264UL2	2-7g				★★★		★★★	★	★★★	★★★	★★★	★★					★★★	★★★				
22EXP266L2	3-10g		★		★★		★★★	★	★★★	★★★	★★★	★★★			★	★	★★★	★★★	★			
22EXP2610ML2	4-12g		★★	★	★★	★	★★	★	★★★	★★★	★★★	★★★	★★★		★	★	★★★	★★★	★	★		★
22EXP272MH2	7-21g	★★	★★★	★★★	★★	★★	★★★	★★	★★	★★★	★★★	★★	★★★						★	★		★★★
<b>EXPRIDE CASTING</b>																						
22EXP163LBFS	3.5-10g		★★		★★★		★★★	★	★★★	★★★	★★★	★		★	★	★	★★	★★	★	★		
22EXP1610M	7-21g	★★	★★	★★	★	★				★★	★★			★	★★	★★★	★★★	★★	★★★	★★★		
22EXP172MH	10-30g	★★★	★	★		★★★							★★★	★	★	★★	★			★★★	★★	★
22EXP172H	14-42g	★★★	★	★★		★★★					★		★★★			★				★	★★	★★
22EXP163LBFS2	3.5-10g		★★		★★★		★★★	★	★★★	★★★	★★★	★		★	★	★	★★	★★	★	★		
22EXP1610M2	7-21g	★★	★★	★★	★	★				★★	★★			★	★★	★★★	★★★	★★	★★★	★★★		
22EXP172MH2	10-30g	★★★	★	★		★★★							★★★	★	★	★★	★		★★	★★★	★★	★
22EXP172H2	14-42g	★★★	★	★★		★★★					★		★★★			★				★	★★	★★

# FAST & EXTRA FAST ACTIONS



## ZODIAS

### SPINNING / CASTING

- Strong, lightweight Hi-Power X blank construction designed and developed in Japan
- Custom designed fast and extra fast rod actions depending on model
- Carbon Monocoque rear grip for extreme sensitivity
- Custom Ci4+ reel seat for secure reel support
- Fuji Alconite guides with Fuji SiC top guide on Baitcasting models
- Fuji Alconite K type guides on spinning models
- Taftec Alpha solid tip on ULS2 Spinning model
- NEW Zodias super sensitive models, for ultra light applications, on page 151



#### SPINNING

20ZODIAS264ULS2	1.93m	101.5cm	2	90g	1.5-5g
20ZODIAS264UL2	1.93m	101.5cm	2	92g	2-7g
20ZODIAS268L2	2.03m	106.5cm	2	95g	3-10g
20ZODIAS268ML2	2.03m	106.5cm	2	97g	4-12g
20ZODIAS270M2	2.13m	111.5cm	2	107g	5-15g
20ZODIAS270MH2	2.13m	110cm	2	112g	7-21g
20ZODIAS270H2	2.13m	179cm	2 (SH)*	120g	10-30g

#### CASTING

20ZODIAS168LBF	2.03m	175cm	2 (SH)*	97g	4-12g
20ZODIAS1610M	2.08m	179cm	2 (SH)*	110g	7-21g
20ZODIAS172H	2.18m	185cm	2 (SH)*	127g	12-42g
20ZODIAS164LBF2	1.93m	101.5cm	2	92g	4-12g
20ZODIAS1610M2	2.08m	109cm	2	107g	7-21g
20ZODIAS172H2	2.18m	114cm	2	130g	12-42g





## SEARCH YOUR PERFECT MATCH...

This chart shows which kind of lure is most suited to each model of the Zodiacs Spinning and Casting range. The stars indicate the rating based on 'Excellent', 'Great' and 'Good'.

★★★ = Excellent  
★★ = Great  
★ = Good

MODEL	SUITABLE LURE WEIGHT (g)	TEXAS RIG	LIGHT TEXAS RIG	HEAVY DROPSHOT	DROPSHOT	RUBBER JIG	SMALL RUBBER JIG	JIG HEAD RIG	JIG HEAD WACKY	NEKO RIG	WEIGHTLESS RIG	SPLIT SHOT RIG	CAROLINA RIG	CRANKBAIT	LIPLESS CRANKBAIT	MINNOW / JERKBAIT	SHAD BAIT	TOP WATER	SPINNER BAIT	SWIM & BIG BAITS	FROG	
<b>ZODIAS SPINNING</b>		<b>SUITABLE PLASTIC WORM &amp; JIG</b>											<b>SUITABLE WOBBLER</b>									
20ZODIAS264UL-S/2	1.5-5g				★★★		★★★	★★	★★★	★★★	★★★	★				★	★					
20ZODIAS264UL-2	2-7g			★★★			★★★	★★★	★★★	★★★	★★★	★		★	★	★★	★★	★				
20ZODIAS268L-2	3-10g		★		★★		★★★	★★★	★★★	★★★	★★★	★★★	★★	★	★	★★★	★★★	★				
20ZODIAS268ML-2	4-12g		★★	★	★★	★	★★	★★★	★★★	★★★	★★★	★★★	★★★	★	★	★★★	★★★	★	★			
20ZODIAS270M-2	5-15g	★	★★	★★★	★★	★	★★★	★★★	★★★	★★★	★★★	★★★	★★★		★★	★★★	★★	★	★			★
20ZODIAS270MH2	7-21g	★		★★★	★★	★★★	★★	★★★	★★	★★	★	★★	★★	★★	★★	★★★	★★	★	★			★
20ZODIAS270H2	10-30g	★		★★★		★★★		★★★						★★	★★	★★★	★★★	★★	★★			★★
<b>ZODIAS CASTING</b>		<b>SUITABLE PLASTIC WORM &amp; JIG</b>											<b>SUITABLE WOBBLER</b>									
20ZODIAS168L-BFS	4-12g		★★	★	★★★		★★★	★★	★★★	★★★	★★★	★★		★★	★★	★★	★★	★	★			
20ZODIAS1610M	7-21g	★★	★★	★★	★	★★				★	★			★★	★★★	★★★	★★	★★★	★★★			
20ZODIAS172H	12-42g	★★★	★	★		★★★							★★★	★	★★			★	★★★	★		★★
20ZODIAS164L-BFS/2	4-12g		★★	★	★★★		★★★		★★★	★★★	★★★	★		★★	★★	★★	★★	★	★			
20ZODIAS1610M-2	7-21g	★★	★★	★★	★	★★				★	★			★★	★★★	★★★	★★	★★★	★★★			
20ZODIAS172H-2	12-42g	★★★	★	★		★★★							★★★	★	★★			★	★★★	★		★★

# JDM RODS



## NEW MODELS

# CURADO

## SPINNING / CASTING

- Lightweight Full Carbon Hi-Power X blanks
- Available in both Casting and Spinning models
- SHIMANO Ci4+ custom reel seat
- Fuji Stainless Steel guides with Fazlite linings
- Split EVA grips
- Graphics and colour match the CURADO Baitcasting reel



	Length	Tip Length	Sections	Weight	Range	
<b>SPINNING</b>						
CDS70LEUA	2.13m	213cm	1	102g	2-10g	
CDS70MLEUA	2.13m	213cm	1	105g	4-12g	
CDS70MEUA	2.13m	213cm	1	105g	5-15g	
CDS70L2EUA	2.13m	110cm	2	-	2-10g	<b>NEW</b>
CDS70ML2EUA	2.13m	110cm	2	-	4-12g	<b>NEW</b>
CDS70M2EUA	2.13m	111cm	2	-	5-15g	<b>NEW</b>
CDS72MH2EUA	2.18m	123cm	2	-	7-21g	<b>NEW</b>
<b>CASTING</b>						
CDC610MEUA	2.08m	208cm	1	110g	7-21g	
CDC72MLBF5EUA	2.18m	218cm	1	115g	5-15g	
CDC72MHEUA	2.18m	218cm	1	120g	10-30g	
CDC72MHGEUA	2.18m	218cm	1	145g	10-30g	
CDC75HEUA	2.26m	226cm	1	130g	14-42g	
CDC70MH2EUA	2.13m	110cm	2	-	10-30g	<b>NEW</b>
CDC72MLBF52EUA	2.18m	113cm	2	-	5-15g	<b>NEW</b>
CDC72M2EUA	2.18m	113cm	2	-	7-21g	<b>NEW</b>
CDC72H2EUA	2.18m	113cm	2	-	14-42g	<b>NEW</b>
CDC75XH2EUA	2.26m	117cm	2	-	18-56g	<b>NEW</b>



## SEARCH YOUR PERFECT MATCH...

This chart shows which kind of lure is most suited to each model of the Curado Spinning and Casting range. The stars indicate the rating based on 'Excellent', 'Great' and 'Good'.

\*\*\* = Excellent  
 \*\* = Great  
 \* = Good

MODEL	SUITABLE LURE WEIGHT (G)	TEXAS RIG	LIGHT TEXAS RIG	HEAVY DROPSHOT	DROPSHOT	RUBBER JIG	SMALL RUBBER JIG	JIG HEAD RIG	JIG HEAD WACKY	NEKO RIG	WEIGHTLESS RIG	DROP SHOT RIG	CAROLINA RIG	CRANKBAIT	LIPLESS CRANKBAIT	MINNOW / JERKBAIT	SHAD BAIT	TOP WATER	SPINNER BAIT	SWIM & BIG BAITS	FROG	
<b>CURADO SPINNING</b>		<b>SUITABLE PLASTIC WORM &amp; JIG</b>											<b>SUITABLE WOBBLER</b>									
CDS70LEUA	2-10g		*		**		***	***	***	***	***	***	**	*	*	***	***	*				
CDS70MLEUA	3.5-12g		**	*	**	*	**	***	***	***	***	***	**	*	*	***	***	*	*			
CDS70MEUA	5-15g	*	**	***	**	*	***	***	***	***	***	***	***		**	***	**	*	*		*	
CDS70L2EUA	2-10g		*		**		***	***	***	***	***	***	**	*	*	***	***	*				
CDS70ML2EUA	4-12g		**	*	**	*	**	***	***	***	***	***	**	*	*	***	***	*	*			
CDS70M2EUA	5-15g	*	**	***	**	*	***	***	***	***	***	***	***		**	***	**	*	*		*	
CDS72MH2EUA	7-21g	***	*	*			***						***	**	**	*		**	***	*	*	
<b>CURADO CASTING</b>		<b>SUITABLE PLASTIC WORM &amp; JIG</b>											<b>SUITABLE WOBBLER</b>									
CDC610MEUA	7-21g	**	**	**	*	**				*	*			**	***	***	**	***	***			
CDC72MLBF5EUA	5-15g		**	*	***		***	**	***	***	***	*		**	**	**	**	**	*	*		
CDC72MHEUA	10-28g	***	*	*		***							***	**	**	*		**	***	*	*	
CDC72MHGEUA	10-28g	***	*	*		***							***	*	**			*	***	*	***	
CDC75HEUA	14-42g	**	*																			
CDC70MH2EUA	10-30g	***	*	*		***							***	**	**	*		**	***	*	*	
CDC72MLBF52EUA	5-15g		**	*	***		***	**	***	***	***	*		**	**	**	**	*	*			
CDC72M2EUA	7-21g	***	*	*		***		***					***	***	***	*		**	***	*	*	
CDC72H2EUA	14-42g	***	*	*		***		***					***	*	**		**	*	***	***	***	
CDC75XH2EUA	18-56g					***		***						*	**		***	*	***	***	***	



## BASS ONE XT

### SPINNING / CASTING

- Bass One XT is designed for multi-purpose predator fishing
- Look and feel of a high-end rod, but with a very affordable price in both spinning and baitcasting models
- High Modulus Full Carbon blank for responsive performance
- Fuji Concept 'O' guides
- Unique SHIMANO JDM designed reel seat
- Versatile range suitable for fishing ultra light lures (1-5g) up to medium sized lures (35g)



#### SPINNING

BOXT263UL2	1.90m	98cm	2	97g	1-5g
BOXT266L2	1.98m	102cm	2	100g	2-7g
BOXT266ML2	1.98m	102cm	2	100g	3-10g

#### CASTING

BOXT162ML2	1.88m	97cm	2	107g	5-14g
BOXT166M2	1.98m	102cm	2	117g	7-21g
BOXT1610MH2	2.08m	107cm	2	125g	10-28g
BOXT1610H2	2.08m	107cm	2	122g	12-35g

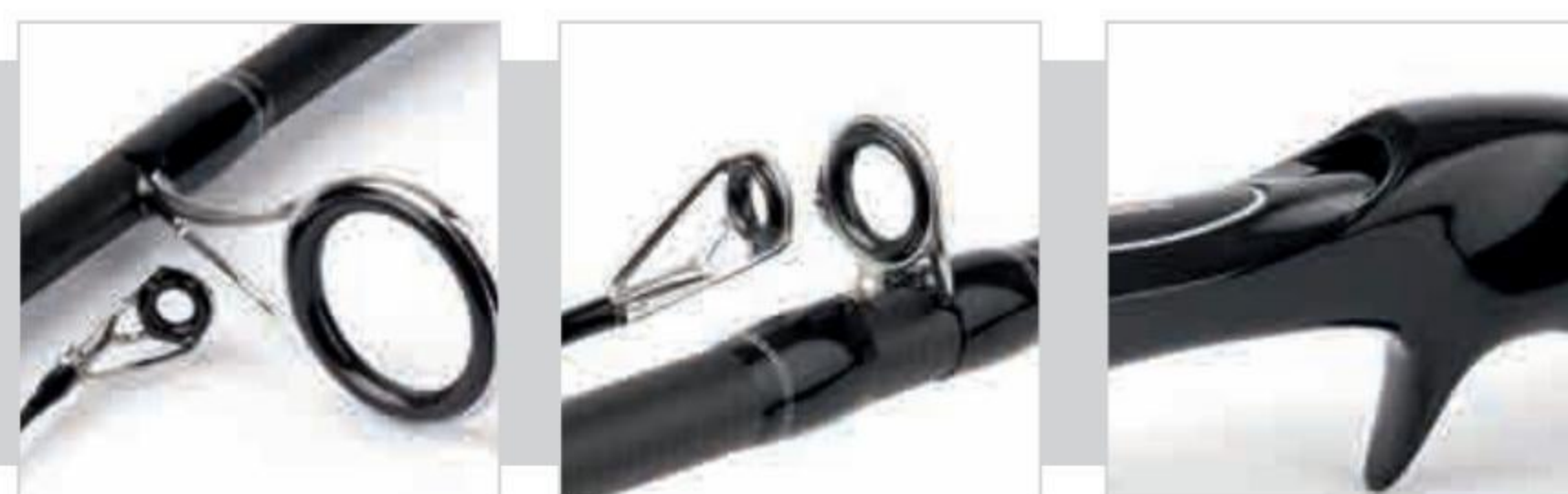

## SEARCH YOUR PERFECT MATCH...

This chart shows which kind of lure is most suited to each model of the Bass One XT Spinning and Casting range. The stars indicate the rating based on 'Excellent', 'Great' and 'Good'.

★★★ = Excellent  
★★ = Great  
★ = Good

MODEL	SUITABLE LURE WEIGHT (G)	TEXAS RIG	LIGHT TEXAS RIG	HEAVY DROPSHOT	DROPSHOT	RUBBER JIG	SMALL RUBBER JIG	JIG HEAD RIG	JIG HEAD WACKY	NEKO RIG	WEIGHTLESS RIG	SPLIT SHOT RIG	CAROLINA RIG	CRANKBAIT	LIPLESS CRANKBAIT	MINNOW / JERKBAIT	SHAD BAIT	TOP WATER	SPINNER BAIT	SWIM & BIG BAITS	FROG	
<b>BASS ONE XT SPINNING</b>		<b>SUITABLE PLASTIC WORM &amp; JIG</b>										<b>SUITABLE WOBBLER</b>										
BOXT263UL2	1-5g				★★★		★★★	★★★	★★★	★★★	★★★					★★						
BOXT266L2	2-7g			★	★		★★★	★★★	★★★	★★★	★★★	★★				★★★	★★					
BOXT266ML2	3-10g		★★	★★	★★		★★	★★★	★★	★★★	★★★	★★★	★★	★★		★★★	★★★					
<b>BASS ONE XT CASTING</b>		<b>SUITABLE PLASTIC WORM &amp; JIG</b>										<b>SUITABLE WOBBLER</b>										
BOXT162ML2	5-14g	★	★★	★	★	★	★		★	★	★			★★★		★★★	★★★	★★★	★★★			
BOXT166M2	7-21g	★★	★★	★★	★	★★				★	★			★★	★★★	★★★	★★	★★★	★★★			
BOXT1610MH2	10-28g	★★★	★	★★		★★★									★★	★		★★	★★★	★	★★	
BOXT1610H2	12-35g	★★★		★		★★★							★★★	★	★			★	★★★	★★★	★★★	

# YASEI RODS





# YASEI

## EVERY ROD TELLS A STORY

**We all know that feeling...The excitement of the adventure, the anticipation when targeting that specific fish, and the adrenaline that runs through your body when a big predator fish finally strikes onto your lure. BANG! This is why we love fishing!**

To support you in your fishing adventure and enhance that feeling, SHIMANO developed a range of rods named YASEI. This unique range of rods consists of three series and is built for European predator anglers of all abilities to cater for every specific technique, targeting the biggest predator species out there. This range was developed to be as diverse as the disciplines it allows you to accomplish, from the finesse technique of dropshotting baits centimeters from the bottom through to grinding crankbaits over boulders.

So, it doesn't matter if you just started fishing or if you're a long time professional, the YASEI range of rods offer you the best tools for all your needs!



# YASEI LTD RODS



270XH

TARGET FISH: PIKE & ZANDER

## YASEI LTD BIG SOFTBAIT

- Designed with the power and action required to cast and retrieve the largest softbaits when fishing for large predators
- Spiral X Core and Nanopitch blank construction ensures you are never under-gunned even with large lures on the biggest waters
- Fuji SiC K-type guides minimise effect on the rods action and improve casting and retrieve performance
- Cork handle with custom Ci4+ Perfection reel seat for rock solid performance



YASLTDBSS270XH					
	2.70m	139cm	2	159g	60-120g



225XH Crank & Spinnerbait

TARGET FISH: PIKE

## YASEI LTD PIKE

- Available in Crank & Spinnerbait and Swim & Softbait actions, these models make a perfect combination for the experienced pike angler who likes a cast and retrieve approach
- Spiral X Core and Nanopitch blank construction delivers strength and enhances lure action
- Fuji SiC guides minimise effect on the rods action and improve casting and retrieve performance
- Cork handle with custom Ci4+ Perfection / Fuji PTSS reel seats



CASTING MODELS					
CRANK & SPINNERBAIT					
YASLTDP225XH	2.25m	117cm	2	160g	50-110g
SWIM & SOFTBAIT					
YASLTDP255XXH	2.55m	132cm	2	253g	60-180g



215MLP

TARGET FISH: PERCH, ASPIUS, ZANDER & PIKE

## YASEI LTD POWER FINESSE

- Designed specifically to handle reaction lures which cover vast amounts of water, perfect for a wide variety of small to medium hardbaits
- Spiral X Core and Nanopitch regular-fast action blank construction for hidden strength to control powerful fish
- The special curve progression of the rod always ensures the optimal line tension so you don't lose your bite
- Fuji SiC K-type guides for faultless performance
- Carbon Monocoque combined with Cork handle with custom Ci4+ Perfection reel seat



YASLTDPF215MLP					
	2.15m	135cm	2	107g	7-21g



TARGET FISH: PERCH

215ML Crankbait

# YASEI LTD PERCH

- Designed specifically for perch, the Crankbait version is great for covering large amounts of water, whilst the Finesse Softbait is perfect for a more targeted 'area' style
- Spiral X Core and Nanopitch blank construction deliver great feel and responsive action to detect the smallest bites
- Fuji SiC KR-type guides minimise effect on the rods action and improve casting and retrieve performance
- Carbon Monocoque combined with Cork handle with custom Ci4+ Perfection reel seat
- Taftec Alpha technology (YASLTDPE225ML & YASLTDPE260ML models only) for amazing sensitivity



CASTING MODELS					
CRANKBAIT					
YASLTDPE215ML	2.15m	111cm	2	105g	4-16g
FINESSE SOFTBAIT					
YASLTDPE225ML	2.25m	116cm	2	95g	5-18g
YASLTDPE260ML	2.60m	134cm	2	116g	3-21g



TARGET FISH: ZANDER

198M Vertical Jigging

# YASEI LTD ZANDER

- A range of zander rods to cover all styles. The Vertical Jigging model is lightweight but with the correct amount of action to put extra life into lures, The River Jigging has a longer length making it perfect for bank fishing and Finesse Jigging balances additional length with a supreme action
- Spiral X Core and Nanopitch blank construction for strength and responsive performance
- Fuji SiC K-type guides for faultless performance
- Carbon Monocoque combined with Cork handle with custom Ci4+ Perfection reel seats



CASTING MODELS					
VERTICAL JIGGING					
YASLTDVZA198M	1.98m	168cm	2	98g	12-28g
RIVER JIGGING					
YASLTDZA270H	2.70m	139cm	2	149g	20-70g
FINESSE JIGGING					
YASLTDZA270M	2.70m	139cm	2	138g	10-35g

## SEARCH YOUR PERFECT MATCH...

This chart shows which kind of lure is most suited to each model of the Yasei LTD range. The stars indicate the rating based on 'Excellent', 'Great' and 'Good'.

★★★ = Excellent  
★★ = Great  
★ = Good

MODEL	SUITABLE LURE WEIGHT (G)	TEXAS RIG	LIGHT TEXAS RIG	CAROLINA RIG	LIGHT CAROLINA RIG	NED RIG	TUBES	JIKA RIG	WACKY RIG	NEKO RIG	FREE RIG	SOFTBAIT ULTRA	SOFTBAIT LIGHT	SOFTBAIT MED/HEAVY	DROPSHOT	FROG	CRANKBAIT MAX 15G	CRANKBAIT 20G+	LIPLESS CRANKBAIT	METAL VIBRATION	TWITCHBAIT	JERKBAIT/SLIDEBAIT	GLIDEBAIT	JOINTED MAX 15G	JOINTED 20G+	POPPERS	STICKBAIT	SPINNERBAIT LIGHT	SPINNERBAIT 40G+	SWIN & BIG BAITS 80G+
YASLTDVZA198M	12-28g												★	★★★					★											
YASLTDZA270H	20-70g													★★★					★											
YASLTDZA270M	10-35g					★							★★	★★★	★															
YASLTDPE225ML	5-18g	★	★★★	★	★★★	★★★	★★★	★★	★★	★★	★★★	★	★★	★	★★														★★	
YASLTDPE260ML	3-21g	★	★★★	★	★★★	★★★	★★★	★★	★★	★★	★★★	★★	★★	★★	★★														★★	
YASLTDBSS270XH	60-120g													★★									★★		★				★★	★★★
YASLTDPF215MLP	7-21g												★			★★★	★★★	★★	★★★	★★★	★★★	★		★★		★★★	★★★	★★		
YASLTD225XH	50-110g																	★★★	★★			★★		★★				★★★	★★	
YASLTD225XXH	60-180g																						★★★					★★	★★★	
YASLTDPE215ML	4-16g																★★★		★★★	★★	★★			★★★			★★			

# YASEI RODS



## YASEI PIKE CASTING

- Highly responsive and incredibly light High Modulus Full Carbon + HPC + Nanosheet blank designed for use with baitcasting reels and larger lures of all types
- Fuji Stainless Steel Alconite K-Type guides
- Fuji PSS Palming reel seat with split EVA handle
- For use with large and extra large Crankbaits, Softbaits, Spoons, Jerkbaits, Hybrid Baits and Spinnerbaits



NANOSHEET

TARGET FISH: PIKE



### CASTING MODELS

YASPIC21H	2.10m	169cm	2(SH)*	120g	20-60g
YASPIC23XXH	2.30m	189cm	2(SH)*	190g	56-170g
YASPIC25XH	2.50m	128cm	2	146g	40-100g
YASPIC250XXH	2.50m	128cm	2	223g	56-170g
YASPIC26	2.60m	133cm	2	269g	120-270g

### CASTING MODELS CORK HANDLE

YASPIC25XHC	2.50m	128cm	2	173g	40-100g
YASPIC250XXHC	2.50m	128cm	2	262g	56-170g



## YASEI PIKE SPINNING

- Highly responsive and incredibly light High Modulus Full Carbon + HPC + Nanosheet blank with excellent casting performance and hidden power for fishing close to structure
- Fuji Stainless Steel Alconite K-Type guides
- SHIMANO designed custom reel seat with split EVA handle
- For use with small and medium Crankbaits, Softbaits, Spoons, Jerkbaits, Hybrid Baits and Spinnerbaits



NANOSHEET

TARGET FISH: PIKE



YASPI21H	2.10m	169cm	2(SH)*	119g	20-60g
YASPI25XH	2.50m	128cm	2	138g	40-100g
CORK HANDLE					
YASPI25XHC	2.50m	129cm	2	156g	40-100g



## YASEI DROPSHOT LIGHT JIG

- Highly responsive and incredibly light High Modulus Full Carbon + HPC + Nanosheet blank with soft tip designed for Dropshot and light Jigging
- Fuji Stainless Steel Alconite K-Type guides
- SHIMANO designed custom reel seat with tapered front part for sensitivity and split EVA handle
- For use with Dropshot and light Jigging



NANOSHEET

TARGET FISH: PERCH & ZANDER



YASDS210ML	2.10m	178cm	2(SH)*	96g	5-18g
YASDS240M	2.40m	124cm	2	124g	7-21g



## YASEI JERK BAIT

- Highly responsive and incredibly light High Modulus Full Carbon + HPC + Nanosheet blank designed to put maximum life into Jerkbaits
- Fuji Stainless Steel Alconite K-Type guides
- SHIMANO designed custom reel seat with split EVA handle
- For use with medium and large Jerkbaits, trolling and Crankbaits



NANOSHEET

TARGET FISH: PIKE



CASTING MODEL					
YASJBC198H	1.98m	160cm	2(SH)*	162g	45-100g
CASTING MODEL CORK HANDLE					
YASJBC198HC	1.98m	160cm	2(SH)*	162g	45-100g



TARGET FISH: PERCH & ZANDER

# YASEI FINESSE JIG & DROPSHOT

- Highly responsive High Modulus Full Carbon + HPC + Nanosheet blank with exceptional sensitivity designed for lightweight jig and dropshot fishing
- Fuji Stainless Steel Alconite K-Type guides
- SHIMANO designed custom reel seat with split EVA handle
- Extremely lightweight blank balances perfectly with a SHIMANO 1000 reel for street fishing



YASDS205L	2.05m	105cm	2	88g	3-12g
-----------	-------	-------	---	-----	-------



TARGET FISH: PERCH

# YASEI PERCH TWITCH & JERK

- Highly responsive and incredibly light High Modulus Full Carbon + HPC + Nanosheet blanks, designed for use with Baitcasting reels
- Fuji Stainless Steel Alconite K-Type guides
- SHIMANO designed custom reel seat and split EVA handle
- Perfect for perch fishing with Twitch and Jerkbait type lures



CASTING MODELS					
YASPTJ203L	2.03m	106cm	2	92g	5-12g
YASPTJ215LP	2.15m	110cm	2	106g	9-18g



TARGET FISH: PERCH

# YASEI PERCH

- Highly responsive and incredibly light High Modulus Full Carbon + HPC + Nanosheet blanks, perfect for street fishing
- Fuji Stainless Steel Alconite K-Type guides
- SHIMANO designed custom reel seat and split EVA handle
- For use with small Jigs, Spinners, Crankbaits and Dropshot



YASP195L	1.95m	168cm	2(SH)*	87g	3-12g
YASP210ML	2.10m	180cm	2(SH)*	94g	7-18g
CORK HANDLE					
YASP210MLC	2.10m	109cm	2	119g	7-18g
YASP225MC	2.25m	116cm	2(SH)*	130g	10-25g

# YASEI RODS



**TARGET FISH: ASPIUS**

## YASEI ASPIUS

- Highly responsive high modulus full carbon + HPC + Nanosheet blank with exceptional strength designed for Aspius fishing
- Fuji Stainless Steel Alconite K-Type guides
- SHIMANO designed custom reel seat with split EVA handle
- Excellent long range casting performance to reach feeding asp at distance using crankbaits and top water lures

YASASP27MH					
	2.70m	139cm	2	148g	10-35g



**TARGET FISH: PERCH, PIKE, ZANDER & ASPIUS**

## YASEI CRANKBAIT

- Highly responsive and incredibly light High Modulus Full Carbon + HPC + Nanosheet blank designed for long range casting of small and medium Crankbaits
- Fuji Stainless Steel Alconite K-Type guides
- SHIMANO designed custom reel seat with split EVA handle
- For use with small and medium Crankbaits

CASTING MODEL YASCR22M					
	2.20m	112cm	2	110g	8-24g





TARGET FISH: ZANDER

## YASEI ZANDER SHAD

- Highly responsive and incredibly light High Modulus Full Carbon + HPC + Nanosheet blank designed for jighead fishing from the bank or casting from a boat
- Fuji Stainless Steel Alconite K-Type guides
- SHIMANO designed custom reel seat with split EVA handle
- For use with softbaits ranging in size from 10g (Medium model) up to 56g (Heavy model)



YASZS24M	2.40m	124cm	2	120g	12-28g
YASZS27M	2.70m	138.5cm	2	137g	12-28g
YASZS27H	2.70m	138.5cm	2	161g	24-56g



TARGET FISH: ZANDER

## YASEI ZANDER VERTICAL JIG

- Highly responsive and incredibly light High Modulus Full Carbon + HPC + Nanosheet blank with a sensitive tip for maximum feel
- Fuji Stainless Steel micro guides for sensitivity and lightness
- SHIMANO designed custom reel seat with split EVA handle
- Separate handle for improved playing action
- For use with softbaits and Fireball type techniques



YASVJS19	1.90m	162cm	2(SH)*	103g	14-28g
CASTING MODEL					
YASVJC19	1.90m	163cm	2(SH)*	101g	14-28g



TARGET FISH: ZANDER

## YASEI ZANDER DEADBAIT

- Highly responsive and incredibly light High Modulus Full Carbon + HPC + Nanosheet blank with a 'classic' parabolic through action
- Fuji Stainless Steel Alconite K-Type guides
- SHIMANO designed custom reel seat with split EVA handle
- For use with small and medium Deadbaits



YASZDB27	2.70m	139cm	2	162g	5-15g



# FAST ACTION FOR JIGGING



V195 Zander Vertical

**TARGET FISH: ZANDER**

## YASEI BB ZANDER

- ZANDER VERTICAL - Fast action for effective vertical jigging when fishing with softbaits for zander making it perfect for boat or close in deep water bank fishing
- ZANDER LURE - A great all round zander rod which can be used for many methods. The additional 2.70m length offers good casting performance when using crankbaits whilst the extra fast action increases lure action when using softbaits
- Responsive, lightweight strong Full Carbon + HPC blanks deliver excellent balance to improve the fishing experience and reduce fatigue
- Split cork/EVA handle with SHIMANO VSS reel seat
- Anti-tangle Seaguide XOG guides for improved casting



ZANDER VERTICAL  
YASBBZV195  
ZANDER LURE  
YASBBZL270H

ZANDER VERTICAL YASBBZV195	1.95m	100.5cm	2	110g	10-30g
ZANDER LURE YASBBZL270H	2.70m	138.5cm	2	165g	15-50g







## SEARCH YOUR PERFECT MATCH...

This chart shows which kind of lure is most suited to each model of the Yasei BB range. The stars indicate the rating based on 'Excellent', 'Great' and 'Good'.

★★★ = Excellent  
★★ = Great  
★ = Good

MODEL	SUITABLE LURE WEIGHT (G)	TEXAS RIG	LIGHT TEXAS RIG	CAROLINA RIG	LIGHT CAROLINA RIG	NED RIG	TUBES	JIKA RIG	WACKY RIG	NEKO RIG	FREE RIG	SOFTBAIT ULTRA	SOFTBAIT LIGHT	SOFTBAIT MED/HEAVY	DROPSHOT	FROG	CRANKBAIT MAX 15G	CRANKBAIT 20G+	LIPLESS CRANKBAIT	METAL VIBRATION	TWITCHBAIT	JERKBAIT/ SLIDEBAIT	GLIDEBAIT	JOINTED MAX 15G	JOINTED 20G+	POPPERS	STICKBAIT	SPINNERBAIT LIGHT	SPINNERBAIT 40G+	SWIM & BIG BAITS 80G+	
YASBBZV195	10-30g												★	★★★					★												
YASBBZL270H	15-50g												★	★★★					★												
YASBBPER190L	3-12g	★★★			★★★	★★★	★★★	★★	★★★	★★	★★★	★★	★★★		★★		★★			★★				★★		★★	★★				
YASBBST190ULP	2-10g	★★★			★★★	★★★	★★★	★★	★★★	★★	★★★	★★	★★		★★★		★			★★				★		★★	★★				
YASBBST210L	3-12g		★★		★★	★★★	★★★	★★	★★★	★★	★★★	★★	★★★		★★★	★★	★★			★★	★★			★★		★★	★★				
YASBBST225ML	5-15g	★	★★★	★	★★★	★★★	★★★	★★	★★	★★	★★★	★	★★★	★	★★★	★★★	★★			★★★	★★★			★★		★★★	★★★	★★			
YASBBCCR230	5-20g																★★★		★★★		★★			★★★	★				★		
YASBBP230H	15-50g													★★★		★		★★					★★		★★★			★★★	★		
YASBBP250XH	30-90g													★★								★★	★★★		★★			★	★★★	★★	
YASBBCP230XH	30-90g													★★								★	★★		★★			★	★★★	★★	
YASBBCJB195HP	30-75g																					★★★	★★★								
YASBBCP250XXH	50-120g													★									★★		★★				★★	★★★	

# YASEI BB RODS



TARGET FISH: PIKE

250XXH

## YASEI BB CAST & TROLL

- Fast action for trolling or casting with large hardbaits and softbaits
- Responsive, lightweight, strong Full Carbon + HPC blanks maintain their integrity when trolling large lures
- Split cork/EVA handle, EVA front grip with SHIMANO custom BC reel seat
- Anti-tangle Seaguide XOG guides for improved casting



CASTING MODEL  
YASBBP250XXH

2.50m	128.5cm	2	165g	50-120g



TARGET FISH: PIKE

250XXH

## YASEI BB PIKE SPIN

- Versatile fast action for use with hardbaits, softbaits and spinners
- Responsive, lightweight strong Full Carbon + HPC blanks, the longer 2.50m offers increased casting and more playing power
- Split cork/EVA handle with SHIMANO VSS reel seat
- Anti-tangle Seaguide XOG guides for improved casting



YASBBP230H  
YASBBP250XH

2.30m	118.5cm	2	141g	15-50g
2.50m	128.5cm	2	153g	30-90g



TARGET FISH: PIKE

230XXH

## YASEI BB PIKE CASTING

- Designed for use with baitcasting reels
- Responsive, lightweight strong Full Carbon + HPC blanks with a fast action for quick strikes
- Split cork/EVA handle, EVA front grip with SHIMANO BC reel seat
- Anti-tangle Seaguide XOG guides for improved casting



CASTING MODEL  
YASBBP230XH

2.30m	118.5cm	2	153g	30-90g



TARGET FISH: PIKE

195HP

## YASEI BB PIKE JERKBAIT

- Extra fast action for use with medium and large jerkbaits with a baitcasting reel
- Responsive, lightweight, strong Full Carbon + HPC blanks
- Split cork/EVA handle, EVA front grip with SHIMANO BC reel seat
- Anti-tangle Seaguide XOG guides for improved casting



CASTING MODEL  
YASBBCB195HP

1.95m	100.5cm	2	140g	30-75g



TARGET FISH: ASPIUS

270MH

## YASEI BB ASPIUS

- Fast action for long range casting with hardbaits and spoons when fishing at range on large European rivers
- Responsive, lightweight, strong Full Carbon + HPC blanks
- Split cork/EVA handle with SHIMANO VSS reel seat
- Anti-tangle Seaguide XOG guides for improved casting



YASBBASP270MH



2.70m



138.5cm



2



143g



10-35g



TARGET FISH: PERCH, PIKE, ZANDER & ASPIUS

230

## YASEI BB CRANKBAIT

- Versatile moderate fast action for using with a baitcasting reel when fishing small and medium crankbaits
- Responsive, lightweight, strong Full Carbon + HPC blanks can be used for multiple species
- Split cork/EVA handle, EVA front grip with SHIMANO BC reel seat
- Anti-tangle Seaguide XOG guides for improved casting



CASTING MODEL  
YASBBCCR230



2.30m



118.5cm



2



118g



5-20g



TARGET FISH: PERCH

190L

## YASEI BB PERCH

- Sensitive fast action for lightweight lure fishing for perch
- Responsive, lightweight strong Full Carbon + HPC blank has exceptional balance and responsiveness making it perfect for all softbait and small crankbait fishing
- Split cork/EVA handle with SHIMANO VSS reel seat
- Anti-tangle Seaguide XOG guides for improved casting



YASBBPER190L



1.90m



98cm



2



91g



3-12g



TARGET FISH: PERCH & ZANDER

210L

## YASEI BB STREET

- Available in three lengths, all with a fast action for lightweight 'Street' lure fishing
- Responsive, lightweight strong Full Carbon + HPC blanks
- Split cork/EVA handle with SHIMANO VSS reel seat
- Anti-tangle Seaguide XOG guides for improved casting



YASBBST190ULP

YASBBST210L

YASBBST225ML



1.90m



98cm



2



90g



2-10g



2.10m



108.5cm



2



103g



3-12g



2.25m



116cm



2

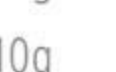

110g



5-15g

# VERSATILE SPINNING

**MULTI PIECE SPINNING  
TELESCOPIC SPINNING | SUPER SENSITIVE  
ICE FISHING**



# VERSATILE ACTION

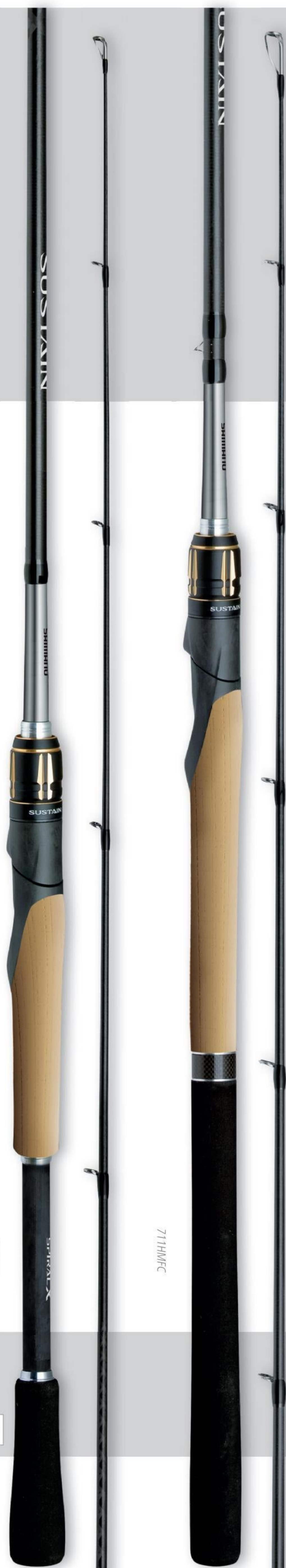

NEW

## SUSTAIN

- Lightweight High Modulus Full Carbon Spiral X blanks
- Ultra lightweight SHIMANO Ci4+ custom reel seat for superb balance
- Fuji K-type Alconite guides for mono and braid lines
- Split (extra-fast action) or full (moderate-fast action) Cork/EVA handles
- Available in wide range of extra-fast and moderate-fast actions



### FAST ACTION

SSUSBX61ULFE	1.85m	157cm	2 (SH)*	-	2-8g
SSUSBX63LFE	1.90m	163cm	2 (SH)*	-	3-14g
SSUSBX68MLFE	2.03m	172cm	2 (SH)*	-	5-21g
SSUSBX610MFE	2.08m	177cm	2 (SH)*	-	7-28g
SSUSBX70MHFE	2.13m	181cm	2 (SH)*	-	14-42g
SSUSBX74MLFE	2.23m	116cm	2	-	5-21g
SSUSBX78MFE	2.34m	121cm	2	-	7-28g
SSUSBX79MHFE	2.36m	122cm	2	-	14-42g
SSUSBX82HFE	2.49m	129cm	2	-	21-56g
SSUSBX86XHPFE	2.59m	134cm	2	-	50-120g
SSUSBX810MFE	2.69m	129cm	2	-	7-28g
SSUSBX810MHFE	2.69m	129cm	2	-	14-42g
SSUSBX90HFE	2.74m	142cm	2	-	21-56g
SSUSBX90XHFE	2.74m	142cm	2	-	42-84g
SSUSBX910HFE	2.99m	155cm	2	-	21-56g
CSUSBX63MFE	1.90m	162cm	2 (SH)*	-	7-28g
CSUSBX610XHFE	2.08m	170cm	2 (SH)*	-	42-84g

### MODERATE - FAST ACTION

SSUSBX55ULMFC	1.65m	86cm	2	-	2-8g
SSUSBX611LMFC	2.11m	109cm	2	-	3-14g
SSUSBX611MMFC	2.11m	110cm	2	-	7-28g
SSUSBX711LMFC	2.42m	125cm	2	-	3-14g
SSUSBX711MMFC	2.42m	125cm	2	-	7-28g
SSUSBX711MHMFC	2.42m	125cm	2	-	14-42g
SSUSBX711HMFC	2.42m	125cm	2	-	21-56g
SSUSBX810MLMFC	2.69m	139cm	2	-	5-21g
SSUSBX810MMFC	2.69m	139cm	2	-	7-28g
SSUSBX810MHMFC	2.69m	139cm	2	-	14-42g
SSUSBX810HMFC	2.69m	139cm	2	-	21-56g
SSUSBX810XHMFC	2.69m	139cm	2	-	42-84g
SSUSBX910MMFC	2.99m	155cm	2	-	7-28g
SSUSBX910HMFC	2.99m	155cm	2	-	21-56g



# VERSATILE SPINNING RODS



## NORDEN SP

80ML4

- Slim, lightweight, responsive High Modulus Full Carbon + HPC + Nanosheet blank designed for a wide range of lure fishing techniques
- The Norden rod series is developed for anglers who are looking for mobility, but at the same time don't want to sacrifice performance
- Available in 4 piece and 3 piece options, in lengths ranging from 7'0" (2.13m) to 11'0" (3.35m)
- Anti-tangle Seaguide XOG guides for improved casting
- Cork handle with custom designed SHIMANO reel seat
- All rods have an excellent 'special progressive' action, which differs when working lures and when fighting fish, to ensure optimal angler control in each situation

NORSP70UL4	2.13m	57cm	4	107g	0.5-7g
NORSP70L4	2.13m	57cm	4	102g	2-10g
NORSP76LP4	2.29m	61cm	4	118g	3-15g
NORSP80ML4	2.44m	65cm	4	131g	5-21g
NORSP80M4	2.44m	65cm	4	136g	7-28g
NORSP86ML4	2.59m	69cm	4	137g	5-21g
NORSP90M4	2.74m	73cm	4	149g	7-28g
NORSP90MP4	2.74m	73cm	4	150g	10-35g
NORSP10MH3	3.05m	106cm	3	196g	10-50g
NORSP11H3	3.35m	116cm	3	220g	20-60g



## TECHNIUM AX

68ML

- High Modulus Full Carbon blank with fast, strong, powerful and highly responsive action
- Increased tip sensitivity to suit modern lure trends and re-designed balance for improved casting distance
- Fuji Fazlite anti-tangle K/KR guides reduce tangles and increase blank performance
- Fuji TVS reel seat for L/ML/M rods (light and sensitive)
- Fuji VSS reel seat for MH/H/XH/XXH rods (grip and power)

TECAXF65M	1.95m	167cm	2 (SH)*	99g	7-35g
TECAXF66L	1.98m	170cm	2 (SH)*	100g	3-14g
TECAXF68ML	2.03m	107cm	2	100g	7-21g
TECAXF610M	2.08m	109cm	2	116g	7-35g
TECAXF70MH	2.13m	112cm	2	109g	14-42g
TECAXF78L	2.33m	122cm	2	113g	3-14g
TECAXF78ML	2.33m	122cm	2	123g	7-21g
TECAXF710M	2.38m	124cm	2	128g	7-35g
TECAXF80MH	2.44m	127cm	2	130g	14-42g
TECAXF82H	2.49m	130cm	2	147g	21-56g
TECAXF84XH	2.54m	132cm	2	150g	28-84g
TECAXF86XXHSS	2.59m	135cm	2	169g	45-135g
TECAXF810ML	2.69m	140cm	2	168g	7-21g
TECAXF810MH	2.69m	140cm	2	169g	14-42g
TECAXF90H	2.74m	142cm	2	171g	21-56g
TECAXF90XH	2.74m	142cm	2	173g	28-84g
TECAXF910H	3.00m	155cm	2	182g	21-56g



24M

## BeastMaster FX

- Redesigned moderate-fast action Full Carbon + Nanosheet blank in the classic Beastmaster black gloss and gold colour scheme
- Fuji Fazlite anti-tangle K Type guides for improved blank action
- Special custom reel seat and ergonomic cork handle complements the understated black blank perfectly
- Available in a wide range of models to suit almost all spinning and lure methods from ultra lightweight jiggging to the largest crankbaits

NANOSHEET

SBMFXMF165UL	1.65m	85cm	2	81g	1-11g
SBMFXMF18L	1.80m	93cm	2	91g	3-14g
SBMFXMF21ML	2.10m	108cm	2	100g	5-21g
SBMFXMF21M	2.10m	108cm	2	106g	7-28g
SBMFXMF21H	2.10m	108cm	2	126g	21-56g
SBMFXMF24L	2.40m	108cm	2	121g	3-14g
SBMFXMF24ML	2.40m	123cm	2	125g	5-21g
SBMFXMF24M	2.40m	123cm	2	129g	7-28g
SBMFXMF24MH	2.40m	123cm	2	130g	14-42g
SBMFXMF24H	2.40m	123cm	2	140g	21-56g
SBMFXMF24XHP	2.40m	123cm	2	149g	50-120g
SBMFXMF27ML	2.70m	138cm	2	127g	5-21g
SBMFXMF27M	2.70m	138cm	2	135g	7-28g
SBMFXMF27MH	2.70m	138cm	2	152g	14-42g
SBMFXMF27H	2.70m	138cm	2	165g	21-56g
SBMFXMF27XH	2.70m	138cm	2	176g	42-84g
SBMFXMF30M	3.00m	154cm	2	152g	7-28g
SBMFXMF30MH	3.00m	154cm	2	161g	14-42g
SBMFXMF30H	3.00m	154cm	2	176g	21-56g
SBMFXMF33HP	3.30m	168cm	2	204g	28-70g
SBMFXMF36HP	3.60m	183cm	2	217g	28-70g



270H Deadbait



610MFE

## SEDONA

- The series consists of a blend of fast-action and moderate-action rods that are perfectly fitted for the modern lure angler
- Reinforced X carbon tape construction (Diaflash) on butt section only, resulting in increased compression strength and impact resistance
- Versatile range of rods for bass, perch, zander and pike
- Special models specifically created for dead baiting and chub fishing
- Full Carbon + Diaflash construction blanks
- Seaguide XOG guides



<b>FAST ACTION EVA HANDLE</b>					
SED710MHFE	2.39m	123cm	2	134g	14-42g
SED80XHFE	2.44m	125cm	2	164g	28-84g
SED82HFE	2.49m	128cm	2	149g	21-56g
SED810MHFE	2.69m	138cm	2	151g	14-42g
SED90HFE	2.74m	140cm	2	167g	21-56g
SED90XHFE	2.74m	140cm	2	168g	28-84g
<b>MODERATE ACTION CORK HANDLE</b>					
SED55ULMFC	1.65m	85cm	2	88g	1-7g
SED611LMFC	2.11m	109cm	2	102g	3-14g
SED611MMFC	2.11m	109cm	2	112g	7-35g
SED711MMFC	2.42m	124cm	2	127g	7-35g
SED711MHMFC	2.42m	124cm	2	132g	14-42g
SED810MMFC	2.69m	138cm	2	140g	7-35g
SED810HMFC	2.69m	138cm	2	155g	21-56g
<b>DEADBAIT</b>					
SEDDBS270H	2.70m	138cm	2	177g	20-60g
SEDDBS270XH	2.70m	138cm	2	180g	30-100g
<b>CHUB SPECIALIST</b>					
SEDCHUB810L	2.69m	138cm	2	131g	5-15g
SEDCHUB910L	2.99m	153cm	2	143g	5-15g

<b>FAST ACTION EVA HANDLE</b>					
SED61ULFE	1.85m	96cm	2	83g	1-7g
SED63LFE	1.90m	98cm	2	92g	3-14g
SED68MLFE	2.03m	105cm	2	100g	7-21g
SED610MFE	2.08m	107cm	2	112g	7-35g
SED70MHFE	2.13m	110cm	2	126g	14-42g
SED74MLFE	2.23m	115cm	2	108g	7-21g
SED78MFE	2.34m	120cm	2	128g	7-35g

# VERSATILE SPINNING RODS



NEW

## NASCI



- Strong and lightweight full carbon blanks
- Diaflash construction on butt sections to minimize blanks twist under pressure, resulting in efficient power transfer from angler to fish
- Biofibre construction on tip sections to increase pulling power and control over fish

- Custom designed fast and moderate fast rod actions depending on model
- Seaguide Stainless Steel XOG guides with Zirconia rings
- SHIMANO custom reel seats with ergonomic design
- Graphics and colors matching Nasci reels

<b>FAST ACTION</b>					
NAS61ULFE	1.85m	96cm	2	84g	1-7g
NAS63LFE	1.90m	98cm	2	88g	3-14g
NAS68MLFE	2.03m	105cm	2	97g	7-21g
NAS610MFE	2.08m	107cm	2	111g	7-35g
NAS70MHFE	2.13m	110cm	2	120g	14-42g
NAS74MLFE	2.23m	115cm	2	102g	7-21g
NAS78MFE	2.33m	112cm	2	123g	7-35g
NAS710MHFE	2.38m	123cm	2	127g	14-42g
NAS80XHFE	2.44m	125cm	2	154g	28-84g
NAS82HFE	2.49m	128cm	2	150g	21-56g
NAS810MHFE	2.69m	138cm	2	141g	14-42g
NAS90HFE	2.74m	140cm	2	161g	21-56g
NAS90XHFE	2.74m	140cm	2	163g	28-84g

<b>MODERATE - FAST ACTION</b>					
NAS55ULMFC	1.65m	85cm	2	87g	1-7g
NAS611LMFC	2.11m	108cm	2	100g	3-14g
NAS611MMFC	2.11m	108cm	2	109g	7-35g
NAS711MMFC	2.42m	124cm	2	120g	7-35g
NAS711MHMFC	2.42m	124cm	2	121g	14-42g
NAS711HMFC	2.42m	124cm	2	132g	21-56g
NAS810MMFC	2.69m	138cm	2	135g	7-35g
NAS810HMFC	2.69m	138cm	2	170g	21-56g
NAS810XHMFC	2.69m	138cm	2	148g	28-84g
NAS910HMFC	3.00m	153cm	2	166g	21-56g



78MFE



611MMFC





## SEARCH YOUR PERFECT MATCH...

This chart shows the ideal usage for each NASCI rod and reel combination.

FAST-ACTION NASCI ROD MODEL	ROD LENGTH	CASTING WEIGHT (G)	NASCI REEL MODEL	REEL SIZE	PIKE	PERCH	ZANDER	ASPIUS	TROUT	MODERATE-FAST ACTION NASCI ROD MODEL	ROD LENGTH	CASTING WEIGHT (G)	NASCI REEL MODEL	REEL SIZE	PIKE	PERCH	ZANDER	ASPIUS	TROUT
NAS61ULFE	1.85m	1-7g	NAS500FC NAS1000FC	500 1000		•			•	NAS55ULMFC	1.65m	1-7g	NAS500FC NAS1000FC	500 1000		•			•
NAS63LFE	1.90m	3-14g	NASC2000SFC NASC2000SHGFC	C2000S C2000S HG		•			•	NAS611LMFC	2.11m	3-14g	NASC2000SFC NASC2000SHGFC	C2000S C2000S HG		•			•
NAS68MLFE	2.03m	7-21g	NASC2000SHGFC NAS2500SHGFC	C2000S HG 2500S HG		•	•		•	NAS611MMFC	2.11m	7-35g	NAS2500FC NAS2500HGFC	2500 2500 HG		•			•
NAS610MFE	2.08m	7-35g	NAS2500FC NAS2500HGFC	2500 2500 HG	•		•		•	NAS711MMFC	2.42m	7-35g	NAS2500FC NAS2500HGFC	2500 2500 HG		•	•		•
NAS70MHFE	2.13m	14-42g	NASC3000FC NASC3000HGFC	C3000 C3000 HG	•		•		•	NAS711MHMFC	2.42m	14-42g	NASC3000FC NASC3000HGFC	C3000 C3000 HG	•		•		•
NAS74MLFE	2.23m	7-21g	NAS2500SHGFC NAS2500HGFC	2500S HG 2500 HG		•	•		•	NAS711HMFC	2.42m	21-56g	NASC3000FC NASC3000HGFC	C3000 C3000 HG	•		•		•
NAS78MFE	2.33m	7-35g	NAS2500FC NAS2500HGFC	2500 2500 HG	•		•	•	•	NAS810MMFC	2.69m	7-35g	NAS2500FC NAS2500HGFC NASC3000FC NASC3000HGFC	2500 2500 HG C3000 C3000 HG		•	•	•	•
NAS710MHFE	2.38m	14-42g	NASC3000FC NASC3000HGFC	C3000 C3000 HG	•		•		•	NAS810HMFC	2.69m	21-56g	NASC3000FC NASC3000HGFC NAS4000FC NAS4000XGFC	C3000 C3000 HG 4000 4000 XG	•		•		•
NAS80XHFE	2.44m	28-84g	NASC3000FC NASC3000HGFC NAS4000FC NAS4000XGFC	C3000 C3000 HG 4000 4000 XG	•				•	NAS810XHMFC	2.69m	28-84g	NAS4000FC NAS4000XGFC NASC5000XGFC	4000 4000 XG C5000 XG	•				•
NAS82HFE	2.49m	21-56g	NASC3000FC NASC3000HGFC	C3000 C3000 HG	•		•		•	NAS910HMFC	3.00m	21-56g	NAS4000FC NAS4000XGFC NASC5000XGFC	4000 4000 XG C5000 XG	•		•		•
NAS810MHFE	2.69m	14-42g	NASC3000FC NASC3000HGFC NAS4000FC NAS4000XGFC	C3000 C3000 HG 4000 4000 XG	•		•		•										
NAS90HFE	2.74m	21-56g	NASC3000FC NASC3000HGFC NAS4000FC NAS4000XGFC	C3000 C3000 HG 4000 4000 XG	•		•		•										
NAS90XHFE	2.74m	28-84g	NAS4000FC NAS4000XGFC NASC5000XGFC	4000 4000 XG C5000 XG	•				•										

# MATCHING REEL COMBO



NEW

## NEXAVE

- Slim, lightweight and strong Full Carbon blanks
- Split EVA handle models are fast action 2pc rods
- Cork handle models are moderate-fast action 2pcs rods and moderate-fast action 3pcs rods
- Seaguide Stainless Steel XOG anti-tangle guides with Aluminium Oxide linings
- Ergonomic VSS type reel seats
- Graphics and colours match NEXAVE reels

FAST ACTION					
NEX61ULFE	1.85m	97cm	2	84	1-7g
NEX63LFE	1.90m	100cm	2	93	3-14g
NEX68MLFE	2.03m	106cm	2	107	7-21g
NEX610MFE	2.08m	109cm	2	118	7-35g
NEX70MHFE	2.13m	111cm	2	122	14-42g
NEX74MLFE	2.23m	117cm	2	108	7-21g
NEX78MFE	2.34m	122cm	2	125	7-35g
NEX710MHFE	2.39m	125cm	2	135	14-42g
NEX80XHFE	2.44m	127cm	2	161	28-84g
NEX82HFE	2.49m	129cm	2	153	21-56g
NEX810MHFE	2.69m	140cm	2	164	14-42g
NEX90HFE	2.74m	142cm	2	176	21-56g

MODERATE-FAST ACTION					
NEX55ULMFC	1.65m	87cm	2	79	1-7g
NEX611LMFC	2.11m	110cm	2	97	3-14g
NEX611MMFC	2.11m	110cm	2	103	7-35g
NEX711MMFC	2.42m	125cm	2	112	7-35g
NEX711MHMFC	2.42m	125cm	2	125	14-42g
NEX810MMFC	2.69m	139cm	2	138	7-35g
NEX810HMFC	2.69m	139cm	2	156	21-56g
NEX60LMFC3	1.83m	66cm	3	102	3-14g
NEX70MLMFC3	2.13m	77cm	3	117	7-21g
NEX711LMFC3	2.41m	86cm	3	120	3-14g
NEX711MLMFC3	2.41m	86cm	3	124	7-21g
NEX810MLMFC3	2.69m	96cm	3	143	7-21g
NEX810MMFC3	2.69m	96cm	3	153	7-35g
NEX810MHMFC3	2.69m	96cm	3	166	14-42g
NEX910MMFC3	3.00m	106cm	3	171	7-35g
NEX1010HMFC3	3.30m	116cm	3	226	21-56g



610MFE



611LMFC



70MLMFC3



# VERSATILE SPINNING RODS



NEW

FX70MC

## CATANA SPINNING

- Responsive Full Carbon blanks with Geofibre for additional strength
- Fast and Moderate-fast actions to suit wide range of lure fishing styles
- SHIMANO Hardlite Guides for mono and braided lines
- Ergonomic VSS-type reel seat blends perfectly with the modern cosmetics
- Exceptional value for the beginner or less experienced angler

GEOFIBRE

<b>MODERATE-FAST ACTION</b>					
SCATFX55ULC	1.65m	85cm	2	82g	1-11g
SCATFX60LC	1.83m	94cm	2	91g	3-14g
SCATFX60MHJC	1.83m	94cm	2	108g	14-40g
SCATFX70ULC	2.13m	109cm	2	97g	1-11g
SCATFX70MLC	2.13m	109cm	2	102g	7-21g
SCATFX70MC	2.13m	109cm	2	118g	10-30g
SCATFX70MHC	2.13m	109cm	2	127g	14-40g
SCATFX70HC	2.13m	109cm	2	135g	20-50g
SCATFX710ULC	2.39m	122cm	2	108g	1-11g
SCATFX710LC	2.39m	122cm	2	111g	3-14g
SCATFX710MLC	2.39m	122cm	2	129g	7-21g
SCATFX710MC	2.39m	122cm	2	142g	10-30g
SCATFX710MHC	2.39m	122cm	2	145g	14-40g

<b>MODERATE-FAST ACTION</b>					
SCATFX710HC	2.39m	122cm	2	151g	20-50g
SCATFX810LC	2.69m	138cm	2	146g	3-14g
SCATFX810MLC	2.69m	138cm	2	152g	7-21g
SCATFX810MC	2.69m	138cm	2	168g	10-30g
SCATFX810MHC	2.69m	138cm	2	176g	14-40g
SCATFX810HC	2.69m	138cm	2	170g	20-50g
SCATFX810XHC	2.69m	138cm	2	188g	50-100g
SCATFX910MC	3.00m	153cm	2	171g	10-30g
SCATFX910MHC	3.00m	153cm	2	200g	14-40g
SCATFX910HC	3.00m	153cm	2	222g	20-50g
SCATFX910XHC	3.00m	153cm	2	240g	50-100g
<b>FAST ACTION</b>					
SCATFX60LE	1.83m	94cm	2	92g	3-14g
SCATFX70MLE	2.13m	109cm	2	121g	7-21g
SCATFX710ME	2.39m	122cm	2	149g	10-30g
SCATFX710MHE	2.39m	122cm	2	148g	14-40g
SCATFX810MLE	2.69m	138cm	2	163g	7-21g
SCATFX810ME	2.69m	138cm	2	165g	10-30g
SCATFX810MHE	2.69m	138cm	2	164g	14-40g
SCATFX810XHE	2.69m	138cm	3	194g	50-100g



NEW

FXTE24M

# CATANA TELESCOPIC SPINNING

- Telescopic Full Carbon blanks with Geofibre for additional strength
- Short transport length for ultimate transport convenience
- Moderate-fast actions to suit wide range of lure fishing styles
- SHIMANO Hardlite Guides, Ergonomic VSS-type reel seat and cork handle
- Exceptional value as a short-pack second rod for quick sessions



SCATFXTE165UL	1.80m	46cm	2	97g	1-11g
SCATFXTE18L	2.10m	57cm	2	115g	3-14g
SCATFXTE21L	2.10m	61cm	2	125g	3-14g
SCATFXTE21ML	2.10m	61cm	2	129g	7-21g
SCATFXTE21M	2.10m	61cm	2	142g	10-30g
SCATFXTE24ML	2.40m	62cm	2	160g	7-21g
SCATFXTE24M	2.40m	62cm	2	160g	10-30g
SCATFXTE24MH	2.40m	62cm	2	175g	14-40g
SCATFXTE27M	2.70m	69cm	2	203g	10-30g
SCATFXTE27MH	2.70m	69cm	2	213g	14-40g
SCATFXTE30M	3.00m	76cm	2	234g	10-30g
SCATFXTE30MH	3.00m	76cm	2	241g	14-40g
SCATFXTE33H	3.00m	82cm	2	269g	20-50g



# VERSATILE SPINNING / SUPER SENSITIVE RODS



24MC

## VENGEANCE CX

- The Composite blank is reliable, strong and offers excellent performance in its price class
- Moderate-fast action produces good casting performance combined with sensitivity in the tip
- SHIMANO Hardlite guides suitable for both braid and mono
- Available with both Cork and EVA handles
- Exceptional rod for the lure fishing beginner or anglers on a small budget



### CORK HANDLE

SVCX18LC	1.80m	95cm	2	127g	3-15g
SVCX21MLC	2.10m	111cm	2	158g	3-21g
SVCX21MC	2.10m	111cm	2	179g	10-35g
SVCX24MLC	2.40m	126cm	2	210g	3-21g
SVCX24MC	2.40m	126cm	2	228g	10-35g
SVCX24HC	2.40m	126cm	2	219g	20-50g
SVCX27MLC	2.70m	140cm	2	201g	3-21g
SVCX27MC	2.70m	140cm	2	208g	10-35g
SVCX27HC	2.70m	140cm	2	315g	20-50g
SVCX27XHC	2.70m	140cm	2	361g	50-100g
SVCX30HC	3.00m	155cm	2	286g	15-50g

### EVA HANDLE

SVCX18LE	1.80m	95cm	2	123g	3-15g
SVCX21MLE	2.10m	111cm	2	146g	3-21g
SVCX21ME	2.10m	111cm	2	171g	10-35g
SVCX24MLE	2.40m	126cm	2	202g	3-21g
SVCX24ME	2.40m	126cm	2	223g	10-35g
SVCX24HE	2.40m	126cm	2	211g	20-50g
SVCX27MLE	2.70m	140cm	2	196g	3-21g
SVCX27ME	2.70m	140cm	2	202g	10-35g
SVCX27HE	2.70m	140cm	2	316g	20-50g
SVCX27XHE	2.70m	140cm	2	359g	50-100g
SVCX30HE	3.00m	155cm	2	283g	15-50g



24M

## FX XT

- SHIMANO's entry level spinning rod with strong and robust Composite + blank
- Moderate through action helps with casting and offers additional safety when fish-playing
- SHIMANO Hardlite guides suitable for both braid and mono
- EVA handle with secure screw thread DPS reel seat
- Matches perfectly with FX reel making a great combo kit for the inexperienced or young angler



FXXT18L	1.80m	95cm	2	87g	3-14g
FXXT21UL	2.10m	115cm	2	121g	1-11g
FXXT21ML	2.10m	111cm	2	118g	7-21g
FXXT21M	2.10m	111cm	2	116g	10-30g
FXXT21MH	2.10m	111cm	2	123g	14-40g
FXXT24M	2.40m	126cm	2	176g	10-30g
FXXT24MH	2.40m	126cm	2	189g	14-40g
FXXT27M	2.70m	140cm	2	221g	10-30g
FXXT27MH	2.70m	140cm	2	226g	14-40g
FXXT27H	2.70m	140cm	2	240g	20-50g
FXXT27XH	2.70m	140cm	2	256g	50-100g



# SUPER SENSITIVE



70ULPS2

## ZODIAS SUPER SENSITIVE

- Special super sensitive Zodias models for finesse lure applications
- Custom designed extra fast rod actions
- Carbon Monocoque rear grip for extreme sensitivity
- Extremely sensitive solid tips to register even the smallest bites
- Custom Ci4+ reel seat for secure reel support
- Fuji SiC Stainless type guides



21ZODIAS70ULPS2	2.13m	110cm	2	92g	0.5-5g
21ZODIAS74LPS2	2.23m	115cm	2	100g	2.5-11g
21ZODIAS74MLPS2	2.23m	115cm	2	100g	3.5-14g
21ZODIAS80ULPS2	2.44m	125cm	2	102g	1.5-7g
21ZODIAS80MLPS2	2.44m	125cm	2	105g	3.5-14g
21ZODIAS82MPS2	2.49m	127cm	2	117g	4.5-21g



21ULSSC

## VENGEANCE CX SENSITIVE

- Strong, low diameter, fast actioned Full Carbon blank with solid tip construction for increased sensitivity
- Specifically designed for smaller predators like perch, trout and chub using small lightweight lures
- SHIMANO Stainless Steel Hardlite guides
- SHIMANO DPS screw down reel seat with integrated in cork front grip
- Modern cork split grip handle finished with durable rubbercork ends to reduce accidental damage
- Exceptional value for money for a specialised rod

SVCX21ULSSC	2.10m	110cm	2	106g	0.5-7g
SVCX21LSSC	2.10m	110cm	2	109g	1-10g
SVCX21MLSSC	2.10m	110cm	2	112g	3-15g
SVCX24MLSSC	2.40m	125cm	2	137g	3-15g
SVCX24MSSC	2.40m	125cm	2	148g	5-20g
SVCX27MLSSC	2.70m	140cm	2	174g	3-15g







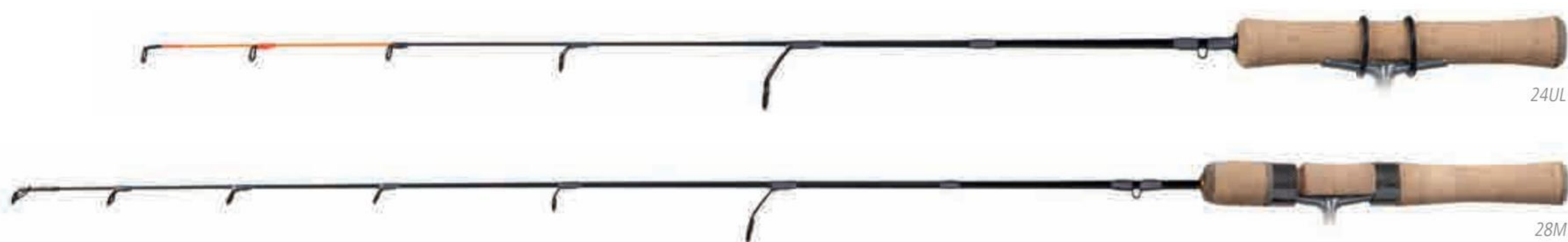

# ICE FISHING



## SEDONA

- Composite carbon blanks with parabolic actions
- Perfect for North and Eastern European ice fishing
- Aluminium Oxide guides
- High quality cork handles
- UL-ML rods have no reel seat, M-MH have DPS-Type reel seat
- 24" and 34" rods match perfectly with SEDONA 500 size reels
- 36" and 40" rods match perfectly with SEDONA 1000 size reels

					
SDSE24UL	61cm		1	-	-
SDSE26L	66cm		1	-	-
SDSE28M	71cm		1	-	-
SDSE28MH	71cm		1	-	-
SDSE28ML	71cm		1	-	-
SDSE30UL	76cm		1	-	-
SDSE34ML	86cm		1	-	-
SDSE36M	91cm		1	-	-
SDSE40MH	101cm		1	-	-







28MLA

## SIENNA

- Composite carbon blanks with parabolic actions
- Perfect for North and Eastern European ice fishing
- Aluminium Oxide guides
- EVA handle with DPS-Type reel seat
- UL-ML rods have no reel seat, M-MH have DPS-Type reel seat
- 24" and 32" rods match perfectly with SIENNA 500 size reels
- 36" and 40" rods match perfectly with SIENNA 1000 size reels

SNSI24ULA	61cm	1	-	-
SNSI26LA	66cm	1	-	-
SNSI28MA	71cm	1	-	-
SNSI28MHA	71cm	1	-	-
SNSI28MLA	71cm	1	-	-
SNSI28ULA	76cm	1	-	-
SNSI32MLA	86cm	1	-	-
SNSI36MA	91cm	1	-	-
SNSI40MHA	101cm	1	-	-





## TROUT RODS

Trout are one of the most widespread and diverse species in Europe. From natural fish in wild mountain streams, to stocked fish in stillwaters, there are many techniques associated with fishing for trout.

The SHIMANO range of trout rods covers all eventualities, from ultra light Trout Area models to telescopic models designed for stillwater competition anglers.





**TROUT NATIVE**

156 TROUT NATIVE

**TROUT AREA**

158 TECHNIUM TROUT AREA

FORCEMASTER TROUT AREA

**TROUT POND**

159 BEASTMASTER CX TROUT / ZANDER

VENGEANCE AX TROUT / ZANDER



# COMPLETE NEW SPECIALIST RANGE



## *Trout Native*

- Lightweight and sensitive High Modulus Full Carbon + HPC+ Nanosheet blanks with metallic forest green finish
- Special progressive action with fast and moderate fast action tapers
- Fuji Alconite K-Type (80MH and 86H models) or KL-Type long frame guides
- Traditional full cork handle with Seaguide XVS reel seat and metal resonator collar
- Perfect colour and performance match with the Cardiff Ci4+ reel

TNSPF66UL	1.98m	102cm	2	96g	1-8g
TNSPMF70ULP	2.13m	109.5cm	2	111g	2-10g
TNSPF70LP	2.13m	109.5cm	2	112g	5-15g
TNSPMF76L	2.28m	117.5cm	2	118g	3-12g
TNSPF76ML	2.28m	117.5cm	2	122g	7-21g
TNSPF80M	2.44m	125cm	2	144g	5-25g
TNSPF80MH	2.44m	125cm	2	152g	15-40g
TNSPMF86MP	2.59m	133cm	2	144g	10-30g
TNSPF86H	2.59m	133cm	2	186g	15-60g





66UL

#### **TNSPF66UL**

The ideal rod to fish on small mountain streams or creeks with both micro hardbaits and softbaits. The fast action allows accurate casting and effective twitching of micro jerkbait minnows and softbaits, in addition to classic trout spoons and spinners. The SPECIAL PROGRESSIVE blank curve and the UL power help to keep a constant contact when fighting the fish even with a barbless single hook.

#### **TNSPMF70ULP**

With its 213cm, moderate-fast action and UL+ power, this rod is developed to fish with traditional lightweight hardbaits (spinners, spoons or minnows) on streams, creeks or small lakes. The special action makes it also ideal for barbless single hook use.

#### **TNSPF70LP**

Versatile 213cm rod developed to fish with both hardbaits and softbaits up to 15g of weight on medium sized streams and rivers. The fast action allows accurate casting and effective twitching of micro jerkbait minnows and softbaits, in addition to classic trout spoons and spinners.

#### **TNSPMF76L**

With a 228cm length, moderate-fast action and light power, this model is capable of handling lures up to 12g. Developed to fish with hardbaits in medium sized streams, rivers or lakes. The additional length helps to control light lures at longer distances when compared to a shorter rod. The special progressive moderate-fast taper guarantees excellent control of the fish, even with a barbless single hook.

#### **TNSPF76ML**

This 228cm rod is specifically developed to fish on a wide range of venues with the more modern trout lure fishing techniques. The fast action taper is perfect for twitching jerkbait minnows, metal-vib lures and softbaits up to 21g. The strong progressive action has plenty of backbone to control larger trout in stronger currents.

#### **TNSPF80M**

A versatile 244cm fast action rod capable of handling hardbaits and softbaits up to 25g in weight. Ideal for fishing medium sized rivers and streams with a moderate current.

#### **TNSPF80MH**

A strong, fast tip action with medium-heavy casting power up for lures up to 40g: The 244cm blank has been developed to control heavier twitchbait minnows, softbaits and metal lures in moderate and strong currents.

#### **TNSPMF86MP**

With its 259cm length, moderate-fast action and casting power of up to 30g, this is the ideal rod to control medium weight trout hardbaits at distance. Perfect for wide lowland rivers and lakes. Excellent lipless minnow and spoon rod, the special progressive curve ensures good casting performance and optimal fish-playing.

#### **TNSPF86H**

Specifically developed to cast and handle the heaviest lures, in the strongest currents. The powerful fast action blank is fitted with a 30mm Fuji K-series starter guide and has a 60g lure rating. The perfect rod for trophy sized trout throughout Europe.

# TROUT RODS



## TECHNIUM TROUT AREA

- Ultra thin High Modulus Full Carbon blank which is highly responsive and designed for casting lightweight lures as small as 0.5g
- Fuji Alconite KR-Type guides for thin braid and light mono lines
- High quality cork handle
- Perfect Ultra Light/Slow action for casting ultralight spoons and cranks and assured fish-playing

STECTA185SUL	1.85m	95.5cm	2	70	0.5-3g
STECTA185UL	1.85m	95.5cm	2	72	1.5-4.5g
STECTAC185UL	1.85m	95.5cm	2	72	1.5-3.5g
STECTA195SUL	1.95m	100.5cm	2	73	0.5-3g
STECTA195UL	1.95m	100.5cm	2	73	1.5-4.5g



## Force Master TROUT AREA

- Slim, Full Carbon blank with parabolic action
- Well balanced rod with Pac Bay reel seat
- Ergonomic EVA Split grip
- Made for fishing with small spoons, roll swimmers and small cranks
- Entry level for trout area fishing

SFMTA185SUL	1.85m	96cm	2	72g	0.5-3.5g
SFMTA185UL	1.85m	96cm	2	76g	1.5-5g
SFMTA195SUL	1.95m	101cm	2	77g	0.5-3.5g
SFMTA195UL	1.95m	101cm	2	79g	1.5-5g









330CX

## Beast Master CX TROUT / ZANDER

- Full Carbon + HPC+ Biofibre blank in 3 section design
- SHIMANO Stainless Steel Hardlite guides
- Custom designed reel seat and cork handle

					
BMCXTRZ300	3.00m	105cm	3	194g	5-40g
BMCXTRZ330	3.30m	115cm	3	195g	5-40g
BMCXTRZ360	3.60m	125cm	3	233g	5-40g



330AX

## VENGEANCE AX TROUT / ZANDER

- Composite blank with a sensitive, fast tip action
- Multi purpose rod for both zander and trout fishing
- Slim IPSA-type reel seat
- Cork handle

					
VAXTRZ300	3.00m	105cm	3	185g	5-40g
VAXTRZ330	3.30m	114cm	3	206g	5-40g
VAXTRZ360	3.60m	125cm	3	231g	5-40g





## TRAVEL RODS

The range of SHIMANO Travel Concept (S.T.C.) rods has been designed to offer ease of transport with exceptional performance.

Covering a wide range of fishing styles, the S.T.C. rods are not only perfect for long haul travel by air, they are perfect for anglers who want a day-to-day easy transport solution for cars, bikes, and public transport.

All of the S.T.C. rods come with a protective transport case that enables the rod to be transported with the reel in place.







**FRESHWATER S.T.C. (MOD-FAST ACTION)**

162 S.T.C. SPINNING

S.T.C. DUAL TIP

S.T.C. MINI TELESPIIN

**FRESHWATER/ SALTWATER S.T.C. (FAST ACTION)**

163 S.T.C. MULTI SPIN

S.T.C. BAITCASTING **NEW**

S.T.C. SPINNING **NEW**

**SALTWATER S.T.C.**

164 S.T.C. SURF

165 S.T.C. MONSTER

S.T.C. POWERGAME

166 S.T.C. SHORE BOAT

167 S.T.C. BOAT



# FRESHWATER S.T.C. RODS



24M

## FRESHWATER: MOD - FAST ACTION

### STC SPINNING

- Full Carbon + Nanosheet blank produces a fast action ideal for a wide range of spinning styles
- SHIMANO custom designed DPS reel seat with high quality abbreviated cork handle
- Single leg SHIMANO Hardlite guides

#### NANOSHEET

STCSPIN24M	2.40m	64cm	4	128g	10-30g
STCSPIN24H	2.40m	64cm	4	142g	20-60g
STCSPIN24XH	2.40m	64cm	4	153g	50-100g
STCSPIN27MH	2.70m	58cm	5	184g	15-40g
STCSPIN27H	2.70m	58cm	5	196g	20-60g
STCSPIN27XH	2.70m	58cm	5	216g	50-100g
STCSPIN30H	3.00m	65cm	5	229g	20-60g



HXH2521

## FRESHWATER: MOD - FAST ACTION

### STC DUAL TIP

- High Modulus Full Carbon blank + Nanosheet blank produces an extra fast action
- Twin Tip design offers unbeatable versatility of action
- Fuji DPS reel seat with cork handle
- Single leg SHIMANO Hardlite guides

#### NANOSHEET

STCDTMLMH2521	2.50/210m	57cm	5 (2 tips)	143/149g	7-21/14-40g
STCDTHXH2521	2.50/210m	57cm	5 (2 tips)	168/176g	20-50/50-100g



S21M

## FRESHWATER: MOD - FAST ACTION

### STC MINI TELESPIN

- Full Carbon blank produces a versatile moderately fast action
- Remarkable short pack length for very easy transport
- SHIMANO custom designed DPS reel seat with high quality cork handle
- Single leg SHIMANO Hardlite guides

#### NANOSHEET

STCMTS18L	1.80m	30cm	10	82g	3-14g
STCMTS18ML	1.80m	30cm	10	85g	7-21g
STCMTS21ML	2.10m	35cm	10	98g	7-21g
STCMTS21M	2.10m	35cm	10	103g	10-30g
STCMTS24L	2.40m	40cm	11	126g	3-14g
STCMTS24M	2.40m	40cm	11	128g	10-30g
STCMTS27ML	2.70m	40cm	11	150g	7-21g
STCMTS27M	2.70m	40cm	11	152g	10-30g



**FRESHWATER: MOD - FAST ACTION**

2427MH

# STC MULTI SPIN

- Full Carbon + Nanosheet blank produces a fast action ideal for a wide range of spinning styles
- Multi-length design for increased versatility
- SHIMANO custom designed DPS reel seat with high quality abbreviated cork handle
- Single leg SHIMANO Hardlite guides

**NANOSHEET**

STCSPIN2124L	2.10/2.40m	53cm	6	115/123g	3-14g
STCSPIN2124M	2.10/2.40m	53cm	6	129/142g	10-30g
STCSPIN2427L	2.40/2.70m	60cm	6	131/146g	3-14g
STCSPIN2427MH	2.40/2.70m	60cm	6	159/178g	15-40g
STCSPIN2730ML	2.70/3.00m	65cm	6	152/179g	5-25g
STCSPIN2730H	2.70/3.00m	65cm	6	183/207g	20-60g
STCSPIN2730XH	2.70/3.00m	65cm	6	192/221g	50-100g



**FRESHWATER / SALTWATER: FAST ACTION**

**NEW**

SPINF70M

# STC SPINNING

- Fast action Nanosheet Carbon blanks
- SHIMANO Hardlite guides for braid and mono lines
- SHIMANO custom design reel seats
- Split grip EVA handles
- Protective transport case with reel pouch for made-up transport

**NANOSHEET**

STCSPINF70ML	2.13m	-	4	-	5-15g
STCSPINF70M	2.13m	-	4	-	7-28g
STCSPINF76MH	2.29m	-	4	-	14-42g
STCSPINF80H	2.44m	-	4	-	15-56g
STCSPINF96XH	2.89m	-	4	-	28-84g



**FRESHWATER / SALTWATER: FAST ACTION**

**NEW**

CASTF70MH

# STC BAITCASTING

- Fast action Nanosheet Carbon blanks
- SHIMANO Hardlite guides for braid and mono lines
- SHIMANO custom design reel seats
- Split grip EVA handles
- Protective transport case with reel pouch for made-up transport

**NANOSHEET**

STCCASTF70MH	2.13m	-	4	-	14-42g
STCCASTF76XXH	2.29m	-	4	-	15-56g

# 6 PART TRAVEL ROD



425BXH

SALTWATER: SURF

## STC SURF

- High Modulus Full Carbon + Nanosheet blank offering immense power and strength ideal for long range surfcasting
- Six section design for easy transport
- Special shrink tube handle with cross grip tape for extra sure handling
- SHIMANO DPS reel seat (425 BX-H) for surf casting/ big pit reels and SHIMANO Slide 'n Grip adjustable reel seat (130M) for multiplier reels
- Seaguide guides for extra strength
- Supplied with strong travel tube for international travel

### NANOSHEET

					
STCSF425BXH	4.25m	76cm	6	686g	225g
STCSF130M	3.96m	71cm	6	775g	225g





24

SALTWATER: INSHORE / OFFSHORE LURE CASTING

## STC MONSTER

- Full Carbon + HPC blank with a moderately fast action
- Imense power and strength ideal for saltwater big game fish
- SHIMANO custom designed DPS reel seat with EVA handle
- Double leg SHIMANO Hardlite guides for extra strength

STCM024	2.40m	66cm	4	271g	28-110g
STCM0315	3.15m	69cm	5	323g	28-110g



2520

SALTWATER: INSHORE / OFFSHORE LURE CASTING

## STC POWERGAME

- Full Carbon + Nanosheet + Biofibre blank with extra fast action
- Immense power and strength ideal for saltwater big game fish
- Fuji DPS reel seat with EVA handle
- Double leg SHIMANO Hardlite guides for extra strength
- Multi-length design for increased versatility, the shorter length (2.00m) is a powerhouse for deep water boat fishing, the longer length (2.40m) makes an excellent rod for casting large lures

STCDTPOB02520	2.40/2.00m	55cm	5 (2 tips)	216/227g	40-120/150-300g



# SUPER COMPACT



SALTWATER: INSHORE / OFFSHORE LURE CASTING

## STC SHORE BOAT

- Full Carbon + Nanosheet + Biofibre blank with extra fast action
- Immense power and strength ideal for saltwater big game fish
- Fuji DPS reel seat with EVA handle
- Double leg SHIMANO Hardlite guides for extra strength
- Multi-length design for increased versatility, can be used from a boat (2.40m) or the shore (3.00m)

NANOSHEET BIOFIBRE

STCDTSHB03024







3.00/2.40m 65cm 5 (2 tips) 288/308g 28-122/150-300g





# ROBUST TRAVEL ROD

SALTWATER: OFFSHORE

## STC BOAT

- Very strong, fast actioned High Modulus Full Carbon + Nanosheet blank with slim profile designed for saltwater boat spinning methods
- Ideal for a wide range of styles including regular jigging (softbaits, metal jigs, pilk), casting with lures (stickbaits and poppers), light game (trolling with medium sized lures)
- Strong saltwater proof Seaguide Black HERO guides
- Full EVA handle with SHIMANO DPS reel seat

### NANOSHEET

STCBT2030	2.18m	63.5cm	4	486g	20-30lb
STCBT3050	2.18m	63.5cm	4	489g	30-50lb
STCBT240200	2.40m	68cm	4	245g	100-200g
STCBT240300	2.40m	68cm	4	259g	150-300g





## SPECIMEN RODS

SHIMANO specimen rods cover a wide variety of budgets and requirements. Within the TRIBAL rod range there is something for every carp angler. Whether you're looking to cast huge distances with ease, mid-range with pinpoint accuracy or at close range with stealth, you'll find a TRIBAL TX rod to suit your style and budget.







170	TRIBAL TX FEATURES	
172	TRIBAL TX ULTRA	
174	TRIBAL TX-9	
175	TRIBAL TX-7	
	TRIBAL TX-5A	<b>NEW</b>
176	TRIBAL TX-4	
	TRIBAL TX-2	
177	TRIBAL TX-1	
178	TRIBAL TX INTENSITY SPOD & MARKER	
	TRIBAL TX-EXTREME	<b>NEW</b>
	TRIBAL TX-PLUS	<b>NEW</b>
179	TRIBAL TX-A SPOD & MARKER	
<b>MULTI PIECE</b>		
179	TRIBAL TX-1 LITE	

<b>PURIST BARBEL</b>		
180	PURIST BX3	<b>NEW</b>
181	PURIST BX1	<b>NEW</b>



# TRIBAL TX FEATURES

## INTENSITY PERFORMANCE

All TRIBAL TX models feature Intensity actions in addition to the normal range of test curves.

Intensity models have been developed for maximum casting performance and use a range of different carbon blends (depending on price) and advanced tapers, to harness the power of the cast. The handles are also longer (70cm) than standard rods of the same length, to help generate more tip speed during the cast.

Intensity rods have been designed for maximum casting performance using a 3oz (85g) to 5oz (142g) lead, with the optimum weight being 4.5oz (128g).



**THE INTENSITY ACTIONS OF THE DIFFERENT TX ROD RANGES VARY DEPENDING ON MODEL TYPE. BELOW IS A GUIDE TO THE CASTING AND FISH-PLAYING PERFORMANCE YOU CAN EXPECT FROM EACH MODEL RATED OUT OF 5 FOR EACH CATEGORY.**

### TX-ULTRA

The TX Ultra is built using SHIMANO's very best carbon technology. This produces the ultimate in casting rod performance combined with exceptional fish-playing performance.

**Casting performance - 5**

**Fish-playing - 5**

### TX-7

TX-7 holds a casting world record for an 'off-the-shelf' carp rod. Immensely powerful, this powerhouse of a rod does sacrifice a bit of playing action to get the immense distance.

**Casting performance - 5**

**Fish-playing - 3**

### TX-4

TX-4 is an animal and rated by some as the best distance/cost ratio available. The playing action isn't the most sophisticated, but if you want to hit the horizon, this could be the model for you.

**Casting performance - 5**

**Fish-playing - 2**

### TX-9

The TX-9 is potentially a world beater when it comes to distance performance. Slightly more power than the Ultra whilst retaining a very acceptable fish-playing action.

**Casting performance - 5**

**Fish-playing - 4**

### TX-5

TX-5 is a fantastic all round casting rod which combines distance potential with a pleasing fish-playing action.

**Casting performance - 3**

**Fish-playing - 4**

### TX-2

TX-2 offers outstanding value for money and is SHIMANO's largest selling carp rod. The Intensity version delivers great distance and has a surprisingly pleasing playing action. For the money you won't get better.

**Casting performance - 4**

**Fish-playing - 3**

## TEST CURVES - LENGTHS, STRENGTHS & PERFORMANCE

The figures in the table are for a TRIBAL TX 2 rod and are actual distances measured by Mike Dagnall (one of the UK's longest casters), using a Big Pit 14000 reel with a 50lb shockleader, tied to 0.31mm (10lb) Aero Carp mono and no rig.

You can see from the results how the test curve rating (and length) relates to the maximum performance for each given lead weight, with the 'sweet spot' for maximum distance being between 3oz (85g) to 4oz (113g).

Look out for the test curve charts throughout the rest of the TRIBAL range.

TX-2 TEST CURVE	CASTING WEIGHT						
	2oz 57g	2.5oz 71g	3oz 85g	3.5oz 99g	4oz 113g	4.5oz 128g	5oz 142g
13ft INT	167yds / 153m	172yds / 157m	189yds / 173m	212yds / 194m	210yds / 192m	200yds / 183m	196yds / 179m
13ft 300lb	172yds / 157m	178yds / 163m	203yds / 186m	200yds / 183m	192yds / 176m	185yds / 169m	170yds / 155m
12ft 325lb	162yds / 148m	169yds / 155m	176yds / 161m	189yds / 173m	187yds / 171m	178yds / 163m	142m
12ft 300lb	155yds / 142m	163yds / 149m	168yds / 154m	163yds / 149m	156yds / 143m	149yds / 136m	-
12ft 275lb	139yds / 127m	145yds / 133m	156yds / 143m	149yds / 136m	142yds / 130m	-	-
11ft 275lb	130yds / 119m	135yds / 123m	142yds / 130m	140yds / 128m	130yds / 119m	-	-
10ft 300lb	129yds / 118m	139yds / 127m	155yds / 142m	138yds / 126m	-	-	-
9ft 300lb	135yds / 123m	143yds / 131m	140yds / 128m	-	-	-	-

# REEL SEATS & HANDLES

SHIMANO carp rod reel seats are designed and selected to perform to the maximum efficiency, whilst retaining an aesthetically pleasing profile. Handles come in varying styles and include abbreviated EVA, slim shrink tube, Winn Gripp and traditional cork (TX-2) options.



## Ci4+ REEL SEAT

Ultra lightweight custom designed reel seat. Available on the TX-Ultra and TX-9 models.



## FUJI REEL SEAT

Recognised as a market leader, Fuji DPS reel seats are used on the TX-7 models.



## SHIMANO REEL SEAT

The highly attractive SHIMANO woven carbon reel seat is used on the TX-4 with a plain version used on the TX-2.

# GUIDES

The use of quality guides on a carp rod is very important for reducing line friction when casting and preventing tangles. SHIMANO carp rods feature Kigan or Seaguide guides. The use of 50mm butt rings on longer casting rods is widespread and anti-tangle tip guides are a common feature throughout the range.

## KIGAN 3D

Kigan 3D guides are lightweight, strong and have zirconia linings. They can be found on the TX-Ultra (12ft INT & 13ft INT), TX-9 and TX-7 models.



## SEAGUIDE

Seaguide guides offer reliable, friction reducing performance and can be found on the TX-4 and TX-2 models.





# UNRIVALED ACCURACY



## TRIBAL TX ULTRA SHIMANO

- The flagship series in the TRIBAL TX rod family incorporating the most advanced design technology
- Spiral X Core and Hi-Power X combines to produce outstanding casting performance and accuracy
- Carbon Monocoque handle construction for increased stiffness that transfers power faster
- Custom Ci4+ reel seat with ergonomic design for increased grip
- Kigan SS 3D Zirconia guides (50mm starter) with anti-frap tip guide
- Intensity models (INT) offer ground breaking casting performance



TXULA12300	50mm	3.66m	188cm	2	300g	3.00lb
TXULA12325	50mm	3.66m	188cm	2	317g	3.25lb
TXULA12INT	50mm	3.66m	188cm	2	350g	3.50lb+
TXULA13INT	50mm	3.96m	203cm	2	390g	3.50lb+





## TEST CURVES - LENGTHS, STRENGTHS & PERFORMANCE

The figures in the table are actual distances measured, using a Big Pit 14000 reel, tied to 0.31mm Aero Carp mono.

You can see from the results how the test curve rating (and length) relates to the maximum performance for each given lead weight, with the 'sweet spot' for maximum distance being between 3.5oz (99g) to 4.5oz (128g).

TX ULTRA TEST CURVE	CASTING WEIGHT						
	2oz 57g	2.5oz 71g	3oz 85g	3.5oz 99g	4oz 113g	4.5oz 128g	5oz 143g
13ft INT	171yds / 156m	180yds / 164m	193yds / 176m	209yds / 191m	218yds / 199m	220yds / 201m	198yds / 181m
12ft INT	165yds / 151m	172yds / 157m	188yds / 172m	198yds / 181m	207yds / 189m	208yds / 190m	194yds / 177m
12ft 325lb	165yds / 151m	172yds / 157m	174yds / 159m	189yds / 172m	174yds / 159m	166yds / 152m	-
12ft 300lb	150yds / 137m	154yds / 141m	167yds / 153m	176yds / 161m	152yds / 139m	140yds / 128m	-



# IMMENSE POWER



## TRIBAL TX-9 SHIMANO

- Unique Spiral X blank produces immense power and extremely accurate distance casting
- Kigan 3D Zirconia guides
- Ultra lightweight SHIMANO Ci4+ carbon reel seat
- High density EVA handle
- Intensity models (INT) offer ground breaking casting performance and powerful playing action
- SPC model has cork handle



TX9A10300	30mm	3.05m	152cm	2	255g	3lb
TX9A12275	40mm	3.66m	188cm	2	337g	2.75lb
TX9A12300	50mm	3.66m	188cm	2	280g	3lb
TX9A12300SPC	50mm	3.66m	188cm	2	337g	3lb
TX9A12325	50mm	3.66m	188cm	2	355g	3.25lb
TX9A12INT	50mm	3.66m	188cm	2	382g	3.5lb+
TX9A13INT	50mm	3.96m	203cm	2	425g	3.5lb+

TX-9 TEST CURVE	CASTING WEIGHT						
	2oz 57g	2.5oz 71g	3oz 85g	3.5oz 99g	4oz 113g	4.5oz 128g	5oz 142g
13ft INT	155yds / 142m	168yds / 154m	180yds / 164m	209yds / 191m	214yds / 195m	215yds / 196m	199yds / 182m
12ft INT	143yds / 131m	154yds / 141m	168yds / 154m	179yds / 164m	200yds / 183m	190yds / 174m	155yds / 142m
12ft 325lb	162yds / 148m	173yds / 158m	174yds / 159m	186yds / 170m	174yds / 159m	168yds / 154m	-
12ft 300lb	152yds / 139m	154yds / 141m	158yds / 144m	176yds / 161m	155yds / 142m	145yds / 133m	-
12ft 275lb	157yds / 144m	162yds / 148m	169yds / 155m	162yds / 148m	149yds / 136m	-	-
10ft 300lb	132yds / 121m	155yds / 142m	168yds / 154m	152yds / 139m	146yd / 134m	-	-

12275



12300

# TRIBAL TX-7 SHIMANO

- High Modulus Full Carbon + HPC blank enforced with Biofibre
- Kigan Stainless Steel Zirconia guides
- Fuji DPS reel seat
- Thin EVA rear grip
- All models come with a 50mm starter guide
- The 13ft INIT holds World Record in 4oz/114g at 247yds in overhead casting category

	0	W+	9	TC		
TX712275	50mm	3.66m	187cm	2	325g	2.75lb
TX712300	50mm	3.66m	187cm	2	326g	3.00lb
TX712325	50mm	3.66m	187cm	2	373g	3.25lb
TX712INT	50mm	3.66m	187cm	2	399g	3.50lb+
TX713INT	50mm	3.96m	202cm	2	427g	3.50lb+

TX-7 TEST CURVE	CASTING WEIGHT						
	2oz 57g	2.5oz 71g	3oz 85g	3.5oz 99g	4oz 113g	4.5oz 128g	5oz 142g
13ft INT	162yds / 148m	172yds / 157m	184yds / 168m	209yds / 191m	218yds / 199m	219yds / 200m	202yds / 185m
12ft INT	155yds / 142m	172yds / 157m	189yds / 173m	199yds / 182m	204yds / 187m	195yds / 178m	166yds / 152m
12ft 325lb	160yds / 146m	169yds / 155m	173yds / 158m	187yds / 171m	171yds / 156m	165yds / 151m	-
12ft 300lb	150yds / 137m	154yds / 141m	157yds / 144m	174yds / 159m	158yds / 144m	148yds / 135m	-
12ft 275lb	155yds / 142m	160yds / 146m	164yds / 150m	168yds / 154m	146yds / 134m	-	-



10300

NEW

# TRIBAL TX-5A SHIMANO

- Slim, responsive High Pressure Carbon (HPC) Nanosheet blank
- 3K weave for additional strength
- Seaguide Zirconia guides (braid safe) with Anti Frap Tip guide
- Custom 3K Woven Carbon DPS Seat with Winn Grip polymer handle
- Engraved 'Tribal' stainless steel butt cap



TX-5A TEST CURVE	CASTING WEIGHT						
	2oz 57g	2.5oz 71g	3oz 85g	3.5oz 99g	4oz 113g	4.5oz 128g	5oz 142g
13ft INT	153yds / 140m	170yds / 155m	177yds / 162m	201yds / 184m	213yds / 195m	215yds / 197m	201yds / 184m
12ft INT	159yds / 145m	170yds / 155m	188yds / 172m	197yds / 180m	202yds / 185m	194yds / 177m	167yds / 153m
12ft 325lb	148yds / 133m	163yds / 149m	172yds / 157m	184yds / 168m	171yds / 156m	156yds / 143m	-
12ft 300lb	148yds / 133m	150yds / 137m	156yds / 143m	167yds / 153m	151yds / 138m	142yds / 130m	-
12ft 275lb	148yds / 133m	148yds / 135m	154yds / 141m	152yds / 139m	140yds / 128m	-	-
10ft INT	155yds / 142m	164yds / 150m	174yds / 159m	173yds / 158m	166yds / 152m	153yds / 140m	-
10ft 300lb	138yds / 126m	150yds / 137m	166yds / 152m	153yds / 140m	144yds / 132m	-	-
10ft 275lb	136yds / 124m	149yds / 136m	162yds / 148m	149yds / 136m	-	-	-

	0	W+	9	TC		
TX5A10275	50mm	3.05m	156cm	2	-	2.75lb
TX5A10300	50mm	3.05m	156cm	2	243g	3.00lb
TX5A10INT	50mm	3.05m	156cm	2	273g	3.50lb+
TX5A12275	50mm	3.66m	187cm	2	-	2.75lb
TX5A12300	50mm	3.66m	187cm	2	375g	3.00lb
TX5A12325	50mm	3.66m	187cm	2	410g	3.25lb
TX5A12INT	50mm	3.66m	187cm	2	407g	3.50lb+
TX5A13INT	50mm	3.96m	202cm	2	451g	3.50lb+

# TRIBAL RODS



12275

## TRIBAL TX-4 SHIMANO

- Range now extended with models ranging from 9' length 3.0lb for stalking and 10' length for boat and short range fishing, through to 13' length Intensity for long range casting
- A powerful Full Carbon + HPC + Biofibre blank
- Seaguide Stainless Steel SIC guides
- SHIMANO Woven Carbon DPS with small front EVA grip
- Slim shrink grip handle with in-built rest stopper



TX49300 STALKER	40mm	2.74m	141cm	2	217g	3.00lb
TX410275	40mm	3.05m	156cm	2	243g	2.75lb
TX410300	40mm	3.05m	156cm	2	257g	3.00lb
TX410325	40mm	3.05m	156cm	2	270g	3.25lb
TX412275	50mm	3.66m	187cm	2	299g	2.75lb
TX412300	50mm	3.66m	187cm	2	341g	3.00lb
TX412325	50mm	3.66m	187cm	2	369g	3.25lb
TX412INT	50mm	3.66m	187cm	2	409g	3.50lb+
TX413INT	50mm	3.96m	202cm	2	460g	3.50lb+

TX-4 TEST CURVE	CASTING WEIGHT						
	2oz 57g	2.5oz 71g	3oz 85g	3.5oz 99g	4oz 113g	4.5oz 128g	5oz 142g
13ft INT	145yds / 133m	167yds / 153m	174yds / 159m	195yds / 178m	211yds / 193m	210yds / 192m	202yds / 185m
12ft INT	162yds / 148m	175yds / 160m	190yds / 174m	199yds / 182m	203yds / 186m	197yds / 180m	170yds / 155m
12ft 325lb	141yds / 129m	159yds / 145m	170yds / 155m	181yds / 166m	172yds / 157m	152yds / 139m	-
12ft 300lb	142yds / 130m	147yds / 134m	158yds / 144m	160yds / 146m	145yds / 133m	-	-
12ft 275lb	142yds / 130m	144yds / 132m	153yds / 140m	144yds / 132m	-	-	-
10ft 325lb	154yds / 141m	162yds / 148m	169yds / 155m	169yds / 155m	159yds / 146m	143yds / 131m	-
10ft 300lb	128yds / 117m	148yds / 135m	165yds / 151m	152yds / 139m	153yds / 140m	-	-
10ft 275lb	134yds / 123m	146yds / 134m	158yds / 144m	142yds / 130m	-	-	-
9ft 300lb	140yds / 128m	150yds / 137m	141yds / 129m	-	-	-	-



12300SPC

## TRIBAL TX-2 SHIMANO

- High Modulus Full Carbon blank with slim profile and progressive action for excellent casting performance
- Seaguide Zirconia guides (50mm starter guide on longer models)
- SHIMANO DPS reel seat
- Slim shrink tube or cork handle options
- Application models for stalking and floater fishing



### CORK HANDLE

TX210300SPC	40mm	3.05m	157cm	2	328g	3.00lb
TX212275SPC	50mm	3.66m	187cm	2	350g	2.75lb
TX212300SPC	50mm	3.66m	187cm	2	371g	3.00lb
TX212325SPC	50mm	3.66m	187cm	2	433g	3.25lb
TX213INTSPC	50mm	3.96m	202cm	2	470g	3.50lb+

SHRINK TUBE HANDLE						
TX29300 STALKER	30mm	2.74m	141cm	2	236g	3.00lb
TX210275	30mm	3.05m	157cm	2	276g	2.75lb
TX210300	40mm	3.05m	157cm	2	317g	3.00lb
TX211275	40mm	3.35m	167cm	2	321g	2.75lb
TX2FL12200 FLOATER	30mm	3.66m	187cm	2	278g	2.00lb
TX212275	50mm	3.66m	187cm	2	338g	2.75lb
TX212300	50mm	3.66m	187cm	2	363g	3.00lb
TX212325	50mm	3.66m	187cm	2	434g	3.25lb
TX213300	50mm	3.96m	202cm	2	441g	3.00lb
TX212INT	50mm	3.66m	187cm	2	423g	3.50lb+
TX213INT	50mm	3.96m	202cm	2	445g	3.50lb+

TX-2 TEST CURVE	CASTING WEIGHT						
	2oz 57g	2.5oz 71g	3oz 85g	3.5oz 99g	4oz 113g	4.5oz 128g	5oz 142g
13ft INT	167yds / 153m	172yds / 157m	189yds / 173m	212yds / 194m	210yds / 192m	200yds / 183m	196yds / 179m
13ft 300lb	172yds / 157m	178yds / 163m	203yds / 186m	200yds / 183m	192yds / 176m	185yds / 169m	170yds / 155m
12ft 325lb	162yds / 148m	169yds / 155m	176yds / 161m	189yds / 173m	187yds / 171m	178yds / 163m	142m
12ft 300lb	155yds / 142m	163yds / 149m	168yds / 154m	163yds / 149m	156yds / 143m	149yds / 136m	-
12ft 275lb	139yds / 127m	145yds / 133m	156yds / 143m	149yds / 136m	142yds / 130m	-	-
11ft 275lb	130yds / 119m	135yds / 123m	142yds / 130m	140yds / 128m	130yds / 119m	-	-
10ft 300lb	129yds / 118m	139yds / 127m	155yds / 142m	138yds / 126m	-	-	-
9ft 300lb	135yds / 123m	143yds / 131m	140yds / 128m	-	-	-	-



# GREAT CASTING



## TRIBAL TX-1A SHIMANO

- Responsive Full Carbon blank offers excellent performance to price ratio for the budget conscious angler
- Seaguide Zirconia guides (50mm starter guide on longer models)
- SHIMANO DPS reel seat
- Slim shrink EVA or cork handle options
- Full range available from 9' length 3.0lb for stalking and 10' length for boat and short range fishing, through to 13' length Intensity for long range casting

TX1A9300 STALKER	30mm	2.74m	142cm	2	250g	3.00lb
TX1A10300	40mm	3.05m	158cm	2	310g	3.00lb
TX1A12275	40mm	3.66m	188cm	2	382g	2.75lb
TX1A12300	50mm	3.66m	188cm	2	424g	3.00lb
TX1A12325	50mm	3.66m	188cm	2	395g	3.25lb
TX1A12INT	50mm	3.66m	188cm	2	422g	3.50lb+
TX1A13INT	50mm	3.96m	203cm	2	480g	3.50lb+
TX1A113003	40mm	3.35m	116cm	3	366g	3.00lb
TX1A123003	50mm	3.66m	127cm	3	413g	3.00lb
TX1A12INT3	50mm	3.66m	127cm	3	430g	3.50lb+
TX1A13INT3	50mm	3.96m	137cm	3	470g	3.50lb+
<b>CORK HANDLE</b>						
TX1A12300SPC	50mm	3.66m	191cm	2	406g	3.00lb
TX1A12325SPC	50mm	3.66m	191cm	2	355g	3.25lb
TX1A13INTSPC	50mm	3.96m	207cm	2	455g	3.50lb+



# TRIBAL RODS



12

## TRIBAL TX-INTENSITY SPOD & MARKER SHIMANO

- Exclusive Spiral X Core blank construction removes blank twist and ovalisation for extremely powerful, accurate casting
- Futuristic design compliments TX-ULTRA and TX-9 rods
- SHIMANO Ci4+ reel seat
- High quality Double leg Kigan 3D Zirconia guides throughout
- Extreme low weight blanks for increased tip speed and distance with baiting devices
- 5.0lb test curve will cope with the largest spods



TXINTSPODMRK12	50mm	3.66m	188cm	2	344g	5.00lb
TXINTSPODMRK13	50mm	3.96m	203cm	2	412g	5.00lb



ESM13500

NEW

## TRIBAL TX-EXTREME SPOD & MARKER SHIMANO

- Full carbon High Pressure Carbon (HPC) blank
- 3K weave for additional strength casting the largest spods
- Seaguide Zirconia guides (braid safe) with large anti-rap tip guide
- SHIMANO DPS reel seat with EVA handle
- Engraved 'Tribal' stainless steel butt cap



TXESM12500	50mm	3.66m	187cm	2	393g	5.00lb
TXESM13500	50mm	3.96m	203cm	2	418g	5.00lb



PSM13500

NEW

## TRIBAL TX-PLUS SPOD & MARKER SHIMANO

- Full carbon blank for long range casting
- Seaguide guides (braid safe) with large anti-frap tip guide
- Depth marker wraps for accurate measuring
- SHIMANO DPS reel seat with EVA handle
- Engraved 'Tribal' stainless steel butt cap

TXPSM12500	50mm	3.66m	187cm	2	434g	5.00lb
TXPSM13500	50mm	3.96m	203cm	2	454g	5.00lb



## TRIBAL SHIMANO TX-A SPOD & MARKER

- Full Carbon blank is stiff, powerful and responsive - the ideal action to cast extreme distances with spods, spombs and marker floats
- Spod models have 5lb test curve for casting heavy spods, Marker models have 3lb test curve for long range marker float casting
- Seaguide Stainless SIC guides (50mm starter guide)
- SHIMANO DPS reel seat
- Slim shrink handle with EVA front grip



SPOD						
TXAS12500	50mm	3.66m	188cm	2	502g	5.00lb
TXAS13500	50mm	3.96m	203cm	2	558g	5.00lb
MARKER						
TXAM12300	50mm	3.66m	188cm	2	528g	3.00lb



## TRIBAL SHIMANO TX-1 LITE

9300

- Responsive Full Carbon blank is 4 piece easy to transport design
- Seaguide guides (50mm starter guide on longer models)
- SHIMANO DPS reel seat
- Slim shrink handle with small EVA front grip
- Full range available from 9' length 3.0lb for stalking and 10' length for boat and short range fishing, through to 12' length Intensity for long range casting
- Powerful Blanks that can handle the most aggressive casts
- Size 16 Tip guides on all models that lead clips will pass through for fast set-up
- EVA Spigot collars for a seamless finish



TX1L9300	30mm	2.74m	76cm	4	248	3.00lb
TX1L10300	40mm	3.05m	83cm	4	314	3.00lb
TX1L10INT	40mm	3.05m	83cm	4	323	3.50lb+
TX1L12300	50mm	3.66m	98cm	4	377	3.00lb
TX1L12INT	50mm	3.66m	98cm	4	409	3.50lb+





# FINE TUNED TIP ACTION



BX312225

NEW

## Purist BX3

- Progressive taper full carbon blank with 3K weave for additional power
- Fine tuned tip with white top for enhanced bite detection
- SHIMANO double leg Hardlite guides for strength
- Full cork handle with DPS reel seat
- Alloy butt cap

							
PURBX312175	25mm	3.66m	188cm	2	303g	Max 170g	1.75lb
PURBX312225	25mm	3.66m	188cm	2	320g	Max 200g	2.25lb
PURBX312INT	30mm	3.66m	188cm	2	348g	Max 250g	2.75lb
PURBX313INT	30mm	3.96m	203cm	2	383g	Max 290g	3.00lb



# Purist



BX112175

NEW

## Purist BX1

- Quality full carbon blank with fine tuned tip for enhanced bite detection
- SHIMANO double leg Hardlite guides for strength
- Full cork handle with DPS reel seat
- White painted tip for increased visibility
- Alloy butt cap

						
PURBX112175	25mm	3.66m	188cm	2	276g	Max 170g 1.75lb
PURBX112225	25mm	3.66m	188cm	2	290g	Max 200g 2.25lb
PURBX112INT	30mm	3.66m	188cm	2	329g	Max 250g 2.75lb
PURBX113INT	30mm	3.96m	203cm	2	348g	Max 290g 3.00lb





# MATCH & FEEDER RODS

SHIMANO Match and Feeder rods cover all styles of match and feeder fishing across Europe. With the growth in popularity of feeder fishing, SHIMANO's range covers everything from extreme long range fishing for bream to close range fishing for carp on man-made (Commercial) waters.





**AERO**

184	AERO CONCEPT
186	AERO X7
188	AERO X5
190	AERO X1

**FLOAT**

192	CARP CRUNCHER
	VENGEANCE AX
193	QUIVERTIPS





SHIMANO  
**AERO**

**PRECISION TO WIN**







**Whether you are competing at the very highest level of competition fishing, or just challenging yourself at your local water, SHIMANO AERO ensures you maximise your performance and enhance your enjoyment.**

At the highest level, the difference between success and failure is almost imperceptible. Any edge or advantage, however small, can make a huge difference. That one fish or very last bite, casting a perfect distance, there are so many critical situations. With SHIMANO AERO you can tip the balance in your favour, giving you the very best chance of success.

All SHIMANO AERO products have been fine-tuned for success and made with the precision that you expect from SHIMANO. It's a precision you can see, touch, and feel. A precision that inspires confidence and enables you to enjoy the moment when it matters most.

**Precision to win.**





# ULTRA RESPONSIVE



DR9 Finesse Feeder

## AERO X7 FINESSE FEEDER

- Designed for short and medium range finesse feeder or straight lead fishing
- Super light, strong, ultra responsive High Modulus Carbon + HPC + Nanosheet blanks with parabolic fish-playing action
- Lightweight Fuji Alconite KR guides
- High quality cork handle with EVA rear grip and Fuji VVS reel seat
- 3 complete spliced tip sections, with custom tip guide size



AEX7FFDR9 | 9ft/2.74m | 146cm | 1 + 3 | 137g | 50g | **INC. TIPS** 0.25oz / 0.75oz / 1oz



DR10 Precision Feeder

## AERO X7 PRECISION FEEDER

- Designed for short and medium range feeder or straight lead fishing for carp and silver fish
- Super light, strong, ultra responsive High Modulus Carbon + HPC + Nanosheet blanks with progressive fish-playing action
- Lightweight Fuji Alconite KR guides
- High quality cork handle with EVA rear grip and Fuji VVS reel seat
- 3 complete spliced tip sections, with custom tip guide size



						INC. TIPS
AEX7PRFDR10	10ft/3.05m	161cm	1 + 3	139g	60g	0.5oz / 1oz / 1.25oz
AEX7PRFDR11	11ft/3.35m	176cm	1 + 3	159g	60g	0.75oz / 1oz / 1.5oz



DR12 Distance Feeder

## AERO X7 DISTANCE FEEDER

- Designed for medium and long range feeder fishing
- Super light, strong, ultra responsive High Modulus Carbon + HPC + Nanosheet blanks with fantastic casting performance
- Anti-tangle Kigan 3D Zirconia guides
- High quality cork handle with EVA rear grip and Fuji VVS reel seat
- 3 complete spliced tip sections, with custom tip guide size
- Distance Feeder models have screw-in rear extension grip



						INC. TIPS
<b>DISTANCE FEEDER</b>						
AEX7DFDR12	12ft/3.66m	192cm	1 + 3	183g	90g	1.5oz / 2oz / 2.5oz
AEX7DFDR13	12ft/3.96m	140cm	2 + 3	264g	100g	2oz / 2.5oz / 3oz
<b>DISTANCE POWER FEEDER</b>						
AEX7DPFDR13	13ft/3.96m	140cm	2 + 3	298g	120g	3oz / 4oz / 5oz



Screw-in extension

# EVERYTHING COVERED



PRFDR10

## AERO X5 PRECISION FEEDER

- Designed for short and medium range feeder or straight lead fishing
- Light, responsive and strong High Modulus Carbon + HPC + Nanosheet blanks
- Super light Seaguide XOG anti-tangle guides
- Cork/EVA handle with SHIMANO DPS reel seat
- Supplied with 3 interchangeable carbon quiver tips



						INC. TIPS
AEX5PRFDR10	10ft/3.05m	161cm	2 + 3 tips	139g	60g	0.5oz / 0.75oz / 1oz
AEX5PMFDR911	9ft-11ft 2.74/3.35m	128cm	2 + 3 tips	166g	60g	0.5oz / 0.75oz / 1.5oz



DFDR13

## AERO X5 DISTANCE FEEDER

- Designed for medium and long range feeder fishing
- Responsive and strong High Modulus Carbon + HPC + Nanosheet blanks
- Strong large diameter Seaguide XOG anti-tangle guides for increased casting performance
- Cork/EVA handle with SHIMANO DPS reel seat
- Supplied with 3 interchangeable carbon quiver tips

						INC. TIPS
<b>DISTANCE FEEDER</b>						
AEX5DFDR12	12ft/3.66m	191cm	2 + 3 tips	192g	90g	1.5oz / 2oz / 2.5oz
AEX5DFDR13	13ft/3.96m	140cm	3 + 3 tips	256g	90g	1.5oz / 2oz / 3oz
<b>DISTANCE POWER FEEDER</b>						
AEX5DPFDR13	13ft/3.96m	140cm	3 + 3 tips	331g	120g	3oz / 4oz / 5oz
<b>DISTANCE HEAVY POWER FEEDER</b>						
AEX5DHPFDR13	13ft/3.96m	140cm	3 + 3 tips	334g	150g	3oz / 4oz / 5oz
AEX5DHPFDR14	14ft/4.27m	150cm	3 + 3 tips	362g	150g	3oz / 4oz / 5oz



PW10

## AERO X5 PELLET WAGGLER

- Designed for pellet waggler fishing for carp
- Light, responsive and strong High Modulus Carbon + HPC + Nanosheet blanks with remarkable fish-playing actions
- Seaguide XOG guides - single leg intermediates
- Cork/EVA handle with SHIMANO DPS reel seat



AEX5PW10	10ft/3.05m	157cm	2	130g	15g
AEX5PW11	11ft/3.35m	172cm	2	148g	15g



MF13

## AERO X5 MATCH FLOAT

- Designed for all round float fishing
- Light, responsive High Modulus Carbon + HPC + Nanosheet blanks with fast tip action for increased float control and excellent fish-playing
- Seaguide XOG guides - single leg intermediates
- Cork/EVA handle with SHIMANO DPS reel seat



AEX5MF13	13ft/3.96m	136cm	3	162g	20g
AEX5MF14	14ft/4.27m	147cm	3	175g	20g

# COARSE RODS



## AERO X1 FINESSE / PRECISION FEEDER

- Designed for short and medium range feeder or straight lead fishing
- Full Carbon blanks for lightweight, responsive performance with fantastic fish-playing actions
- Low profile SHIMANO Hardlite guides
- Cork/EVA handle with DPS reel seat
- Supplied with 2 quivertips

						INC. TIPS
<b>FINESSE FEEDER</b>						
AEX1FFDR8	8ft/2.44m	129cm	2 + tips	130g	40g	0.75oz / 1oz
AEX1FFDR9	9ft/2.74m	146cm	2 + tips	145g	60g	1oz / 1.5oz
<b>PRECISION FEEDER</b>						
AEX1PRFDR10	10ft/3.05m	162cm	2 + tips	160g	60g	1oz / 1.5oz
AEX1PRFDR11	11ft/3.35m	171cm	2 + tips	190g	70g	1oz / 2oz

FFDR8



## AERO X1 DISTANCE FEEDER

- Designed for medium and long range feeder fishing
- Full Carbon blanks for responsive actions with excellent casting performance
- SHIMANO Hardlite guides
- Cork/EVA handle with DPS reel seat
- Supplied with 2 quivertips

						INC. TIPS
<b>DISTANCE FEEDER</b>						
AEX1DFDR12	12ft/3.66m	191cm	2 + tips	230g	90g	2oz / 3oz
AEX1DFDR13	13ft/3.96m	140cm	3 + tips	280g	90g	2oz / 3oz
<b>DISTANCE POWER FEEDER</b>						
AEX1DHPFDR13	13ft/3.96m	140cm	3 + tips	330g	120g	3oz / 5oz

DHPFDR13



PW10

## AERO X1 PELLET WAGGLER

- Designed for pellet waggler fishing for carp
- Full Carbon blanks provides semi-parabolic fish-playing action
- SHIMANO Hardlite guides with single leg intermediates
- Cork/EVA handle with DPS reel seat

AEX1PW10	10ft/3.05m	157cm	2	180g	15g
AEX1PW11	11ft/3.35m	172cm	2	200g	15g



MF13

## AERO X1 MATCH FLOAT

- Designed for all round float fishing
- Full Carbon blank for lightweight, responsive performance and excellent float control
- SHIMANO Hardlite guides with single leg intermediates
- Cork/EVA handle with DPS reel seat

AEX1MF13	13ft/3.96m	136cm	3	210g	20g

# FLOAT RODS



FL33

## CARP CRUNCHER FLOAT

- Advanced technology Full Carbon + Nanosheet blanks which are lightweight, slim and very strong
- Specially designed for handling small and mid-sized carp plus larger silver fish like bream, chub and tench
- Strong Seaguide Hero XQG+XOG guides for perfect line management
- Cork/EVA handle with custom reel seat

CRFL33	3.30m	114cm	3	184g	10-30g
CRFL36	3.60m	124cm	3	190g	10-30g
CRFL39	3.90m	134cm	3	239g	20-50g

NANOSHEET



FL39

## VENGEANCE AX FLOAT

- Strong Full Carbon blanks, with power in the butt section to control larger fish
- Seaguide Atlas guides for perfect line-management
- Cork/EVA handle with custom SHIMANO VSS reel seat

VAXFL36	3.60m	124cm	3	210g	10-30g
VAXFL39	3.90m	134cm	3	254g	10-30g





# REPLACEMENT QUIVER TIPS

## AERO X7

	AEX7FFDR9 FINESSE FEEDER 9'0"	AEX7PRFDR10 PRECISION FEEDER 10'0"	AEX7PRFDR11 PRECISION FEEDER 11'0"	AEX7DFDR12 DISTANCE FEEDER 12'0"	AEX7DFDR13 DISTANCE FEEDER 13'0"	AEX7DPFDR13 DISTANCE P FEEDER 13'0"
0.25oz	AEX7FFDR9T1	-	-	-	-	-
0.50oz	-	AEX7PRFDR10T1	-	-	-	-
0.75oz	AEX7FFDR9T2	-	AEX7PRFDR11T1	-	-	-
1.00oz	AEX7FFDR9T3	AEX7PRFDR10T2	AEX7PRFDR11T2	-	-	-
1.25oz	-	AEX7PRFDR10T3	-	-	-	-
1.50oz	-	-	AEX7PRFDR11T3	AEX7DFDR12T1	-	-
2.00oz	-	-	-	AEX7DFDR12T2	AEX7DFDR13T1	-
2.50oz	-	-	-	AEX7DFDR12T3	AEX7DFDR13T2	-
3.00oz	-	-	-	-	AEX7DFDR13T3	AEX7DPFDR13T1
4.00oz	-	-	-	-	-	AEX7DPFDR13T2
5.00oz	-	-	-	-	-	AEX7DPFDR13T3

## AERO X5

	AEX5PRFDR10 PRECISION FEEDER 10'0"	AEX5PMFDR911 PRECISION FEEDER 9'0"-11'0"	AEX5DFDR12 DISTANCE FEEDER 12'0"	AEX5DFDR13 DISTANCE FEEDER 13'0"	AEX5DPFDR13 DISTANCE P FEEDER 13'0"	AEX5DHPFDR13 DISTANCE HP FEEDER 13'0"	AEX5DHPFDR14 DISTANCE HP FEEDER 14'0"
0.25oz	-	-	-	-	-	-	-
0.50oz	AEROTIP050SGSD	AEROTIP050SGSD	-	-	-	-	-
0.75oz	AEROTIP075SGSD	AEROTIP075SGSD	-	-	-	-	-
1.00oz	AEROTIP100SGSD	-	-	-	-	-	-
1.25oz	-	-	-	-	-	-	-
1.50oz	-	AEROTIP150SGSD	AEROTIP150SGSD	AEROTIP150SGLD	-	-	-
2.00oz	-	-	AEROTIP200SGSD	AEROTIP200SGLD	-	-	-
2.50oz	-	-	AEROTIP250NGSD	-	-	-	-
3.00oz	-	-	-	AEROTIP300NGLD	AEROTIP300NGLD	AEROTIP300NGLD	AEROTIP300NGLD
4.00oz	-	-	-	-	AEROTIP400LGLD	AEROTIP400LGLD	AEROTIP400LGLD
5.00oz	-	-	-	-	AEROTIP500LGLD	AEROTIP500LGLD	AEROTIP500LGLD

## AERO X1

	AEX1FFDR8 FINESSE FEEDER 8'0"	AEX1FFDR9 FINESSE FEEDER 9'0"	AEX1PRFDR10 PRECISION FEEDER 10'0"	AEX1PRFDR11 PRECISION FEEDER 11'0"	AEX1DFDR12 DISTANCE FEEDER 12'0"	AEX1DFDR13 DISTANCE FEEDER 13'0"	AEX1DHPFDR13 DISTANCE P FEEDER 13'0"
0.25oz	-	-	-	-	-	-	-
0.50oz	-	-	-	-	-	-	-
0.75oz	AEX1FFDRTIP075	-	-	-	-	-	-
1.00oz	AEX1FFDRTIP10	AEX1FFDRTIP10	AEX1FFDRTIP10	AEX1FFDRTIP10	-	-	-
1.25oz	-	-	-	-	-	-	-
1.50oz	-	AEX1FFDRTIP15	AEX1FFDRTIP15	-	-	-	-
2.00oz	-	-	-	AEX1FFDRTIP20-1112	AEX1FFDRTIP20-1112	AEX1FFDRTIP20-13	-
2.50oz	-	-	-	-	-	-	-
3.00oz	-	-	-	-	AEX1FFDRTIP30-12	AEX1FFDRTIP30-13	AEX1FFDRTIP30-13
4.00oz	-	-	-	-	-	-	-
5.00oz	-	-	-	-	-	-	AEX1FFDRTIP50



## TELESCOPIC RODS

The popularity of fishing with telescopic rods has spread all across Europe and with many different designs now available, from traditional Bolognese fishing to monster models, there is something for everyone in the SHIMANO range



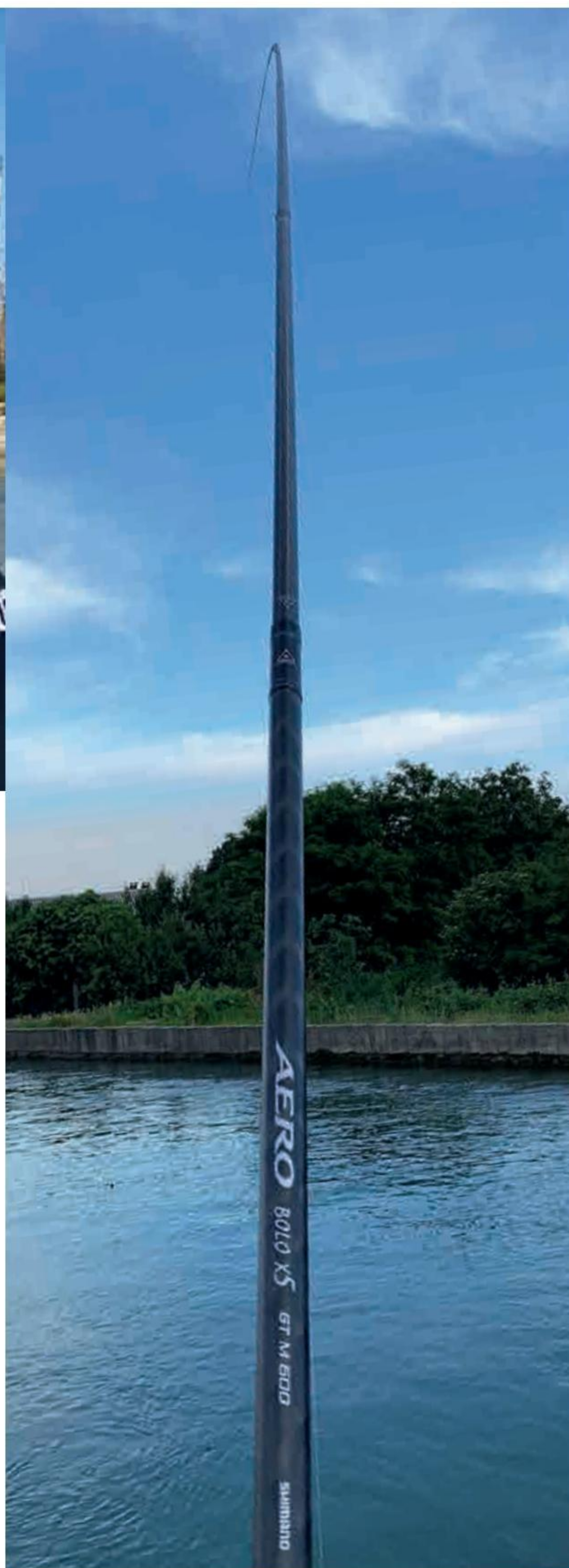

#### TELESCOPIC BOLO

196	ASPIRE BOLO TE SUPER ULTEGRA CATANA EX TE2	
197	AERO X5 BOLO GT	<b>NEW</b>
198	AERO X3 BOLO GT	<b>NEW</b>

#### TELESCOPIC

199	ALIVIO DX TE GT5 CATANA STATIC BAIT	
-----	--	--

#### SLIM TELESCOPIC

200	VENGEANCE SLIM TE GT ALIVIO SLIM TE GT VENGEANCE AX SLIM TE	
201	VENGEANCE ALLROUND ALIVIO ALLROUND	

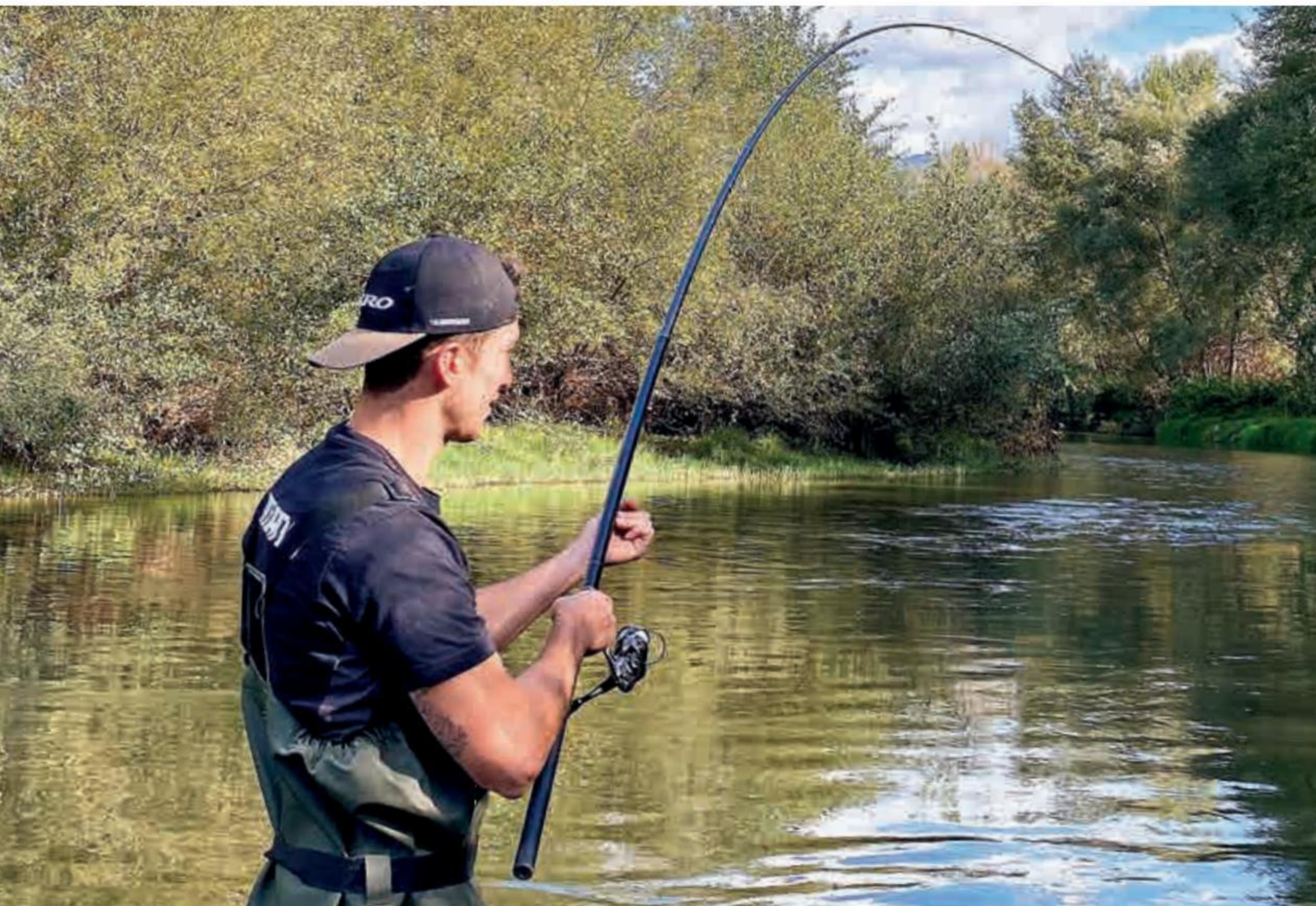

# TELESCOPIC BOLO RODS



M70

## ASPIRE TE

- Utilising advanced Japanese carbon technology
- Spiral X Core blanks provide stiffness and strength while remaining light weight and responsive
- Hi-Power X Tips sections with additional torsional rigidity for increased fish-playing control
- Supplied without guides and reel seat for custom building



ASPI60	5.90m	134cm	6	180g	8-18g
ASPI70	6.90m	134cm	7	235g	8-18g
ASPIH60	5.90m	134cm	6	182g	5-25g
ASPIH70	6.90m	134cm	7	237g	5-25g



M80

## SUPER ULTEGRA MEDIUM / HEAVY

- High Modulus Full Carbon + HPC + Biofibre + Nanosheet blank with varnished end grip
- Softer tip for fine mono lines with additional power in the bottom half for casting and fish-playing performance
- Slim diameter butt section for comfortable and easy handling
- Special rubberised paint grip for assured handling
- No guides or reel seat enable the angler to custom build the rod



SULTM80	8.00m	135cm	8	306g	8-18g
SULTEH80	8.00m	135cm	8	307g	15-125g



EX TE 270

## CATANA EX TE 2

- Lightweight float application (2-8 grams)
- Full Carbon blank
- Available in three sizes ranging from 6m to 8m
- Supplied without guides and reel seat

CATEXTE260	5.90m	135cm	6	205g	2-8g
CATEXTE270	6.90m	135cm	7	260g	2-8g
CATEXTE280	7.90m	135cm	8	340g	2-8g



# SUPER FAST ACTION

NEW

## AERO X5 BOLO GT

- Slim Full Carbon HPC blanks reinforced with Biofibre
- Diaflash construction for extra strength on the handle section
- Seaguide XOG lightweight guides
- SHIMANO plated reel seat
- Cloth bag + tip protector



AEX5TEGTM50	5.00m	141cm	5	186g	18g
AEX5TEGTLI60	6.00m	142cm	6	233g	10g
AEX5TEGTM60	6.00m	142cm	6	247g	18g
AEX5TEGTH60	6.00m	143cm	6	259g	25g
AEX5TEGTXH60	6.00m	143cm	6	322g	35g
AEX5TEGTM70	7.00m	144cm	7	311g	18g
AEX5TEGTH70	7.00m	144cm	7	320g	25g



GTH60

AERO BOLO X5 GT H 600

SHIMANO

5.9m 60

SHIMANO

# EXCELLENT FLOAT CONTROL



NEW

## AERO X3 BOLO GT

- Full carbon HPC, fast-action blank
- Lightweight Seaguide HLG guides
- SHIMANO plate reel seat
- Cloth bag + tip protector



AEX3TEGTM60	6.00m	144cm	6	334g	18g
AEX3TEGTH60	6.00m	144cm	6	343g	25g
AEX3TEGTXH60	6.00m	144cm	6	350g	35g
AEX3TEGTM70	7.00m	144cm	7	405g	18g
AEX3TEGTH70	7.00m	144cm	7	425g	25g





GT550

## ALIVIO DX TE GT 5

- Full Carbon + Geofibre blank with a progressive/fast action
- SHIMANO Hardlite guides
- SHIMANO custom plate reel seat
- Reinforced handle section for more strength and improved balance
- Supplied with a plastic guide protector for safe transport

ALDXTEGT540	3.90m	135cm	4	221g	4-20g
ALDXTEGT550	4.90m	138cm	5	305g	4-20g
ALDXTEGT560	6.00m	138cm	6	374g	4-20g

GEOFIBRE



650GT

## CATANA STATIC BAIT

- High Modulus Full Carbon blank with powerful lifting action for using large leads with bait fish
- Designed for freshwater predators but can also be used in saltwater when fishing from rocks or marina walls
- Seaguide stainless steel guides lined with titanium oxide for strength
- SHIMANO plate reel seat

CATSBTE650GT	6.50m	136cm	7	526g	Max. 150g
CATSBTE750GT	7.50m	137cm	8	662g	Max. 150g



# SLIM TELESCOPIC RODS



42XH

## VENGEANCE SLIM TE GT

- Full Carbon + Geofibre provides a strong versatile blank offering excellent value
- SHIMANO Stainless Steel Hardlite guides
- SHIMANO designed reel seat

GEOFIBRE

VARTE42H  
VARTE42XH

VARTE42H	4.20m	114cm	5	341g	20-60g
VARTE42XH	4.20m	114cm	5	367g	40-100g



27M

## ALIVIO SLIM TE GT

- Composite carbon blank offers excellent combination of quality and price
- SHIMANO Stainless Steel Hardlite guides
- SHIMANO designed reel seat
- EVA handle

ALVSLTEGT27M  
ALVSLTEGT27H  
ALVSLTEGT30H  
ALVSLTEGT33H  
ALVSLTEGT36H  
ALVSLTEGT27XH  
ALVSLTEGT30XH  
ALVSLTEGT33XH  
ALVSLTEGT36XH

ALVSLTEGT27M	2.70m	96cm	5	210g	10-30g
ALVSLTEGT27H	2.70m	96cm	5	230g	30-60g
ALVSLTEGT30H	3.00m	96cm	5	250g	30-60g
ALVSLTEGT33H	3.30m	98cm	6	310g	30-60g
ALVSLTEGT36H	3.60m	98cm	6	330g	30-60g
ALVSLTEGT27XH	2.70m	96cm	5	250g	40-80g
ALVSLTEGT30XH	3.00m	96cm	5	270g	40-80g
ALVSLTEGT33XH	3.30m	98cm	6	330g	40-80g
ALVSLTEGT36XH	3.60m	98cm	6	350g	40-80g



334080

## VENGEANCE AX SLIM TE

- Full Carbon blank
- SHIMANO Stainless Steel Hardlite guides
- DPS reel seat
- Cork handle

VAXSLTE271040  
VAXSLTE274080  
VAXSLTE304080  
VAXSLTE334080  
VAXSLTE364080

VAXSLTE271040	2.70m	94cm	5	181g	10-40g
VAXSLTE274080	2.70m	94cm	5	188g	40-80g
VAXSLTE304080	3.00m	94cm	5	197g	40-80g
VAXSLTE334080	3.30m	94cm	6	268g	40-80g
VAXSLTE364080	3.60m	101cm	6	282g	40-80g



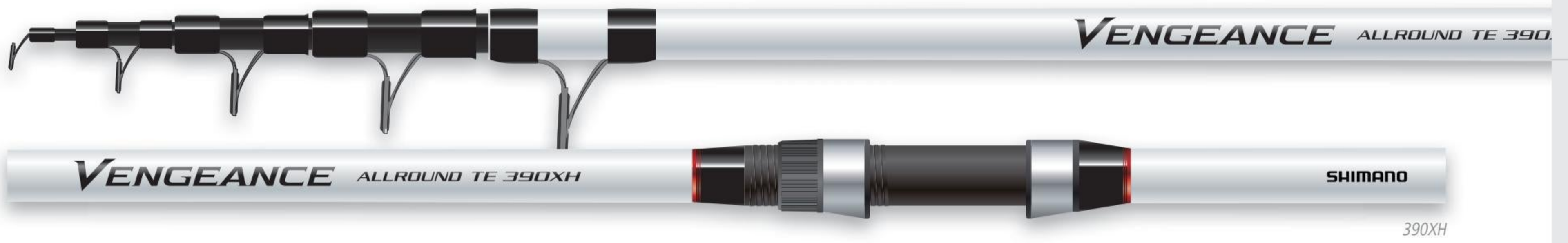

## VENGEANCE ALLROUND

- Strong Full Carbon all-round rod for multiple use
- SHIMANO Hardlite guides
- SHIMANO reel seat
- Cloth bag with a plastic guide protector

VARTE360H	3.60m	108cm	5	311g	50-100g
VARTE360XH	3.60m	108cm	5	326g	75-150g
VARTE390H	3.90m	118cm	5	324g	50-100g
VARTE390XH	3.90m	118cm	5	328g	75-150g



## ALIVIO ALLROUND

- Strong Full Carbon all-round rod for multiple use
- SHIMANO Hardlite guides
- SHIMANO reel seat
- Poly Bag and a guide protector

ALVARTE300H	3.00m	97cm	4	297g	50-100g
ALVARTE350H	3.50m	97cm	5	426g	50-100g



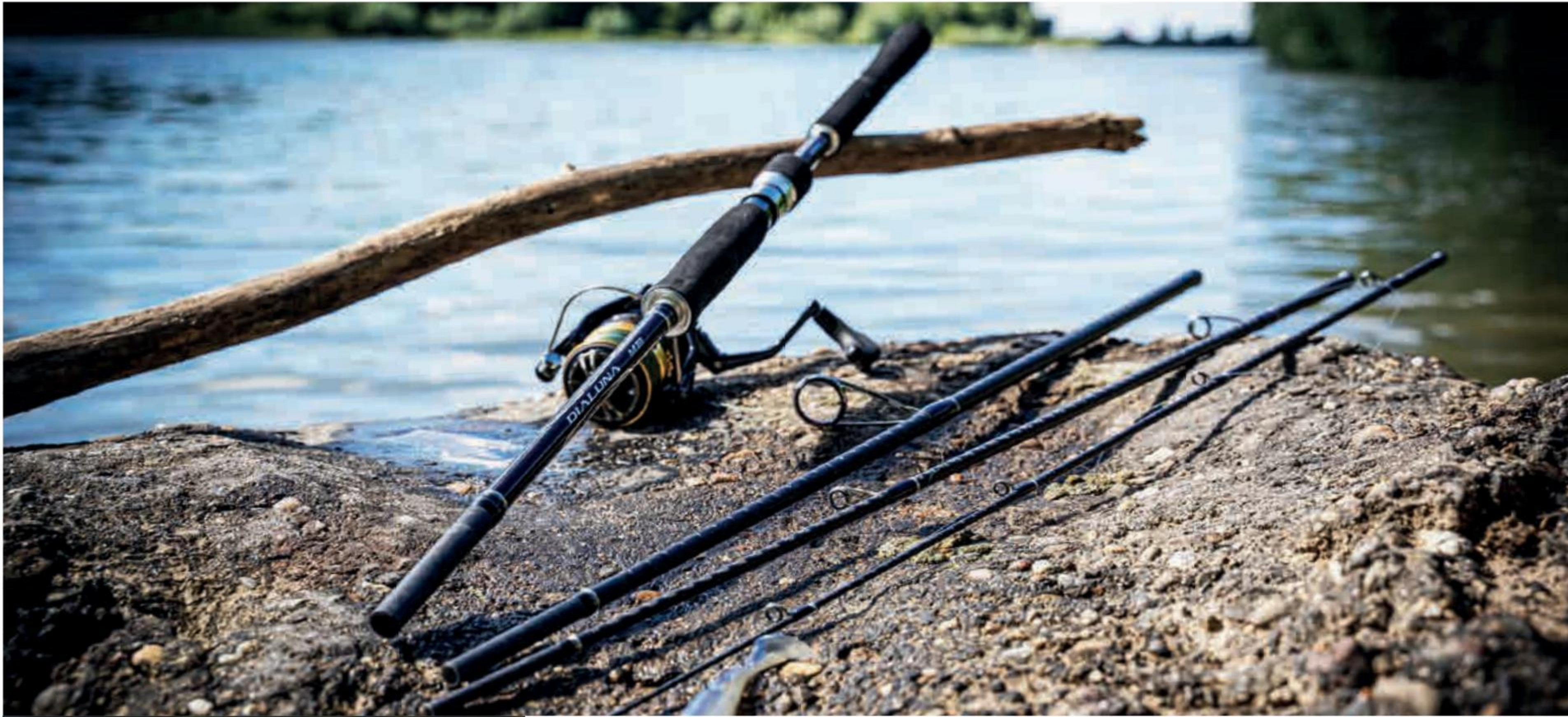

# SALTWATER PREDATOR RODS

SHIMANO saltwater predator rods cover all of the modern spinning styles found across Europe and the tropics from lightweight shad and jig fishing to heavyweight tuna and GT methods where strength is of the utmost importance. This year sees the introduction of several new models, specifically designed for the very latest techniques, that are now being used worldwide.



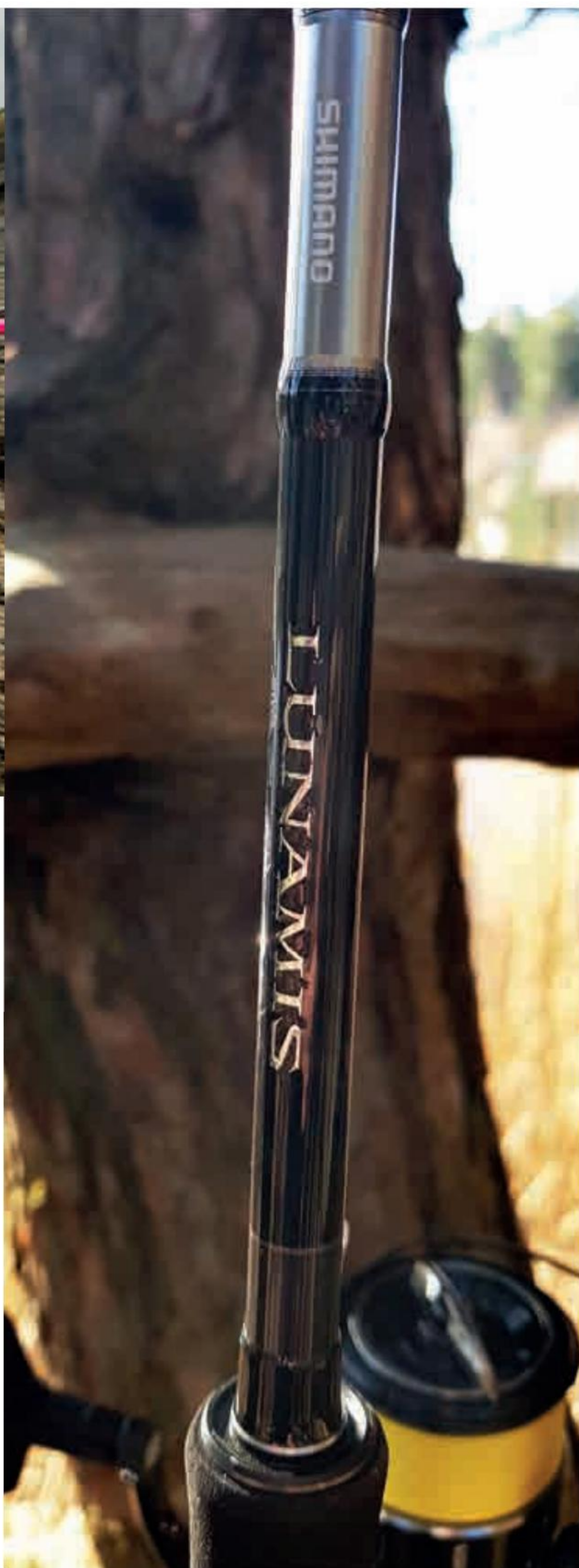

**SEA BASS**

204	LUNAMIS	<b>NEW MODEL</b>
205	DIALUNA	<b>NEW MODEL</b>
206	MOONSHOT	<b>NEW</b>
208	BASTERRA SEA BASS VENGEANCE CX	

**LIGHT ROCK FISHING**

209	BASTERRA
-----	----------

**EGING / SQUID**

210	SEPHIA BB TECHNIUM EGING VENGEANCE EGING
-----	--

**SEA TROUT**

211	ASPIRE SEA TROUT TECHNIUM SEA TROUT
-----	--

**FLOAT**

211	SONARA SW MATCH
-----	-----------------

**SALTWATER OFFSHORE CASTING**

212	OCEA PLUGGER FLEX GRAPPLER TYPE C	
213	GRAPPLER TYPE C 3-PIECE GRAPPLER BB TYPE C	<b>NEW</b>

**SALTWATER OFFSHORE JIGGING**

214	GAME TYPE LJ GAME TYPE J / SLOW J	
215	GRAPPLER TYPE J 3-PIECE GRAPPLER TYPE J / LJ / SLOW J	
216	GRAPPLER BB TYPE J / LJ / SLOW J	
218	VENGEANCE JIG BOAT SPEEDMASTER R JIGGING	<b>NEW</b>
219	ENGETSU BB	

**TAI RUBBER JIGGING**

219	TECHNIUM TAI RUBBER
-----	---------------------



# THE ULTIMATE ROD

NEW CASTING MODEL

## LUNAMIS

- The ultimate in rod carbon technology from the JDM collection featuring Spiral X Core + Hi-Power X + Nanopitch + Muscle Carbon
- Moderate/Fast action designed for long range lure casting for sea bass and other saltwater predators
- SHIMANO X guides with Fuji Titanium SiC
- SHIMANO Ci4+ Perfection reel seat for secure reel fixing
- Unique Carbon Monocoque handle for weight reduction and sensitivity



<b>SPINNING</b>					
20LUNAMISS86ML	2.59m	133cm	2	118g	6-25g
20LUNAMISS86M	2.59m	133cm	2	124g	7-35g
20LUNAMISS90L	2.74m	141cm	2	116g	5-21g
20LUNAMISS90ML	2.74m	141cm	2	122g	6-25g
20LUNAMISS96M	2.90m	149cm	2	136g	7-35g
20LUNAMISS96MH	2.90m	149cm	2	150g	10-45g
<b>CASTING</b>					
20LUNAMISB86M	2.59m	133cm	2	133g	10-40g <b>NEW</b>

20LUNAMISS96M

20LUNAMISB86M



18DLNS100MH



18DLNB86M



# PRECISE CASTING

## NEW CASTING MODEL

# DIALUNA





- Spiral X and Hi-Power X construction with moderate-fast action for extreme distance and precision casting
- Fuji SiC K guides
- Ci4+ reel seat with EVA handle
- Plastic case for comfortable transport



S86LS Only

Excludes S900MLMB



					
<b>SPINNING</b>					
DLNXS900MLMB	2.74m	73cm	4	152g	6-28g
18DLNS86LS	2.59m	133cm	2	108g	3-21g
18DLNS90ML	2.74m	141cm	2	128g	6-32g
18DLNS96M	2.90m	149cm	2	141g	8-45g
18DLNS100MH	3.05m	156cm	2	170g	10-56g
<b>CASTING</b>					
18DLNB86M	2.59m	134cm	2	133g	10-45g <b>NEW</b>



# RAPID TIP RECOVERY



NEW

## MOON SHOT

- Strong, lightweight Hi-Power X blank construction designed and developed in Japan
- Designed for Sea Bass fishing at long range using hard lures and jigs from the shore or rocks
- Fuji K-Type Alconite guides with Fuji SiC top guide
- Ergonomic SHIMANO custom reel seat
- EVA split grip handle for assured handling

					
21MSHOTS86ML	2.59m	134cm	2	133g	Plug 6-32g / Jig Max 38g
21MSHOTS90ML	2.74m	141cm	2	136g	Plug 6-32g / Jig Max 38g
21MSHOTS96M	2.90m	149cm	2	156g	Plug 8-42g / Jig Max 50g
21MSHOTS96MH	2.90m	149cm	2	180g	Plug 10-52g / Jig Max 60g





S86ML



S90ML



S96M

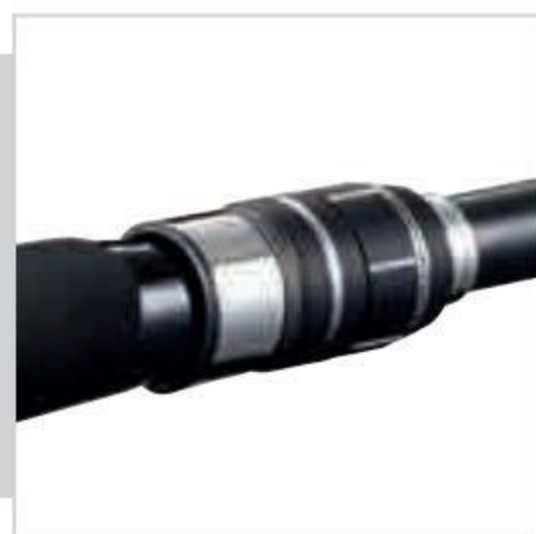

# SEA BASS RODS



## BASSTERRA SEA BASS

- Full Carbon blank + Diaflash for powerful, responsive casting performance and total fish-playing control
- Medium fast action for enhanced long range casting performance from either shore or boat
- Corrosion resistant tangle-free Seaguide XOG Stainless Steel guides
- Custom designed VSS reel seat with EVA handle
- Ideal for both softbait and hardbait fishing

BSTRSB80M	2.44m	125cm	2	134g	6-28g
BSTRSB90M	2.74m	139cm	2	145g	7-30g
BSTRSB90MH	2.74m	139cm	2	160g	12-38g
BSTRSB96H	2.89m	149cm	2	220g	15-60g



24SBMH

## VENGEANCE CX SEA BASS

- Entry level Sea Bass rod offering a wide range of models to suit different lure sizes and preferences from long range shore fishing to shorter range boat fishing
- Full Carbon blank
- Medium fast action for enhanced casting performance
- Corrosion resistant Stainless Steel guides with lined centres suitable for braid main lines
- Custom designed VSS reel seat with EVA handle

SVCX21SBM	2.10m	114cm	2	141g	7-35g
SVCX21SBMH	2.10m	114cm	2	149g	10-50g
SVCX21SBH	2.10m	114cm	2	155g	15-60g
SVCX24SBM	2.40m	130cm	2	167g	7-35g
SVCX24SBMH	2.40m	130cm	2	172g	10-50g
SVCX24SBH	2.40m	130cm	2	185g	15-60g
SVCX27SBMH	2.70m	145cm	2	140g	10-50g
SVCX27SBH	2.70m	145cm	2	149g	15-60g







# LIGHT ROCK FISHING

## BASSTERRA LRF

- Full Carbon blank + Diaflash for responsive performance and total fish-playing control in tight situations around underwater snags and rocks
- Fast action with a solid tip for maximum feel and bite registration
- Corrosion resistant tangle-free Seaguide XOG Stainless Steel guides
- Custom designed VSS reel seat with EVA handle
- Available in light power (1-11g casting weight) for super sensitive situations and light-plus power (3-15g casting weight) for more demanding situations where slightly bigger lures are preferred



BSTR LRF72L	2.18m	113cm	2	95g	1-11g
BSTR LRF80LP	2.44m	125cm	2	115g	3-15g



# EGING, SEA TROUT & FLOAT RODS



583ML

## Sephia BB

- Strong but very light Hi-Power X blank with the correct moderately fast, forgiving action for squid fishing
- Anti tangle Fuji Alconite K-type guides for maximum casting performance
- SHIMANO custom designed reel seat with EVA grip
- Red and black colour graphics match perfectly with the Sephia BB reel



18SEPHIABBS83ML



2.51m



129cm



2



100g



EGI 1.8-3.8g



83M

## TECHNIUM EGING

- Very responsive High Modulus Full Carbon blank in a striking blue colour with black details
- The perfect blank action for long range casting with EGI lures
- Lightweight Fuji Stainless Steel FazLite KR type guides for faultless performance
- SHIMANO VSS reel seat with ergonomic EVA handle
- Unique 'squid ink' design graphics

TECEGI83M



2.51m



130cm



2



122g



EGI 2.5-4.0g



83M

## VENGEANCE EGING

- Responsive EGI (Squid) rod offering great value for money
- Full Carbon blank
- 2.5m length delivers versatile performance from all fishing positions with long range casting characteristics
- Suitable for EGI lures sizes 2.0 - 3.5
- Corrosion resistant Stainless Steel guides with lined centres suitable for braid main lines
- Custom designed VSS reel seat with EVA handle

VENGEGI83M



2.50m



132cm



2



116g



EGI 2.0-3.5g



90M

## ASPIRE SEA TROUT

- Ultra slim blank built using SHIMANO'S leading carbon technology - Spiral X Core, Hi-Power X and Nanopitch
- Moderately fast responsive action for long distance casting using light lures, spoons and rubber shads
- Power reserves in lower part of the rod for excellent fish-fighting control, especially in shallow water
- Fuji Stainless Steel SiC K-Type guides improves casting performance
- Custom designed SHIMANO Ci4+ reel seat with high quality cork handle



ASPSTTG90ML	2.74m	141cm	2	140g	5-25g		
ASPSTTG90M	2.74m	141cm	2	147g	7-35g		
ASPSTTG96MH	2.89m	149cm	2	157g	10-40g		
ASPSTTG100M	3.05m	156cm	2	158g	7-35g		
ASPSTTG100MH	3.05m	156cm	2	166g	10-40g		



## TECHNIUM SEA TROUT

- High Modulus Full Carbon + Nanosheet carbon produces lightweight and responsive blank
- Moderately fast action is optimised for long distance casting with light lures
- Fuji Stainless Steel FazLite K-Type guides improve casting performance
- Custom designed SHIMANO reel seat with high quality cork handle and rear grip
- Perfect action for casting small hardbaits and spoons



TECHST101	3.08m	158cm	2	178g	15-45g	
TECHST111	3.37m	172cm	2	200g	15-45g	



420FA

## Sonora™ SW MATCH

- Saltwater match rods designed for float fishing
- Strong Composite blank with progressive action
- Lightweight SHIMANO Hardlite guides
- Full EVA handle with DPS reel seat
- Available in 3 piece and telescopic models in both fast action and stronger specimen actions
- Designed for float fishing in harbours, docks and from rocks for small saltwater fish

SONSWM420FA	4.20m	148cm	3	260g	20g	
SONSWM450SP	4.50m	158cm	3	290g	30g	
SONSWMTE420FA	4.20m	115cm	8	306g	20g	
SONSWMTE450SP	4.50m	122cm	9	315g	30g	

# SALTWATER OFFSHORE CASTING RODS



83H

## OCEA PLUGGER FLEX LIMITED

- Spiral X and Hi-Power X carbon construction with excellent power
- Medium fast tip action for hard fighting fish
- Fuji SiC K-type guides
- Fuji DPS reel seat
- EVA handle
- Soft case bag

					
OPFLSLTD83MH	2.52m	185cm	2 (SH)*	350g	110g
OPFLSLTD83H	2.52m	185cm	2 (SH)*	355g	130g



580M

## GRAPPLER Type C

- Super strong Spiral X + Hi-Power X blanks are capable of fighting big offshore fish like tuna and kingfish
- Fuji Alconite K-type + SiC(tip) guides for lightness, strength and saltwater resistance
- Fuji DPS / T-DPS / SHIMANO Ci4+ Perfection / Ci4+ Multi Palming Touch handles depending on model
- Four models available designed for a unique style of fishing - jigging, light jigging, slow jigging and casting

					
19GRTCS73ML	2.21m	170cm	2(SH)*	209g	80g
19GRTCS80M	2.44m	183cm	2(SH)*	256g	100g
19GRTCS77MH	2.31m	170cm	2(SH)*	274g	120g
19GRTCS82H	2.49m	182cm	2(SH)*	326g	150g





S82H3

## GRAPPLER *Type C*

### 3-PIECE

- Japanese designed ultra slim Spiral X Core + Hi-Power X full carbon blanks
- Fuji reel seat + lock nut for secure fixation
- Fuji Stainless Steel Alconite MN guides
- Ergonomic shaped EVA front grip
- 3 piece construction for easy transport

21GRPC3PS82MH3	2.49m	89cm	3	332g	Max 120g
21GRPC3PS82H3	2.49m	89cm	3	350g	Max 150g



NEW

## GRAPPLER BB *Type C*

- Japanese designed Hi-Power X full carbon blanks
- Fuji DPS reel seat
- Fuji Stainless Steel K-type guides
- Ergonomic shaped EVA grips
- 1+1 piece blanks (separate handle)
- Fuji rubber gimbal for improved fish-playing comfort (excludes S80M)

21GRAPBBCS80M	2.44m	183cm	2 (SH)*	254g	Max 100g
21GRAPBBCS82MH	2.49m	182cm	2 (SH)*	324g	Max 120g
21GRAPBBCS82H	2.49m	182cm	2 (SH)*	350g	Max 150g



# SALTWATER OFFSHORE JIGGING RODS



B632

## GAME Type LJ

- Japanese designed ultra slim Spiral X Core + Hi-Power X high modulus carbon blanks
- 1+1 construction, with separate handle for easy transport
- Casting models have SHIMANO Ci4+ Multi-palming touch reel seat
- Spinning models have SHIMANO Ci4+ Perfection seat reel seat
- Fuji Stainless Steel SiC + SHIMANO X-Guide 3D Titanium guides
- Split grip EVA grips

					
21GAMELJB632	1.91m	191cm	2(SH)*	110g	50-160g
21GAMELJS632	1.91m	191cm	2(SH)*	122g	40-160g



S624

## GAME Type J / Type Slow J

- Spiral X Core and Hi-Power X construction for increased strength and reduction to twisting whist jigging and fish-playing
- Jigging models have moderate-fast action and Slow models have moderate-slow actions to enhance lure action
- Fuji Stainless SiC guides
- Ci4+ custom designed reel seat
- EVA split grip handle
- High quality cloth bag

					
20GAMETYPJS5105	1.78m	128cm	2(SH)*	187g	250g
20GAMETYPJS624	1.88m	139cm	2(SH)*	162g	210g
20GAMETYPJB605	1.83m	140cm	2(SH)*	175g	250g
<b>SLOW</b>					
20GAMETSJB661	1.98m	151cm	2(SH)*	123g	160g
20GAMETSJB662	1.98m	151cm	2(SH)*	128g	200g
20GAMETSJB663	1.98m	151cm	2(SH)*	132g	260g
20GAMETSJB664	1.98m	151cm	2(SH)*	139g	330g





S6043

## GRAPPLER *Type J*

### 3-PIECE

- Japanese designed ultra slim Spiral X + Hi-Power X high modulus carbon blanks
- Fuji reel seat + lock nut for secure fixation
- Fuji Stainless Steel K-type guides
- Ergonomic shaped EVA front grip
- 3 piece construction for easy transport

21GRPJ3PS6043



1.83m



69cm



3



182g



Max 210g



S604

## GRAPPLER *Type J / Type LJ / Type Slow J*

- The Spiral X + Hi-Power X carbon blanks are super strong and capable of fighting big offshore fish like tuna and kingfish
- Spinning, jigging, light jigging, slow jigging and casting models available
- Fuji Alconite K-type guides + SiC tip
- Fuji DPS / T-DPS / SHIMANO Ci4+ Perfection / Ci4+ Multi Palming Touch reel seats depending on model selection
- EVA handle
- 1+1 handle design produces seamless fighting action and shorter transport length

#### SPINNING

19GRTJS603



1.83m



131cm



2(SH)\*



165g



180g

19GRTJS604

1.83m

130cm

2(SH)\*

172g

210g

19GRTJS605

1.83m

130cm

2(SH)\*

180g

250g

19GRTLJ632

1.91m

146cm

2(SH)\*

125g

40-160g

#### BAITCASTING

19GRTSJB682

2.03m

156cm

2(SH)\*

115g

200g

19GRTSJB683

2.03m

156cm

2(SH)\*

120g

260g

19GRTSJB684

2.03m

156cm

2(SH)\*

125g

330g

19GRTLJ632

1.91m

144cm

2(SH)\*

112g

50-160g

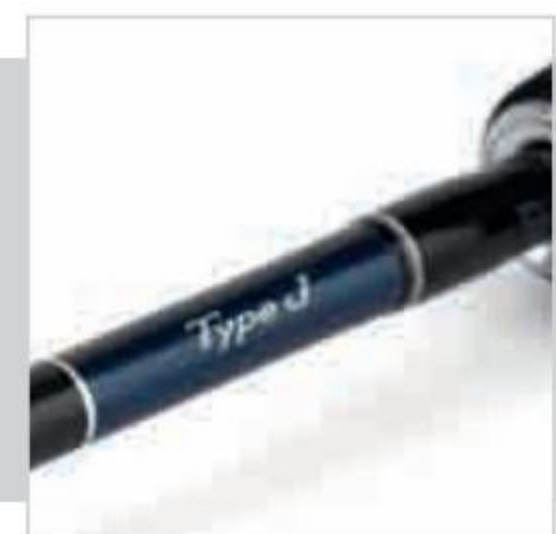



# PERFECTLY TUNED FOR THEIR INTENDED USE

## **GRAPPLER BB** *Type J / Type LJ / Type Slow J*

- Hi-Power X blanks
- SHIMANO custom reel seat (Type LJ), Fuji reel seat (Type J & Type Slow J)
- Fuji Stainless Steel K-type guides
- Ergonomic shaped EVA grips
- 1+1 piece blanks (offset handle)
- Available in Jigging, Light Jigging and Slow Jigging model variations

21GRPBBJS603	1.83m	133cm	2 (SH)*	172g	Max 180g
21GRPBBJS604	1.83m	133cm	2 (SH)*	185g	Max 210g
21GRPBBJS605	1.83m	130cm	2 (SH)*	193g	Max 250g
21GRPBBJSB662	1.98m	151cm	2 (SH)*	120g	Max 200g
21GRPBBJSB663	1.98m	151cm	2 (SH)*	125g	Max 260g
21GRPBBJSB664	1.98m	151cm	2 (SH)*	135g	Max 330g
21GRPBLLJB631	1.91m	146cm	2 (SH)*	112g	40-130g
21GRPBLLJB632	1.91m	146cm	2 (SH)*	117g	50-160g
21GRPBLLJS631	1.91m	148cm	2 (SH)*	122g	30-130g
21GRPBLLJS632	1.91m	148cm	2 (SH)*	127g	40-160g







Type J - JS604



Type LJ - LJS631



Type Slow J - SJB633



# SALTWATER OFFSHORE JIGGING / TAI RUBBER



183MHS

## VENGEANCE JIGGING BOAT

- Full Carbon blank construction for assured strength
- Designed specifically for vertical jigging
- SHIMANO Hardlite stainless steel guides suitable for braid and mono
- DPS reel seat
- EVA handle for comfort and secure handling

VJBT183MHS

				
1.83m	118cm	2 (SH)*	320g	100-300g



B603

S603

NEW

## SPEEDMASTER R JIGGING

- High Modulus Full Carbon blank with silver/black styling
- Seamless 2-piece construction with detachable handle
- Robust low profile Fuji MN 'O-Concept' guides on multiplier/baitcasting reel models
- Lightweight single leg Fuji Y 'O-Concept' guides on spinning reel models
- Ergonomic EVA handle with SHIMANO reel seat
- Available in Spinning and Multiplier/Baitcasting configurations

CASTING

19SPMRB584	1.74m	122cm	2(SH)*	180g	210g
19SPMRB603	1.83m	132cm	2(SH)*	174g	180g
19SPMRB631	1.91m	132cm	2(SH)*	130g	120g
19SPMRB632	1.91m	132cm	2(SH)*	139g	150g

SPINNING

19SPMRS565	1.68m	117cm	2(SH)*	183g	250g
19SPMRS584	1.74m	123cm	2(SH)*	176g	210g
19SPMRS603	1.83m	132cm	2(SH)*	174g	180g
19SPMRS631	1.91m	132cm	2(SH)*	141g	120g
19SPMRS632	1.91m	132cm	2(SH)*	149g	150g

				
---	---	---	---	---





69MS

## ENGETSU BB

- Selected from the Japanese product range for light Tai Rubber jigging
- Solid Taftec Alpha tip produces the perfect action to work lures correctly and spot sensitive bites
- Fuji SiC K-type guides
- SHIMANO custom design casting reel seat

ENGTBBB69MS

				
2.06m	158cm	2	105g	40-130g





72M

## TECHNIUM TAI RUBBER

- Lightweight Full Carbon blank with progressive action for light jig and tai rubber lure presentation
- Solid tip for extra sensitive bite detection
- Seaguide Hero guides
- Ergonomic SHIMANO custom reel seat
- Split EVA handle

TECTR72M  
TECTR72H

				
2.18m	113cm	2	116g	130g
2.18m	113cm	2	126g	220g



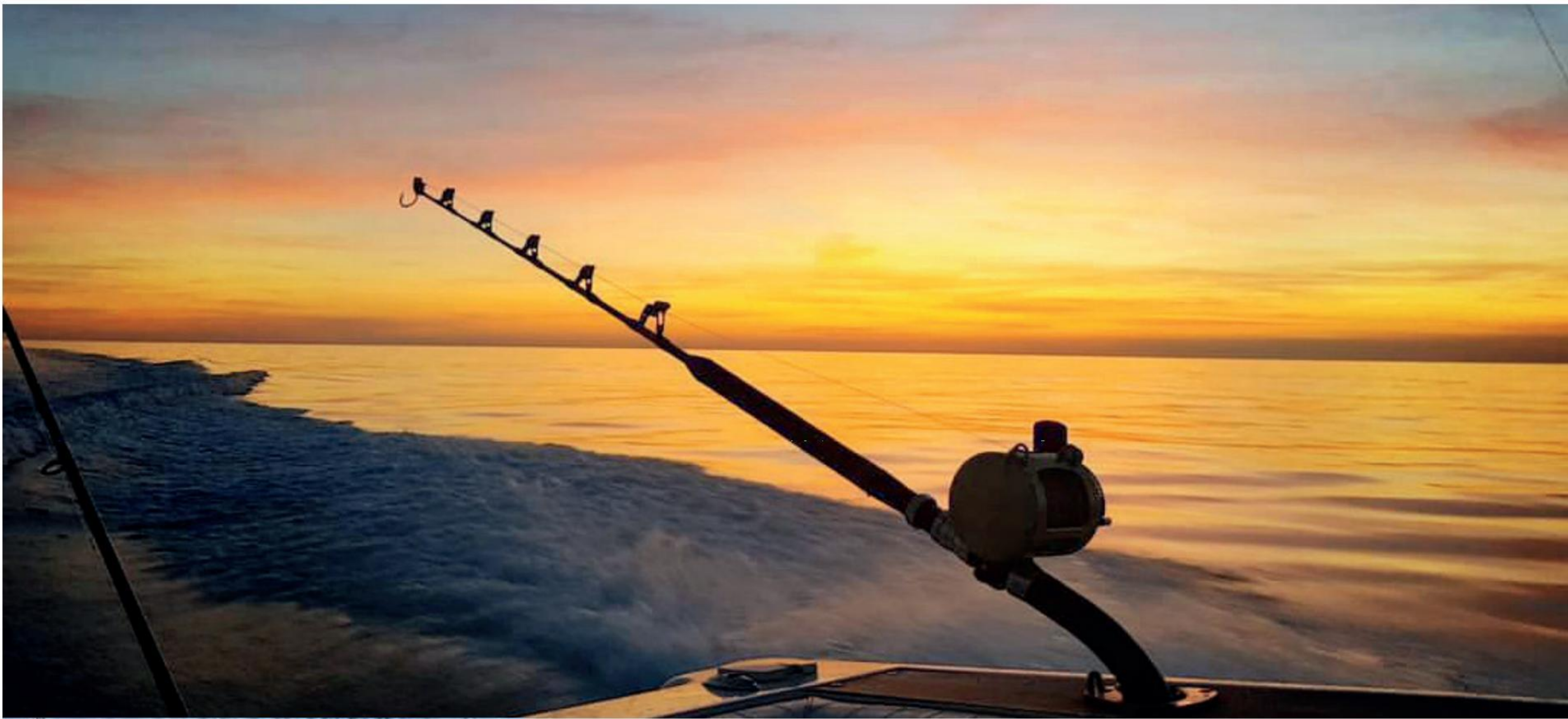

## BOAT RODS

From powerful trolling rods designed for tuna and marlin to deep bottom fishing rods used with electric reels, SHIMANO Boat Rod range covers everything needed for the salt water angler.





**STAND-UP**

- |     |                       |  |
|-----|-----------------------|--|
| 222 | TIAGRA ULTRA GAME     |  |
|     | TIAGRA HYPER STAND-UP |  |
| 223 | TYRNOS STAND-UP       |  |
|     | TLD STAND-UP          |  |
|     | VENGEANCE STAND-UP    |  |

**STAND-UP SPIRAL**

- |     |                      |            |
|-----|----------------------|------------|
| 224 | BEASTMASTER STAND-UP | <b>NEW</b> |
|     | VENGEANCE STAND-UP   | <b>NEW</b> |

**TROLLING**

- |     |                         |            |
|-----|-------------------------|------------|
| 225 | TYRNOS TROLLING         |            |
|     | TYRNOS B TROLLING LITE  | <b>NEW</b> |
|     | CATANA DX TROLLING LITE | <b>NEW</b> |

**BOAT**

- |     |                          |            |
|-----|--------------------------|------------|
| 226 | SPEEDMASTER AX DEEP DROP | <b>NEW</b> |
| 227 | BEASTMASTER CX BOAT      |            |
|     | VENGEANCE AX BOAT        |            |
|     | ALIVIO BOAT              |            |

**SLIM / BRAID BOAT**

- |     |                          |            |
|-----|--------------------------|------------|
| 228 | ASPIRE BOAT SLIM         | <b>NEW</b> |
|     | BEASTMASTER BX BOAT SLIM |            |
|     | VENGEANCE AX BOAT SLIM   |            |

229 ALIVIO BX TELE BOAT

**BOAT QUIVER**

- |     |                            |  |
|-----|----------------------------|--|
| 230 | BEASTMASTER AX BOAT QUIVER |  |
|     | CATANA BOAT QUIVER         |  |
| 231 | ALIVIO BOAT QUIVER         |  |
|     | SONARO BOAT QUIVER         |  |

**PILK**

- |     |                  |  |
|-----|------------------|--|
| 232 | BEASTMASTER PILK |  |
|     | VENGEANCE PILK   |  |

**INNERGUIDE**

- |     |                           |  |
|-----|---------------------------|--|
| 233 | BEASTMASTER CX INNERGUIDE |  |
|-----|---------------------------|--|

**DOWNRIGGER**

- |     |                           |  |
|-----|---------------------------|--|
| 233 | BEASTMASTER BX DOWNRIGGER |  |
|-----|---------------------------|--|



# STAND-UP RODS



50STP

## TIAGRA ULTRA GAME

- SHIMANO'S flagship trolling rod built with the latest carbon technology - Spiral X + Hi-Power X
- Alps BRX Stainless Steel roller guides
- Winn grip front grip and woven carbon rear grip
- Pac Bay Black Aluminium reel holder
- Carbon butt in both straight and bent configurations
- High class Neoprene bag

TIULT50STP	1.65m	125cm	2 (SH)*	801g/908g	50lbs
TIULT80STP	1.65m	125cm	2 (SH)*	871g/977g	80lbs

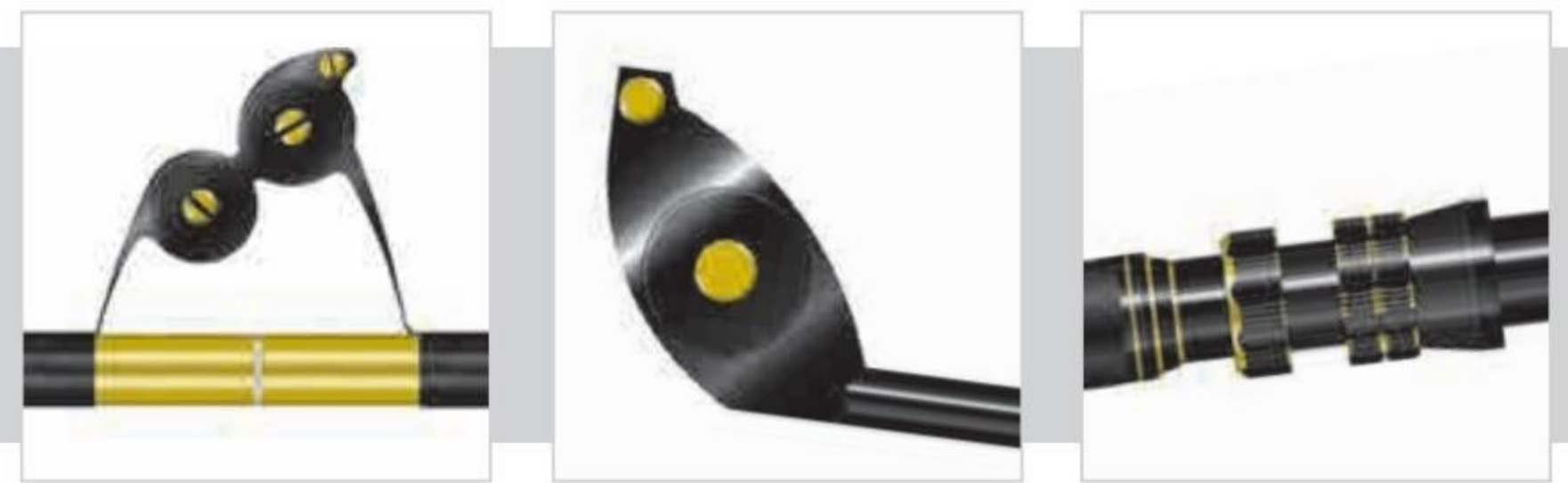

50SUBB

## TIAGRA HYPER STAND-UP

- Strong, powerful Full Carbon + HPC + Nanosheet blank, resulting in reduced diameter and higher torsional twist resistance
- Full carbon butt section 30lb - straight, 50lb/80lb - bent
- Black leather Winn Grip for maximum grip and comfort even in wet conditions
- Alloy gimbal to secure the rod to the fighting belt
- Pac Bay Channel Lock Black Aluminium reel holder
- Strong, lightweight Aftco roller guides AFTCO HD (30/50) / WO (80)

18TIH30SUBB	1.75m	133cm	2 (SH)*	792g	30lb
18TIH50SUBB	1.73m	131cm	2 (SH)*	878g	50lb
18TIH80SUBB	1.68m	119cm	2 (SH)*	1188g	80lb





## TYRNOS A STAND-UP

30R

- Full Carbon + HPC + Biofibre blank with Twist Control
- ALPS heavy duty guides with SiC lining for the 30lb model
- SHIMANO aluminium roller guides with stainless steel rollers for 50 and 80lb models
- Ergonomic shaped EVA front grip
- One piece construction
- Neoprene bag



TYRASTP30R	1.65m	165cm	1	660g	30lb
TYRASTP50R	1.65m	165cm	1	685g	50lb
TYRASTP80R	1.65m	165cm	1	716g	80lb



20

## TLD A STAND-UP

- Thin but strong blank made of Full Carbon+ Biofibre
- SHIMANO Stainless Steel Hardlite guides on 20 lb model and SHIMANO roller guides on the other models
- Aluminium butt reel seat
- Perfect choice to fish for big tuna with a reasonable priced, powerful and trustworthy stand-up rod



TLDASTP20	1.68m	168cm	1	495g	20lb
TLDASTP30R	1.68m	168cm	1	701g	30lb
TLDASTP50R	1.68m	168cm	1	734g	50lb
TLDASTP80R	1.68m	168cm	1	752g	80lb



2030

## VENGEANCE STAND-UP

- Composite carbon blank offers good value for money combined with reliable performance
- SHIMANO Stainless Steel Hardlite guides
- Aluminium butt reel seat
- EVA profiled grips for secure handling

VSTP816	1.65m	165cm	1	439g	8-16lb
VSTP1620	1.65m	165cm	1	494g	16-20lb
VSTP2030	1.65m	165cm	1	497g	20-30lb
VSTP3050	1.65m	165cm	1	511g	30-50lb

# STAND-UP SPIRAL / TROLLING RODS







805

NEW

## *BeastMaster* STAND-UP SPIRAL

- Ultra strong Composite blank
- Unique spiral guide placement reduces stress and improves playing action
- Ultra strong Seaguide XRG guides for mono or braided lines
- Aluminium reel seat for rock-solid reel placement
- Ergonomic EVA handle for assured grip under pressure

					
BMCXSTP50S	1.65m	165cm	1	-	50lbs
BMCXSTP80S	1.65m	165cm	1	-	80lbs



505

NEW

## *VENGEANCE* STAND-UP SPIRAL

- Powerful Composite blank in 50lb and 80lb line rating
- Unique spiral guide placement reduces stress and improves playing action
- Strong SHIMANO Hardlite guides for mono or braided lines
- Aluminium reel seat for rock-solid reel placement
- Ergonomic EVA handle for assured grip under pressure

					
VSTP50S	1.65m	165cm	1	-	50lbs
VSTP80S	1.65m	165cm	1	-	80lbs







50

## TYRNOS TROLLING

- Full Carbon + HPC + Biofibre blank delivers outstanding performance across the full range of models
- SHIMANO Stainless Steel roller guides on 50 & 80 models
- Aluminium butt reel seat
- EVA front grip for secure handling
- Aluminium rear grip



TYRTRL50	2.13m	172cm	2 (SH)*	1079g	50lb
TYRTRL80	2.13m	165cm	2 (SH)*	1285g	80lb
TYRTRL80B	2.13m	152cm	2 (SH)*	1429g	80lb
TYRTRL130	2.13m	165cm	2 (SH)*	1484g	130lb
TYRTRL130B	2.13m	152cm	2 (SH)*	1612g	130lb



L12

NEW

## TYRNOS B TROLLING LITE

- Full Carbon HPC + Biofibre + Twist Control blanks
- Fuji K-Type Alconite spiral mounted for improved line flow
- Ergonomic EVA grips
- 1+1 piece construction with separate handle
- Pac Bay Aluminium reel seat and gimbal



TYRBRTRLL6	2.08m	169cm	2 (SH)*	516g	6lb
TYRBRTRLL12	2.08m	169cm	2 (SH)*	525g	12lb
TYRBRTRLL16	2.03m	163cm	2 (SH)*	580g	16lb
TYRBRTRLL20W	2.03m	163cm	2 (SH)*	693g	20lb



L12

NEW

## CATANA DX TROLLING LITE

- Full Carbon blanks
- Seaguide Stainless Steel spiral mounted for improved line flow
- Ergonomic EVA grips
- 1+1 piece construction with separate handle
- Aluminium reel seat and gimbal

CATDXTRLL6	2.09m	164cm	2 (SH)*	521g	6lb
CATDXTRLL12	2.09m	164cm	2 (SH)*	547g	12lb
CATDXTRLL16	2.04m	159cm	2 (SH)*	570g	16lb
CATDXTRLL20	2.04m	158cm	2 (SH)*	588g	20lb

# FOR DEEP SEA

NEW

## *SpeedMaster* AX DEEP DROP

- Exceptionally strong high modulus carbon + HPC + Nanosheet + biofibre blank
- Designed exclusively for deep water fishing with electric reels
- Fuji spiral mounted MN guides for trouble free performance
- 1+1 pieces construction with offset handle
- EVA grips
- Aluminium reel seat and gimbal



SMAXDD692060	2.06m	140cm	2 (SH)*	653g	200-600g
SMAXDD6950100	2.06m	140cm	2 (SH)*	660g	500-1000g
SMAXDD6980150	2.06m	140cm	2 (SH)*	693g	800-1500g
SMAXDD7650100	2.29m	162cm	2 (SH)*	720g	500-1000g
SMAXDD7680150	2.29m	162cm	2 (SH)*	720g	800-1500g





3050

## Beast Master CX BOAT

- Full Carbon + HPC + Biofibre for strength and power
- SHIMANO Hardlite Guides
- DPS type reel seat
- EVA grips for comfort and durability



BMCXBT2030

2.28m	115cm	2	599g	20-30lb



240H

## Vengeance AX BOAT

- Composite blank for strength and more fish control
- SHIMANO Hardlite Guides
- DPS type reel seat
- EVA grips for comfort and durability in saltwater

VAXB240H  
VAXB270H  
VAXB270XXH

2.40m	125cm	2	428g	300g
2.70m	140cm	2	477g	300g
2.70m	140cm	2	530g	500g



## ALIVIO BOAT

- Composite blank combining great power with excellent sensitivity
- SHIMANO Hardlite Guides
- DPS type reel seat
- Rubber ended handle designed for grip and to prevent the rod from slipping when placed on the boat

ALVBT135150  
ALVBT150200

1.35m	86cm	1+1	179g	150g
1.50m	99cm	1+1	185g	200g

# SLIM / BRAID BOAT RODS



NEW

762030B

## ASPIRE BOAT SLIM

- High modulus Full Carbon blanks, with Spiral X blank construction producing slim, lightweight, strong blanks with enhanced torsional rigidity
- Hi-Power X reinforcement to minimize twist and increase strength when playing large fish
- Fuji Stainless Steel braid guides with SiC linings
- SHIMANO custom designed ergonomic aluminium reel seat with locking ring
- Aluminium gimbal with rubber cap for fighting big fish
- Ergonomic shaped EVA front grip for assured handling



ASBTAX761220B	2.29m	166cm	2 (SH)*	-	12-20lb
ASBTAX762030B	2.29m	166cm	2 (SH)*	-	20-30lb
ASBTAX763050B	2.29m	166cm	2 (SH)*	-	30-50lb



7620302

## BeastMaster BX BOAT SLIM

- Slim, ultra strong, Full Carbon blank designed for large fish
- Classic Beastmaster black and gold colour combination
- Special Braid-type guides
- SHIMANO Aluminium extra strong reel seat with double locking rings
- EVA Split Grip with rubber gimbal

BMBXBTSL7612202	2.29m	164cm	2 (SH)*	421g	12-20lb
BMBXBTSL7620302	2.29m	164cm	2 (SH)*	429g	20-30lb
BMBXBTSL7630502	2.29m	164cm	2 (SH)*	467g	30-50lb



762030

## VENGEANCE AX BOAT SLIM

- Full Carbon blank has a responsive, moderate action and is an ideal all-round boat rod offering excellent value
- SHIMANO Stainless Steel double leg guides for strength
- Full EVA handle with SHIMANO DPS reel seat
- Rubber cap end for comfortable fish-playing

VAXBTSLS761220	2.29m	164cm	2 (SH)*	259g	12-20lb
VAXBTSLS762030	2.29m	164cm	2 (SH)*	263g	20-30lb
VAXBTSLS763050	2.29m	164cm	2 (SH)*	265g	30-50lb







24H

# COMPACT LENGTHS

## ALIVIO BX TELE BOAT

- Composite blank
- Short transport length telescopic boat rod with powerful action
- SHIMANO Hardlite guides with corrosion resistant Stainless Steel frames and lined centres suitable for braid and mono lines
- Available in five lengths from compact 1.8m to longer 3.0m lengths for larger boats
- Custom designed SHIMANO reel seat and rubber fighting butt

					
ALVBXBTTE18H	1.80m	92cm	3	131g	50-150g
ALVBXBTTE21H	2.10m	110cm	3	146g	50-150g
ALVBXBTTE24H	2.40m	115cm	4	218g	50-150g
ALVBXBTTE27H	2.70m	115cm	4	250g	50-150g
ALVBXBTTE30H	3.00m	115cm	4	281g	50-150g



# BOAT QUIVER RODS



270XH

## *Beast Master* AX BOAT QUIVER

- Lightweight High Modulus Full Carbon blank with fast action and excellent strength
- SHIMANO DPS reel seat
- Seaguide Hero stainless steel anti-tangle guides
- Supplied with two interchangeable quiver tips
- Rated for fishing with weights of up to 300g
- Removable rubber bulb on base of handle

BMAXBT2Q240XH	2.40m	127cm	2+ tips	222g	max. 300g
BMAXBT2Q270XH	2.70m	142cm	2+ tips	254g	max. 300g
BMAXBT2Q300XH	3.00m	156cm	2+ tips	305g	max. 300g



30

## **CATANA** BOAT QUIVER

- Full Carbon blank
- SHIMANO Stainless Steel Hardlite guides
- DPS reel seat
- Two interchangeable tips for versatile bite detection

CATBT3Q30	3.00m	104cm	3	239g	30-150g





180

## ALIVIO BOAT QUIVER

- Powerful, strong Composite blank with solid white coloured tip for extra bite detection sensitivity
- Designed for various Mediterranean legering and bolentino style of techniques
- SHIMANO Hardlite guides
- SHIMANO DPS reel seat
- Easy clean EVA handle



					
ALVBTQ150	1.50m	81cm	2	154g	50-150g
ALVBTQ180	1.80m	96cm	2	174g	50-150g
ALVBTQ210	2.10m	111cm	2	192g	50-150g



180

## SONORA™ BOAT QUIVER

- Strong Composite Carbon + Glass blank with solid orange coloured tip for extra bite detection sensitivity
- Designed for various Mediterranean legering and bolentino style of techniques
- SHIMANO Hardlite guides
- SHIMANO DPS reel seat
- Easy clean EVA handle

					
SONBTQ150	1.50m	81cm	2	140g	50-150g
SONBTQ180	1.80m	96cm	2	166g	50-150g
SONBTQ210	2.10m	111cm	2	186g	50-150g



# BOAT PILK / INNERGUIDE / DOWN RIGGER RODS



240150300

## Beast Master PILK

- High Modulus Full Carbon blank is light, slim and very strong with a moderate fast action designed for pilk lures
- Seaguide Stainless Steel MN guides have immense strength
- SHIMANO DPS reel seat and split EVA handle
- Pacific Bay butt cap for comfortable fish-playing
- Perfect for pilk and softbait fishing for cod, coalfish and small halibut

					
BMPILK240100200	2.40m	123cm	2	255g	100-200g
BMPILK240150300	2.40m	123cm	2	257g	150-300g
BMPILK27070140	2.70m	138cm	2	267g	70-140g
BMPILK2154095	2.15m	108cm	2	207g	40-95g
BMPILK2404095	2.40m	123cm	2	224g	40-95g
BMPILK2704095	2.70m	138cm	2	241g	40-95g



240100200

## VENGEANCE PILK

- Responsive, lightweight Full Carbon blanks, powerful enough to fight the big Northern Europe saltwater species
- Entry-level rod especially designed for pilk and softbait methods
- Strong, corrosion resistant SHIMANO stainless steel guides
- SHIMANO DPS reel seat for solid reel fixation

					
SVPIK21070140	2.10m	112cm	2	204g	70-140g
SVPIK240100200	2.40m	126cm	2	226g	100-200g
SVPIK27070140	2.70m	141cm	2	265g	70-140g







220XH

## Beast Master CX INNERGUIDE

- Super strong and powerful High Modulus Full Carbon blank
- Innerguide system has three main advantages. Lightweight and well balanced. Easy to hold straight, rod doesn't want to turn. No chance of knots catching in guides
- Fuji DPS reel seat (MH/H) / Fuji DPS-H reel seat (XH)
- EVA handle

BMCXIG220XH	2.20m	79cm	3	302g	200-450g
BMCXIG220H	2.20m	79cm	3	220g	100-250g
BMCXIG240MH	2.40m	181cm	2	213g	100g



90H

## Beast Master BX DOWN RIGGER

- Full Carbon blank + Biofibre creates a strong downrigger
- SHIMANO Stainless Steel Hardlite guides
- SHIMANO designed reel seat
- EVA grips with long front grip for secure handling
- S.D.R. prevents twisting of the blank

BMBXDR86M	2.74m	136cm	2	294g	15-30lb



BIOFIBRE



## SURF RODS

SHIMANO surf rods are available in telescopic and put-together options. In keeping with the latest trends many rods now have sensitive tips for increased bite detection and all models offer excellent casting performance.





### 3-PIECE SURF

236	SPEEDMASTER SURF HYBRID	<b>NEW</b>
237	AERLEX SURF HYBRID	<b>NEW</b>
238	ULTEGRA TUBULAR / SOLID TIP	
	VENGEANCE TUBULAR / SOLID TIP	
	ALIVIO TUBULAR	

### BEACH LEDGERING

239	SPEEDMASTER SURF BEACH	<b>NEW</b>
-----	------------------------	------------

### TELE SURF

240	SPEEDMASTER EX TELE SURF	<b>NEW</b>
	AERLEX TELE SURF	<b>NEW</b>
241	VENGEANCE DX TELE SURF	
	ALIVIO FX TELE SURF	
	SONORA TELE SURF	



# POWERFUL CASTING



NEW

## *SpeedMaster* SURF HYBRID / TUBULAR

- High Modulus Full Carbon blank for lightness and power
- Diaflash construction in the lower part for additional casting performance
- Sensitive hybrid tips (not available on 425T model) for optimal bite detection
- Fuji Fazlite K-type or Fuji Lowrider guides (SMSFH425CXHL / SMSFH405CXHL / SMSFT425CXHL)
- Fuji DPS reel seat for all large surfcasting reels



SMSFH425DXH	4.25m	146cm	3	-	150g
SMSFH425CXH	4.25m	146cm	3	-	200g
SMSFH450DXH	4.50m	156cm	3	-	150g
SMSFH450CXH	4.50m	156cm	3	-	200g
SMSFH425CXHL	4.25m	146cm	3	-	200g
SMSFH405CXHL	4.50m	141cm	3	-	200g
TUBULAR					
SMSFT425CXHL	4.25m	146cm	3	-	200g

SFH450CXH





SFH450DX

# VERSATILE CASTING ACTION

NEW

## AERLEX SURF HYBRID / TUBULAR

- Full Carbon blank provides power and balance
- Fast action for long range casting and sensitivity
- Seaguide XOG, XEOG and Fuji Lowrider guide (ARLXSFH425CXL / ARLXSFH405CXL / ARLXSFT425CXL) options
- SHIMANO DPS reel seat for all surfcasting reels

ARLXSFH425DX	4.25m	146cm	3	-	150g
ARLXSFH425CX	4.25m	146cm	3	-	200g
ARLXSFH450DX	4.50m	156cm	3	-	150g
ARLXSFH450CX	4.50m	156cm	3	-	200g
ARLXSFH425CXL	4.25m	146cm	3	-	200g
ARLXSFH405CXL	4.00m	141cm	3	-	200g
TUBULAR					
ARLXSFT425CXL	4.25m	146cm	3	-	200g



# 3-PIECE SURF RODS / TELESCOPIC



FT450BXI Solid Tip

## ULTEGRA TUBULAR / SOLID TIP

Solid Tip Models

- Hi-Power X construction for reduced blank twist and greater rod strength – a true casting machine
- Fuji Low Rider Alconite (425) / Fuji K-Type Alconite guides (450), both lengths have Fuji Stainless Steel SiC tip guide
- Fuji DPS reel seat
- Cast Control Grip
- Two versions: Tubular Tip and Solid Tip
- Nylon bag



	Length	Tip Length	Sections	Weight	Tip Weight
<b>TUBULAR TIP</b>					
ULTSFT425BXI	4.25m	150cm	3	545g	225g
ULTSFT450BXI	4.50m	158cm	3	583g	225g
<b>SOLID TIP</b>					
ULTSFS425BXI	4.25m	150cm	3	537g	225g
ULTSFS450BXI	4.50m	158cm	3	551g	225g



FT425BXX Solid Tip

## VENGEANCE TUBULAR / SOLID TIP

- Extra strong Full Carbon blanks, capable of fighting big and strong catfish
- Strong DPS reel seat and EVA handle for secure grip
- SHIMANO Hardlite guides
- Rubber bulb butt finish to make fish-playing more comfortable
- Extra strong spinning rods for fishing lures and floats from a boat or the bank



	Length	Tip Length	Sections	Weight	Tip Weight
<b>TUBULAR TIP</b>					
VSFT425BXX	4.25m	148cm	3	586g	225g
VSFT450BXX	4.50m	158cm	3	620g	225g
<b>SOLID TIP</b>					
VSFS425BXX	4.25m	148cm	3	586g	225g
VSFS450BXX	4.50m	158cm	3	620g	225g



425BX

## ALIVIO TUBULAR

- Fast action Composite blank
- Excellent combination of distance casting performance and value for money
- SHIMANO anti-tangle stainless steel Hardlite guides
- SHIMANO DPS-type reel seat



	Length	Tip Length	Sections	Weight	Tip Weight
ALSFT425BX	4.25m	148cm	3	579g	225g
ALSFT450BX	4.50m	158cm	3	665g	225g



# LOW FRICTION

NEW

## SpeedMaster EX TELESCOPIC

- High Modulus Full Carbon blank for lightness and power
- Diaflash construction in the lower part for additional casting performance
- Fast tip action for sensitivity when fishing for small fish
- Fuji Fazlite K-type guides (braid safe) for low friction
- Fuji DPS reel seat for all large surfcasting reels



SMEXSFTE4315	4.30m	161cm	6	-	150g
SMEXSFTE4517	4.50m	161cm	6	-	170g
SMEXSFTE4520	4.50m	161cm	6	-	200g



4517

# POWER & BALANCE



NEW

## AERLEX TELESCOPIC

- Full Carbon blank provides power and balance
- Fast action for long range casting and sensitivity
- Seaguide XEOG guides (braid safe) for low friction
- SHIMANO DPS reel seat for all large surfcasting reels
- Guide protector and cloth bag

					
ARLXSFT4315	4.30m	158cm	6	-	150g
ARLXSFT4517	4.50m	158cm	6	-	170g
ARLXSFT4520	4.50m	158cm	6	-	200g







TE4210

## VENGEANCE DX TELE SURF

- Full Carbon blank with powerful fast action for distance casting
- Corrosion resistant Seaguide Stainless Steel Double Leg guides
- Rubberised painted handle for extra grip in wet conditions
- White tip for good bite indication in low light conditions
- Guide protector for optimal guide protection

VDXSFTE4210	4.20m	154cm	6	480g	100g
VDXSFTE4212	4.20m	154cm	6	510g	120g
VDXSFTE4215	4.20m	154cm	6	510g	150g
VDXSFTE4317	4.30m	154cm	6	518g	170g
VDXSFTE4320	4.30m	155cm	6	525g	200g



TE4217

## ALIVIO FX TELE SURF

- Fast action Full Carbon blank with solid tip for increased sensitivity
- Excellent combination of distance casting performance and value for money
- SHIMANO anti-tangle stainless steel Hardlite guides
- SHIMANO DPS-type reel seat
- Grip paint handle finish for assured grip when casting
- Guide protector for optimal guide protection

ALFXSFTE4010	4.00m	152cm	5	540g	100g
ALFXSFTE4215	4.20m	152cm	5	570g	150g
ALFXSFTE4217	4.20m	152cm	5	598g	170g
ALFXSFTE4220	4.20m	152cm	5	616g	200g
ALFXSFTE4225	4.20m	154cm	5	614g	250g



TE4220

## Sonora™ TELE SURF

- Composite blank is strong, responsive and perfect for the inexperienced surfcaster
- SHIMANO stainless steel Hardlite guides
- SHIMANO DPS-type reel seat
- Grip paint handle finish for assured grip when casting
- Guide protector for optimal guide protection

SONSFTE4215	4.20m	147cm	5	638g	150g
SONSFTE4220	4.20m	147cm	5	679g	200g



## FLY RODS

The Biocraft series offers unique/fine-tuned technology at a hard to beat price point, with a range that covers techniques used in streams, rivers and lakes to target salmon, trout, greyling and pike, to inshore and offshore fishing for sea trout and tuna.





#### TROUT

244	BIOCRAFT XR FLY	<b>NEW</b>
	BIOCRAFT XTC FLY	<b>NEW</b>
	BIOCRAFT XR FLY NYMPH	<b>NEW</b>
	BIOCRAFT XTC FLY NYMPH	<b>NEW</b>
245	BIOCRAFT XR FLY STILLWATER	<b>NEW</b>
	BIOCRAFT XTC FLY STILLWATER	<b>NEW</b>

#### PREDATOR FRESH/SALTWATER

246	BIOCRAFT XR FLY SALTWATER	<b>NEW</b>
	BIOCRAFT XR FLY BIG BUG	<b>NEW</b>
247	BIOCRAFT XTC FLY SALTWATER	<b>NEW</b>
	BIOCRAFT XTC FLY BIG BUG	<b>NEW</b>
248	BIOCRAFT XR FLY BOAT	<b>NEW</b>
	BIOCRAFT XR FLY TUNA	<b>NEW</b>

#### TWO HANDED RODS

249	BIOCRAFT XR FLY SWITCH	<b>NEW</b>
	BIOCRAFT XR FLY SALMON	<b>NEW</b>



# TROUT



NEW

**SINGLE HANDED S-GRADE POWERCORK FLY RODS  
DESIGNED TO FISH TROUT & GREYLING  
ON STREAMS & RIVERS**

## BIOCRAFT XR FLY

- Lightweight High Modulus Full Carbon blank with HPC, Biofibre, Nanosheet and Diaflash
- Fuji SiC K-type combined with lightweight single leg Seaguide XSFG-L guides for the best casting performance
- Seaguide custom reel seat with traditional cork handle
- Velvet bag and hardcase transport tube



8043



8654 Handle

						REEL SEAT
FBXR7633	2.29m	80cm	3	66g	#3	Seaguide UFS
FBXR8043	2.44m	85cm	3	-	#4	Seaguide UFS
FBXR8644	2.59m	69cm	4	71g	#4	Seaguide UFS
FBXR8654	2.59m	69cm	4	-	#5	Seaguide RFS
FBXR9044	2.74m	74cm	4	73g	#4	Seaguide UFS
FBXR9054	2.74m	74cm	4	90g	#5	Seaguide RFS



NEW

**SINGLE HANDED POWERCORK FLY RODS DESIGNED  
TO FISH TROUT & GREYLING ON STREAMS & RIVERS**

## BIOCRAFT XTC FLY

- Strong Full Carbon blank with Biofibre and Diaflash
- Fuji Alconite K-type combined with lightweight single leg Seaguide XSFG-L guides for improved casting performance
- Seaguide reel seat with traditional cork handle
- Velvet bag



8644



9054 Handle

						REEL SEAT
FBXTC7633	2.29m	80cm	3	-	#3	Seaguide VFS
FBXTC8644	2.59m	69cm	4	-	#4	Seaguide VFS
FBXTC9044	2.74m	74cm	4	87g	#4	Seaguide VFS
FBXTC9054	2.74m	74cm	4	95g	#5	Seaguide NFS



## BIOCRAFT XR FLY NYMPH

- Long length sensitive High Modulus Full Carbon blank with HPC, Biofibre, Nanosheet and Diaflash
- Fuji SiC K-type combined with lightweight single leg Seaguide XSFG-L guides for the best casting performance
- Lightweight Seaguide RFS reel seat with traditional cork handle
- Velvet bag and hardcase transport tube

NEW

**SINGLE HANDED S-GRADE POWERCORK FLY RODS FOR  
TROUT & GREYLING ON STREAMS & RIVERS WITH NYMPHS**



1033N

						REEL SEAT
FBXR9823N	2.95m	103cm	3	103g	#2	Seaguide RFS
FBXR1033N	3.05m	106cm	3	109g	#3	Seaguide RFS
FBXR1053N	3.05m	106cm	4	-	#5	Seaguide RFS



## BIOCRAFT XTC FLY NYMPH

- Long length sensitive Full Carbon blank with Biofibre and Diaflash
- Fuji Alconite K-type combined with lightweight single leg Seaguide XSFG-L guides for the best casting performance
- Seaguide NFS reel seat for improved balance, with cork handle
- Velvet bag

NEW

**SINGLE HANDED S-GRADE POWERCORK FLY RODS  
TO FISH TROUT & GREYLING ON  
STREAMS & RIVERS WITH NYMPHS**



1033N

						REEL SEAT
FBXTC1033N	3.05m	106cm	3	108g	#3	Seaguide NFS



9633ST

**NEW**





# BIOCRAFT XR FLY STILLWATER

- Designed to fish trout on lakes and reservoirs using dry and wet flies, streamers and buzzers
- Lightweight High Modulus Full Carbon blank with HPC, Biofibre, Nanosheet and Diaflash
- Fuji SiC K-type combined with strong single leg frame Seaguide XSFG guides for the best line guidance
- Seaguide RFS reel seat with small screw-in S grade Powercork handle
- Velvet bag and hardcase transport tube



9673ST Handle

**SINGLE HANDED S-GRADE POWERCORK FLY RODS DESIGNED TO FISH TROUT ON LAKES & RESERVOIRS USING DRY & WET FLIES, STREAMERS & BUZZERS**

						REEL SEAT
FBXR9663ST	2.90m	101cm	3	-	#6	Seaguide RFS
FBXR9673ST	2.90m	101cm	3	-	#7	Seaguide RFS
FBXR1063ST	3.05m	106cm	3	-	#6	Seaguide RFS
FBXR1073ST	3.05m	106cm	3	-	#7	Seaguide RFS
FBXR1083ST	3.05m	106cm	3	-	#8	Seaguide RFS



1073ST

**NEW**

# BIOCRAFT XTC FLY STILLWATER

- Designed to fish trout on lakes and reservoirs using dry and wet flies, streamers and buzzers
- Strong Full Carbon blank with Biofibre and Diaflash
- Fuji Alconite K-type combined with strong single leg frame Seaguide XSFG guides for frictionless line guidance during the cast
- Seaguide NFS reel seat with small screw-in S grade Powercork handle
- Velvet bag

**SINGLE HANDED S-GRADE POWERCORK FLY RODS DESIGNED TO FISH TROUT ON LAKES & RESERVOIRS USING DRY & WET FLIES, STREAMERS & BUZZERS**

						REEL SEAT
FBXTC1063ST	3.05m	106cm	3	-	#6	Seaguide NFS
FBXTC1073ST	3.05m	106cm	3	127g	#7	Seaguide NFS
FBXTC1083ST	3.05m	106cm	3	129g	#6	Seaguide NFS



# PREDATOR FRESHWATER / SALTWATER



90064SW

**NEW**

## BIOCRAFT XR FLY SALTWATER

- Designed to fish sea trout on rivers and seas using streamers
- Lightweight High Modulus Full Carbon blank with HPC, Biofibre, Nanosheet and Diaflash
- Fuji SiC K-type combined with strong double leg Seaguide SSG guides to cope with tougher conditions
- Seaguide APS reel seat with small screw-in S grade Powercork handle
- Velvet bag and hardcase transport tube

**SINGLE HANDED S-GRADE POWERCORK FLY RODS  
DESIGNED FOR SEA TROUT ON RIVERS & SEAS USING STREAMERS**

					REEL SEAT
FBXR90064SW	2.74m	74cm	4	108g	#6 Seaguide APS
FBXR90074SW	2.74m	74cm	4	-	#7 Seaguide APS



90064SW

**NEW**

## BIOCRAFT XTC FLY SALTWATER

- Designed to fish sea trout on rivers and seas using streamers
- Strong Full Carbon blank with Biofibre and Diaflash
- Fuji Alconite K-type combined with strong double leg Seaguide SSG guides to cope with tougher conditions
- Seaguide PFS reel seat with small screw-in Powercork handle
- Velvet bag

**SINGLE HANDED S-GRADE POWERCORK FLY RODS  
DESIGNED TO FISH SEA TROUT ON RIVERS & SEAS  
USING STREAMERS**

					REEL SEAT
FBXTC90064SW	2.74m	74cm	4	122g	#6 Seaguide PFS
FBXTC90074SW	2.74m	74cm	4	-	#7 Seaguide PFS





90084BBSW

**NEW**

## BIOCRAFT XR FLY BIG BUG SALTWATER

- Designed to fish inshore species, pelagic and tropical fish, but also suitable to target freshwater species like pike
- Strong lightweight High Modulus Full Carbon blank with HPC, Biofibre, Nanosheet and Diaflash
- Fuji SiC K-type combined with strong double leg Seaguide SSG guides to cope with tougher conditions
- Seaguide AFS reel seat with screw-in Winn or S grade Powercork handle
- Velvet bag and hardcase transport tube



90104BBSW and 90124BBSW handle

**SINGLE HANDED FLY RODS  
DESIGNED TO FISH INSHORE SPECIES, PELAGIC & TROPICAL FISH.  
ALSO SUITABLE TO TARGET FRESHWATER SPECIES LIKE PIKE**

						REEL SEAT
FBXR90084BBSW	2.74m	74cm	4	-	#8	Seaguide APS
FBXR90104BBSW	2.74m	74cm	4	-	#10	Seaguide APS
FBXR90124BBSW	2.74m	74cm	4	-	#12	Seaguide APS



90084BBSW

**NEW**

## BIOCRAFT XTC FLY BIG BUG SALTWATER

- Designed to fish inshore species, pelagic and tropical fish, but also suitable to target freshwater species like pike
- Stong Full Carbon blank with Biofibre and Diaflash
- Fuji Alconite K-type combined with strong double leg Seaguide SSG guides to cope with tougher conditions
- Seaguide PFS reel seat with screw in Winn or Powercork handle
- Velvet bag



90104BBSW and 90124BBSW handle

**SINGLE HANDED FLY RODS  
DESIGNED TO FISH INSHORE SPECIES, PELAGIC & TROPICAL FISH.  
ALSO SUITABLE TO TARGET FRESHWATER SPECIES LIKE PIKE**

						REEL SEAT
FBXTC90084BBSW	2.74m	74cm	4	132g	#8	Seaguide PFS
FBXTC90104BBSW	2.74m	74cm	4	129g	#10	Seaguide PFS
FBXTC90124BBSW	2.74m	74cm	4	178g	#12	Seaguide PFS



# PREDATOR FRESHWATER / SALTWATER



8383PB

NEW

## BIOCRAFT XR FLY PREDATOR BOAT

- Designed to fish freshwater predators like pike from the boat
- Strong, lightweight High Modulus Full Carbon blank with HPC, Biofibre, Nanosheet and Diaflash
- Fuji SiC K-type combined with strong double leg Seaguide SSG guides to cope with tougher conditions
- Seaguide AFS reel seat with small screw-in S grade Powercork handle
- Velvet bag and hardcase transport tube

SINGLE HANDED S-GRADE POWERCORK FLY RODS  
DESIGNED TO FISH FRESHWATER PREDATORS  
LIKE PIKE FROM A BOAT

						REEL SEAT
FBXR8373PB	2.51m	88cm	3	103g	#7	Seaguide AFS
FBXR8383PB	2.51m	88cm	3	104g	#8	Seaguide AFS
FBXR8393PB	2.51m	88cm	3	105g	#9	Seaguide AFS



83152TU

NEW

## BIOCRAFT XR FLY TUNA

- Designed to target big pelagic species like tuna from the boat with streamers
- Ultra strong 2 piece Full Carbon blank with HPC, Biofibre, Nanosheet and Diaflash
- Fuji SiC K-type combined with strong double leg Seaguide SSG guides to cope with high friction of the line during high speed fights
- Seaguide AFS reel seat with with screw-in Winn handle
- Velvet bag and hardcase transport tube

SINGLE HANDED WINN-GRIP FLY ROD  
DESIGNED TO TARGET BIG PELAGIC SPECIES  
LIKE TUNA FROM THE BOAT WITH STREAMERS

						REEL SEAT
FBXR83152TU	2.51m	88cm	2 (SH)*	185g	#15	Seaguide AFS





# TWO-HANDED



NEW

11684SH

## BIOCRAFT XR FLY SWITCH

- Designed to fish on salmon, trout and sea trout on rivers using streamers, wet flies and nymphs
- Long length High Modulus Full Carbon blank with HPC, Biofibre, Nanosheet and Diaflash
- Fuji SiC K-type combined with strong double leg Seaguide SSG guides to cope with tougher conditions
- Strong Seaguide AFS reel seat with double handed S-grade powercork handle
- Velvet bag and hardcase transport tube

DOUBLE HANDED S-GRADE POWERCORK FLY RODS  
DESIGNED TO FISH SALMON, TROUT & SEA TROUT  
ON RIVERS USING STREAMERS, WET FLIES & NYMPHS

						REEL SEAT
FBXR11664SH	3.51m	93cm	4	-	#6	Seaguide AFS
FBXR11684SH	3.51m	93cm	4	-	#8	Seaguide AFS



NEW

140094SL

## BIOCRAFT XR FLY SALMON

- Designed to fish on salmon, steelhead and sea trout on rivers using streamers, wet flies and tube flies
- Long length High Modulus Full Carbon blank with HPC, Biofibre, Nanosheet and Diaflash
- Fuji SiC K-type combined with strong double leg Seaguide SSG guides to cope with tougher conditions
- Strong Seaguide AFS reel seat with double handed S-grade powercork handle
- Velvet bag and hardcase transport tube

DOUBLE HANDED S-GRADE POWERCORK FLY RODS  
DESIGNED TO FISH SALMON, STEELHEAD & SEA TROUT  
ON RIVERS USING STREAMERS, WET FLIES & TUBE FLIES

FBXR136084SL	4.11m	108cm	4	-	#8
FBXR140094SL	4.27m	111cm	4	227g	#9
FBXR15010114SL	4.57m	119cm	4	259g	#10-11



## BLANK TECHNOLOGY

### SPIRAL X CORE

SHIMANO's unique and patented SPIRAL X CORE construction consists of three layers: a first layer of carbon tape that spirals tightly around the blank in a diagonal direction, a middle sheet of carbon made out of vertical fibres and an outer layer comprising carbon tape that tightly spirals the blank in the opposite direction to the first layer. By using carbon tape, instead of a conventional horizontal fibre sheet, SPIRAL X enhances torsional rigidity without adding extra weight. SPIRAL X CORE makes use of the same construction as SPIRAL X, with the addition of a Nano resin distribution technology in the carbon tape. Nano resin technology distributes the resin more evenly through the carbon fibres resulting in a stronger, lighter rod. SPIRAL X CORE has 1.4 times better anti-twist capabilities and 2.5 times more compression rigidity compared to SPIRAL X.

### SPIRAL X

SHIMANO's unique and patented SPIRAL X construction consists of three layers: a first layer of carbon tape that spirals tightly around the blank in a diagonal direction, a middle sheet of carbon made out of vertical fibres and an outer layer comprising carbon tape that tightly spirals the blank in the opposite direction to the first layer. By using carbon tape, instead of a conventional horizontal fibre sheet, SPIRAL X enhances torsional rigidity without adding extra weight. This construction results in less overlapping of material, which would normally result in a spine and weak spots.

### HI-POWER X

SHIMANO's HI-POWER X construction, uses different carbon layers to create the blank. The outermost layer of carbon tape is diagonally wrapped in opposite directions, which forms an array of "X" shapes. The width of the tape, its winding angle and the part of the rod being wrapped are finely-tuned according to the rods intended use. The flexibility allows SHIMANO to adjust these wraps during construction for precise actions, enhanced overall strength and increased twist resistance. In short, HI-POWER X construction delivers sharp and crisp rod control.

### NANOPITCH

With NANOPITCH manufacturing technology SHIMANO wraps a compression tape, with high precision, over the carbon blank before the curing (heating) process. The NANOPITCH method enables the carbon on the mandrel to be compressed extremely firmly, with uniform pressure, creating circularity pressure which contributes greatly to overall rod strength. NANOPITCH is always applied in combination with the SPIRAL X CORE blank construction to maximize rod performance.

### HIGH PRESSURE CARBON

SHIMANO HIGH PRESSURE CARBON (HPC) is a process which creates stronger, more responsive blanks. Pressure is applied with a compression tape to the blank surface before curing (heating), which evenly distributes the resin through the carbon fibre matrix.

### NANOSHEET

NANOSHEET is a multiple carbon sheet construction, which incorporates Nano resin distribution technology. The resin, which holds the different carbon fibres together, is distributed more evenly across the carbon fibres, resulting in a stronger and more light weight rod, with less potential defects and weak spots.

### BIOFIBRE

SHIMANO's unique BIOFIBRE construction improves overall rod strength and resistance to shock whilst producing increased lifting power in the tip.

### GEOFIBRE

GEOFIBRE is a naturally derived component that provides rigidity and high tensile strength when added to rods in the lower to mid-price rod band.

### DIAFLASH

With SHIMANO's DIAFLASH construction, the outermost layer of the butt section is diagonally wrapped in opposite directions with carbon tape, which forms an array of "X" shapes. The width of the tape, its winding angle and the part of the rod being wrapped are fine-tuned according to the rods intended use. DIAFLASH is a reinforced structure that prevents twisting of the butt section in situations where high-intensity pressure is applied.

### TWIST CONTROL

An anti-twist blank construction process which is applied to Big Game saltwater rods.

### MUSCLE CARBON

MUSCLE CARBON is a high-performance material that reduces the gaps between fibres, by bundling carbon filaments together at a higher density than traditional carbon sheet. This reduces the amount of resin need to fill the gaps in the carbon matrix during the curing process.

### MUSCLE LOOP

MUSCLE LOOP is formed using a spiral carbon tape, wrapped on the outside of the blank, which reduces the natural 'spine' of the blank and also improves strength. This helps prevent the blank from distorting under extreme pressure.

## GRIP TECHNOLOGY

### FULL CARBON MONOCOQUE

The FULL CARBON MONOCOQUE grip is an evolution of the Carbon Monocoque grip and features up to 28% increased sensitivity. Normally the grip section, behind the reel seat is made of EVA or cork, however with the Full Carbon Monocoque grip this section is also moulded from a hollow carbon structure. This greatly improves the lightness and ability to detect vibrations transmitted to the hand. In addition, the carbon grip section is cushioned to prevent slipping with the hand.

### CARBON MONOCOQUE

The CARBON MONOCOQUE grip is a one-piece hollow carbon construction, which is integrated seamlessly into the rod blank. The remarkably lightweight handle is stiffer than traditional rod construction, reduces the overall weight of the rod and also increases vibration transmission.

## REEL SEAT TECHNOLOGY

### CI4+

The CI4+ reel seat is a moulded one-piece composite construction that is very lightweight, strong and resistant to distortion. The composite is one of the strongest materials SHIMANO use and is over 1.5 times stronger than traditional composite materials. CI4+ is also water resistant and not affected by corrosion, making it suitable for salt water use.

## TIP SECTION TECHNOLOGY

### TAFTEC ALPHA

TAFTEC ALPHA tips utilise a pre-stretched T-3500 directional yarn fibre with low resin saturation. This directional alignment of the fibres in the solid tip results in much less damage during the grinding process and results in a spineless construction. In tests it has been shown to be much stronger, lower in weight, faster in action and more sensitive.

### EXCITE TOP

EXCITE TOP is a special tip that enhances the shake performance of lures and contributes to sensitivity. The tip section is tapered and slightly heavier at the top. This construction expands the swing width of the tip, enabling shaking with an automatic feeling. The movement seen by the eyes, and the sensitivity transmitted to the hands, is greatly improved.

### SOFTUBE TOP

The SOFTUBE TOP provides the sensitivity of an ultra fine solid carbon tip with the lightness of a hollow/tubular tip construction. This tip construction can be found on models where sensitivity and finesse are both important requirements.

## ROD ACTIONS

### EXTRA-FAST ACTION

A very light and sensitive tip facilitates an effective transfer of energy resulting in effortless pin-point casts, near or far. This action will make any angler a more effective caster.

### FAST ACTION

Fast action rods have a light tip that transfers into the power quickly for positive hook sets and effortless repetitive casting. If you are looking for a lure rod to do it all, a fast action rod is a solid choice.

### MODERATE-FAST ACTION

The deeper flex associated with this action allows the angler to control the energy of the fish with additional confidence. This action offers an unsurpassable ability to land the majority of fish hooked on the lightest tackle.

### MODERATE ACTION

Whenever an angler needs the perfect action to absorb the surging power of a fish delivering aggressive headshakes or quick runs, a moderate action rod neutralizes their power.

## S.A.S. TECHNOLOGY

### SHIMANO ALIGNMENT SYSTEM

SHIMANO ALIGNMENT SYSTEM is a system to optimise blank action. During the production process, the spine of the blanks is marked on the sections of a telescopic rod.

## GUIDES

### FUJI GUIDES

Fuji guides are world famous for their quality. Available in many different options, including the famous 'K-type' anti-tangle design, Fuji guides are generally fitted to higher performance rods.

### KIGAN 3D GUIDES

Kigan 3D guides are becoming increasingly popular, especially on specimen rods where the lightweight, strong frames and zirconia linings aid distance casting.

### SEAGUIDE GUIDES

Seaguide guides are becoming increasingly popular and offer reliable, friction reducing performance and reliability. Generally fitted to mid-priced rods within the SHIMANO range.

### HARDLITE GUIDES

Hardlite guides have been used by SHIMANO for many years and are proven to be reliable across a wide range of rod applications. Offering excellent value, they are fitted to lower priced rods.

# CARP LUGGAGE FEATURES



## LUGGAGE

The ranges of SHIMANO luggage have some of the most radical and ground-breaking designs ever seen in the angling industry.

Just like our rods and reels, great care and attention has been paid to the needs of anglers. Within the ranges, innovative products have been created with the specific aim to meet the needs and aspirations of specialist and specimen anglers alike.

### CARP LUGGAGE

254 TRENCH GEAR RANGE

258 TACTICAL GEAR RANGE

262 SYNC GEAR RANGE

### ACCESSORIES

265 LANDING NET HANDLES **NEW**

266 CARP CARE

### PREDATOR LUGGAGE

268 YASEI RANGE **NEW**

### GENERAL LUGGAGE

272 ALL ROUND LUGGAGE

273 EVA & LURE LUGGAGE



# CARP LUGGAGE

**BASED AROUND THE ORGANISED COMPACT DESIGN PRINCIPLE, THERE'S A PLACE FOR EVERYTHING FROM INSIDE TO OUT.**

TRENCH  
GEAR

TACTICAL  
GEAR

SYNC  
GEAR

TRICAM

ORGANISED  
COMPACT  
DESIGN

**Tricam** is a unique, carp specific camo design, developed on a new, hard wearing 600 Denier outer material and 210 Denier lining. Introduced specifically for the Tactical Gear, Trench Gear and Sync Gear luggage range.

The **Organised Compact Design** system allows the angler to choose from numerous specialised accessory cases that fit, jigsaw-like, into one of the many compatible carryalls. This gives the option to change them around for specific venues or the length of time fishing.

**Organised Compact Design** also has options for connecting external bags. Webbing loops have been incorporated down the front of most main bags for attaching smaller pouches whilst elastic loops can be found on top of many bags, ideal for holding bite alarms on sticks. Webbing Straps can also be found on larger bags, for attaching food bags and bivvy tables.

HD ZIPPERS

**HD Zippers** can handle the most extreme abuse to ensure SHIMANO luggage lives up to the expectations of the most demanding anglers. HD Zippers have been thoroughly tested for strength and easy of use.

POWER STITCH

**Power Stitching** is widely used throughout the SHIMANO luggage range. This involves double stitched seams which produce increased strength at all the major stress areas ensuring longevity and reducing the chance of failure.

AERO Quiver  
ADVANCE

The **Aero Quiver** system is simply based around an adjustable strap that components can be clipped onto. Like the existing Aero Quiver strap, the new Aero Quiver Advance strap has an improved mesh padding for extra comfort and allows up to 10 different products to be attached, offering countless variations.



## TRENCH GEAR

SHIMANO's Organised Compact Design system was one of the first modular tackle management luggage systems. Originally based around tackle cases fitting perfectly into larger outer carryalls, the system has now evolved into a complete inside to out system.

The TRIBAL luggage range now comprises Trench outer bags, Sync inner bags and a Trench Barrow which is designed to work perfectly with the all TRIBAL luggage.

All Trench items now feature the TriCam premium 600D outer shell with a contrasting 210D lining material.





## COMPACT CARRYALL

- Organised Compact Design takes 4 large or 8 small cases plus large tackle box pocket
- Organised Compact Design base unit and outer fitting
- Barrow fitting



SHTTG01

42cm x 26cm x 40cm



## LARGE CARRYALL

- Organised Compact Design takes 6 large or 12 small cases plus large tackle box pocket
- Organised Compact Design base unit and outer fitting
- Barrow fitting



SHTTG02

63cm x 26cm x 40cm



## RUCKSACK

- Organised Compact Design takes 4 large or 8 small cases plus large tackle box pocket
- Organised Compact Design base unit and outer fitting
- Barrow fitting



SHTTG05

42cm x 26cm x 40cm



## CLOTHING BAG

- Clean and dirty clothes separator
- Wide opening zipper
- Compression straps
- Toiletries pocket
- Heavy duty base



SHTTG26

67cm x 30cm



## STALKER BAG

- Organised Compact Design base unit and D ring attachment
- Barrow fitting
- Catapult loop
- 2 mesh side pockets



SHTTG20

42cm x 26cm x 27.5cm



## CAMERA BAG

- Accommodates 2 Camera bodies, 12 lenses, 1 tripod
- Extreme internal padding
- Watertight stormflap lid with compression straps for tripod



SHTTG17

44cm x 26cm x 27.5cm



## FOOD BAG

- Barrow fitting
- Cutlery pocket with utensils for 2 people
- Thermal centre compartment
- Watertight storm flap lip with compressions straps



SHTTG19

63cm x 26cm x 27.5cm



## COOLER BAG

- Organised Compact Design outer fitting
- Barrow fitting
- Watertight storm flap lid with compression straps
- Freezer friendly thermal lining



SHTTG18

42cm x 26cm x 27.5cm



## BUZZER BAR BAGS

- Barrow and rucksack fitting
- Extreme internal padding
- External clear pocket and external stick storage



SHTTG15

3 Rod - 45cm x 22cm x 8cm

SHTTG16

4 Rod - 65cm x 22cm x 8cm

# TRENCH GEAR



12ft 3+2 rods

13ft 3+2 rods



12ft

13ft

## ROD HOLDALLS

- Aero Quiver Advanced bag connection system
- Barrow fitting
- Lead pocket and waterproof net pocket
- Zip closure away from reel line
- High durability skid base



SHTTG07  
SHTTG08

12ft 3+2 rods - 200cm x 32cm x 25cm  
13ft 3+2 rods - 210cm x 32cm x 25cm

## PADDED ROD SLEEVES

- Aero Quiver Advanced bag connection system
- Barrow fitting
- Extreme internal padding
- Lead pocket and waterproof net pocket
- Zip closure away from reel line



SHTTG12  
SHTTG13

12ft - 195cm x 23cm  
13ft - 210cm x 27cm





## STINK & STICK BAG

- Aero Quiver Advanced bag connection system
- Barrow fitting
- Watertight welded design
- External storm / marker pole pockets



SHTTG11

23cm x 140cm



## TIP PROTECTOR SLING

- Aero Quiver Advanced bag connection system
- Barrow fitting
- Elasticated strap to fit 12ft and 13ft rods
- Padded reel separator for 2 rods



SHTTG10

30cm x 30cm x 24cm

# TACTICAL GEAR



## TACTICAL GEAR

Tactical Gear is a more price conscious range of TRIBAL Carp luggage for the angler that prefers the traditional olive/brown colours. Incorporating many of the premium features found on Trench Gear but with a more focus on design simplicity, Carp care products such as mats come in smaller sizes suitable for UK fisheries and EU Run waters.

ORGANISED  
COMPACT  
DESIGN

AERO  
Saver

zippers

POWER  
stick





## COMPACT CARRYALL

- Organised Compact Design Base Unit
- Organised Compact Design Outer Fitting
- Barrow Fitting - Centre
- Lid Compression Straps
- Internal Mesh Pocket



SHTXL01

42cm x 26cm x 27.5cm



## LARGE CARRYALL

- Organised Compact Design Base Unit
- Organised Compact Design Outer Fitting
- Barrow Fitting - Centre
- Lid Compression Straps
- Internal Mesh Pocket



SHTXL02

63cm x 26cm x 27.5cm



## FULL COMPACT CARRYALL

- Organised Compact Design Base Unit
- Organised Compact Design Outer Fitting
- Barrow Fitting - Centre
- Fully Loaded With 4 X Small Case, 2 X Large Case



SHTXL04

63cm x 26cm x 27.5cm



## RUCKSACK

- Organised Compact Design Base Unit
- Organised Compact Design Outer Fitting
- Barrow Fitting - Centre
- Lid Compression Straps
- Internal Mesh Pocket



SHTXL05

42cm x 26cm x 27.5cm



## COOLER BAIT BAG

- Thermal Centre Compartment
- Barrow Fitting - Centre



SHTXL21

31.5cm x 26cm x 27.5cm



## BREW KIT & SNACK BAG

- Thermal Centre Compartment perfect for bottled milk
- Barrow Fitting - Centre
- Spoon Loop



SHTXL22

31.5cm x 26cm x 27.5cm



## COMPACT FOOD BAG

- Cutlery Pocket With Utensils For 2 People
- Thermal Centre Compartment
- Barrow Fitting - Centre



SHTXL23

42cm x 26cm x 27.5cm



## BUZZER BAR BAG

- Barrow - Front/Rear & Rucksack Fitting
- Internal Padding
- External Clear Receiver Pocket
- External Stick Storage On Back
- 2 Internal Accessory Pockets



SHTXL24

46cm x 22cm x 40cm



## TIP TOP ROD BANDS

- Aero Quiver Basic Bag Connection System
- Barrow Fitting - Sides



SHTXL20

Extends to fit most models



## ROD HOLDALLS

- Aero Quiver Basic Bag Connection System
- Lead Pocket, Net Pocket
- Barrow Fitting - Sides
- Zip Closure Away From Reel Line



SHTXL11	12ft 2 rods - 200cm x 33cm x 20cm
SHTXL12	12ft 3 rods - 200cm x 33cm x 25cm
SHTXL13	13ft 3 rods - 210cm x 33cm x 25cm
SHTXL14	13ft 4 rods - 210cm x 33cm x 30cm

## PADDED ROD SLEEVES

- Aero Quiver Basic Bag Connection System
- Lead Pocket
- Barrow Fitting - Sides
- Part Padded For Protection



SHTXL16	10ft - 167cm x 28cm
SHTXL17	3/4 - 153cm x 22cm
SHTXL18	12ft - 195cm x 27cm
SHTXL19	13ft - 210cm x 27cm

## TX LITE 2+1 ROD BAG

- Aero Quiver Basic Bag Connection System
- Lead Pocket & Net Pocket
- Barrow Fitting - Sides
- Zip Closure Away From Reel Line
- Rod Hood



SHTXL32

110cm x 62cm



## BIVVY BAG

- Aero Quiver Basic Bag Connection System
- External Peg Pocket
- Barrow Fitting - Sides
- External Storm Pole Pockets
- Standard: Fits 1 Man and Smaller Bivvies



SHTXL25

ø20cm x 135cm (Standard)

## BROLLY BAG

- Aero Quiver Basic Bag Connection System
- External Peg Pocket
- Barrow Fitting - Sides
- External Storm Pole Pockets



SHTXL08

ø30cm x 190cm

## STINK BAG

- Aero Quiver Basic Bag Connection System
- Watertight Welded Design
- Barrow Fitting - Sides



SHTXL09

145cm x 23cm



# SYNC GEAR

Designed to fit perfectly into Trench Gear luggage, Sync Gear is the ideal solution for storing smaller items of tackle in an organised way.





### SMALL ACCESSORY CASE

- Organised Compact Design internal bag
- Fold down internal separators
- Padded lining



SHTSC01

27cm x 12.5cm x 10cm



### LARGE ACCESSORY CASE

- Organised Compact Design internal bag
- Fold down internal separators
- Padded lining



SHTSC02

27cm x 25cm x 10cm



### XL ACCESSORY CASE

- Organised Compact Design internal bag
- Fold down internal separators
- Padded lining



SHTSC03

27cm x 25cm x 20cm



### MAGNETIC SECURITY CASE

- Organised Compact Design internal bag
- Fold down internal separators
- Padded lining
- Strong magnetic bivvy wall fitting



SHTSC05

27cm x 12.5cm x 10cm



### FOOD SET

- Organised Compact Design internal bag
- Fully loaded kitchen ware for 2 people
- Additional space for stove and gas



SHTSC07

27cm x 25cm x 10cm



### RIG & BITS CASE

- Organised Compact Design internal bag
- Fold down internal separators
- Internal storage pockets
- 3 small terminal tackle boxes included



SHTSC11

27cm x 12.5cm x 10cm



### LEAD & BITS CASE

- Organised Compact Design internal bag
- 2 Internal zippered lead pockets
- Credit card sleeves for accessories
- Spool storage pockets



SHTSC10

27cm x 12.5cm x 10cm



### SCALE CASE

- Organised Compact Design internal bag
- Extreme internal padding
- Internal collapsible water bucket supplied
- Weigh bar internal pocket



SHTSC13

27cm x 25cm x 10cm



### SPOOL CASE

- Organised Compact Design internal bag
- Rigid protective body
- 4 protective spool socks



SHTSC14

27cm x ø10cm

# SYNC GEAR & LANDING NET HANDLES



## HOOKBAIT CASE

- Organised Compact Design, interne tas
- Inclusief 6 x smalle aasbakjes



SHTSC08

27cm x 12.5cm x 10cm



## PVA CASE

- Organised Compact Design internal bag
- Funnel web storage pocket
- Elasticated tool loops
- Watertight PVA bag storage box



SHTSC12

27cm x 12.5cm x 10cm



## SMALL POUCH

- Organised Compact Design external bag
- Detachable strap



SHTSC18

14cm x 20cm



## BAITING CADDY

- Organised Compact Design internal bag
- Concealed waist band
- Freezer friendly thermal lining
- Internal wings limiting bait spillage



SHTSC20

27cm x 12.5cm x 10cm



## 5KG / 10KG AIRDRY BAG

- Barrow fitting
- Drop out airmesh
- Airdry and bait zipper access



SHTSC21

5KG - 36cm x 36cm

SHTSC22

10KG - 55cm x 40cm



## BAIT BUCKET

- Square bucket with Tricam pattern
- Keeps all you gear dry and your boilies fresh
- Barrow fitting - centre



SHTSC35

26cm x 29cm x 29.5cm

## BIVVY TABLE

- Barrow fitting
- Twist lock adjustable legs
- Folding legs
- Supplied with a bag



SHTSC15

50cm x 30cm x 21cm







## TRIBAL LANDING NET

- 42ins triangular net with 1.8m reinforced carbon pole
- Fish friendly deep soft mesh with a flat base
- Super strong metal spreader block with isotope insert
- Stink bag supplied

TRBLN180

180cm



**NEW**

Tribal TX Extreme

## TRIBAL TX LANDING NET

- Stiff, fast taper Full Carbon handle (TX Plus)  
Ultra stiff, fast taper 3K reinforced handle (TX Extreme) with shrink wrap grips
- 2 section put-in handle with 76cm extension for versatility
- Stiff 42" carbon arms push into CNC alloy spreader block
- High quality heavy duty mesh with additional reinforcing
- Compact storage length of 120cm

TXPLNP42

2+2 Piece TX Plus 42" (190cm)

TXELNP42

3+2 Piece TX Extrem 42" (266cm)



Aero Pro Light

Aero Pro Power

Aero Pro Multi

## AERO PRO LANDING NET HANDLES

- Designed to accompany the Aero rod range
- Available in different lengths and stiffness of handles ensuring competitive coarse anglers can overcome all situations
- An ultra-light 'Light' version, perfect for natural fishing
- An ultra stiff 'Power' version, perfect for handling bigger fish
- Clever section tapers push balance to the butt end making the handle feel lighter

AEPROLNH30L

Net Handle Light (300cm)

AEPROLNH30P

Net Handle Power (300cm)

AEPROMLNH3045

Net Handle Multi inc. ext (250-450cm)

AEPROLNHEXT

Handle Extension (50cm)



## BEASTMASTER LANDING NET POLE

- Extra-strong landing net handles suited to commercial fisheries
- Threaded cap offers extra strength

BMAXLNP450

4.5m

# CARP CARE



## CALMING RECOVERY SLING

- Aero Quiver Advanced bag connection system
- Barrow fitting
- Watertight bag
- Fish calming retention sacking
- Cord, float and bankstick attachment
- Hi-vis reflective tape on floats

SHTTG21

120cm x 60cm



## EURO PROTECTION MAT & PROTECTION MAT

- Aero Quiver Advanced bag connection system
- Barrow fitting
- Quick transport compression clips
- Rigid sides and extensive padding
- Stay wet fish-safe mesh cover

SHTTG22

125cm x 80cm x 22cm (Euro)

SHTTG23

110cm x 76cm x 22cm (Regular)



## EURO STRESS FREE MAT

- Aero Quiver Advanced attachment
- Quick fold design for instant setup/breakdown time
- Built-in bag
- Padded sides for fish safety
- End supports for easy use with retainers

SHTTG24

120cm x 80cm x 38cm



## EURO CRADLE

- Aero Quiver Advanced attachment
- Quick fold design for instant setup/breakdown time
- Curved easy pick up and photo friendly frame
- Stay wet, summer safe mesh cover
- Padded bars for fish safety

SHTTG25

120cm x 80cm



## FLOATING RECOVERY SLING

- Aero Quiver Basic Bag Connection System
- Watertight Welded Design Containment Bag
- Barrow Fitting - Sides
- Full Water Circulation Design
- Cord, Float And Bankstick Fitting

SHTXL26

115cm x 60cm



## FLAT MAT

- Aero Quiver Basic Bag Connection System
- Watertight Built In Containment
- Barrow Fitting - Sides

SHTXL27

110cm x 76cm



## STRESS FREE MAT

- Aero Quiver Basic Bag Connection System
- Quick Fold Design For Instant Setup/Breakdown Time
- Barrow Fitting - Centre
- Built In Bag
- Padded Sides For Fish Safety

SHTXL30

110cm x 62cm x 25cm



## CRADLE

- Aero Quiver Basic Bag Connection System
- Quick Fold Design For Instant Setup/Breakdown Time
- Barrow Fitting - Centre
- Curved Easy Pickup And Photo Friendly Frame
- Stay Wet Summer Safe Mesh Cover

SHTXL31

110cm x 62cm x 25cm



## WEIGH MAT

- Aero Quiver Basic Bag Connection System
- Tacklebox Pocket
- Barrow Fitting - Sides
- Zip Up Side For Weighing

SHTXL33

87cm x 76cm x 35cm

# PREDATOR LUGGAGE FEATURES



# YASEI

## PREDATOR LUGGAGE

The NEW Yasei luggage is exactly what the serious Predator angler has been waiting for! Manufactured from the highest grade materials and components but with designs that simplify the experience and increase speed and access for the angler.

The OCD System enables multiple, smaller lure cases to be added to the shoulder straps or to the outer side of the main bags in the range, minimising the time it takes to change your lure or end tackle. Clip systems are also included so that measuring mats are always at hand.

The Aero Quiver Advanced System is the best for comfort and breathability, HD Anti Rust zippers can handle the most extreme abuse and PowerStitching ensures all critical areas offer maximum durability.



# PREDATOR LUGGAGE

**BASED AROUND THE ORGANISED COMPACT DESIGN PRINCIPLE, EVERYTHING AN ANGLER NEEDS IS AT HAND.**



## ORGANISED COMPACT DESIGN

**Organised Compact Design** has options for connecting to external bags. Webbing straps and loops can be found on the larger bags for attaching multiple, smaller lure cases whilst clip systems can be found on the front and sides of many bags, ideal for holding mats.

## HD ZIPPERS

**HD Zippers** can handle the most extreme abuse to ensure SHIMANO luggage lives up to the expectations of the most demanding anglers. HD Zippers have been thoroughly tested for strength and ease of use.

## POWER STITCH

**Power Stitching** is widely used throughout the SHIMANO luggage range. This involves double stitched seams which produce increased strength at all the major stress areas ensuring longevity and reducing the chance of failure.

## AERO Quiver ADVANCE

The **Aero Quiver** system is simply based around an adjustable strap that components can be clipped onto. **The Aero Quiver Advance** strap has an improved mesh padding for extra comfort and allows connectivity to the rest of the Aero Match Luggage range.



**NEW**

## STREET BAG

- Supplied with x1 Large Plano Lure box
- OCD Connection on front and sides for attaching Yasei Lure cases
- Magnetic closure
- Zipped compartment for accessories



SHYS01

37.5cm x 10cm x 28cm



**NEW**

## RUCKSACK

- Supplied with x3 Medium Plano Lure Boxes
- OCD Connection on front and sides for attaching Yasei Lure cases
- Front pocket for accessories or an additional medium tackle box (not supplied)
- Tool pocket in quick access positioning
- Large, waterproof, roll top main compartment
- Easy access tackle box compartment



SHYS06

27cm x 15cm x 45cm



**NEW**

## CARRYALL LARGE

- Supplied with x4 Large Plano Lure boxes in a quick access, stay open pocket
- OCD Connection on front for lure packs and trace cases
- x3 Zipped external pockets
- Water resistant base



SHYS08

25.5cm x 36cm x 24cm



**NEW**

## CARRYALL MEDIUM

- Supplied with x3 Medium Plano Lure boxes in a quick access, stay open pocket
- OCD Connection on front for lure packs and trace cases
- x3 Zipped external pockets
- Water resistant base



SHYS07

40cm x 29cm x 20cm

NEW

## SLING BAG MEDIUM

- Supplied with x2 Medium Plano Lure boxes
- OCD Connection on front and sides for attaching Yasei smaller cases
- x2 Zipped compartments with internal pockets
- Outer accessory pockets for quick and easy access



SHYS02

28cm x 15cm x 21cm



NEW

## REEL CASE

- Designed to fit 1000-5000 sized reels
- For use with rod and reel set-up
- Includes a separate handle pocket for reels without folding handles
- OCD Connection on the rear for Trace Case



SHYSS01

14.5cm x 5.5cm x 12.5cm



NEW

## TRACE CASE

- Ultra compact design for quick and easy access
- Includes x10 internal zip lock sleeves for storing traces, softbaits, dropshot leads
- OCD Connection loop on the back for connecting to other bags and straps in the range



SHYSS05

11cm x 4cm x 12cm



NEW

## LIGHT LURE CASE

- Ultra compact storage
- x2 Foam sided storage panels for small hardbaits and a centre compartment for packets
- OCD Connection loops on the back for connecting to other bags and straps in the range



SHYSS11

19cm x 2.5cm x 11cm



NEW

## BRAG MAT

- Printed measuring mat with measurements up to 150cm
- Velcro folded design for use at either 85cm or 150cm
- Corner 'Nose' pocket to secure the fish's head for accurate measuring
- Rolls up into a neat compact design
- OCD hook for connection to other bags in the range



SHYSS09

150cm x 1.25cm x 30cm



# ALL ROUND LUGGAGE / EVA & LURE LUGGAGE



## DURA DELUXE CARRYALL

- Roomy double zippered main compartment
- 50cm wide front pocket complete with insert EVA net bag
- Two extra large side pockets
- Supplied with an insert EVA Net bag
- Multiple ALL-ROUND Accessory case fit inside
- Sliding shoulder pad and carry handles

SHALLR01

52cm x 37cm x 43cm



## BAIT & BITS BAG

- Compact carryall ideal for all disciplines
- Single large zippered main compartment
- Thermal lined main compartment
- Front zippered pocket for hookbaits and additives
- Tough meshed back pocket
- Sliding shoulder pad and carry handles

SHALLR03

38cm x 32cm x 31cm



## TACKLE BAG

- Two tough mesh pockets, each side
- Front zippered pocket for smaller items
- Sliding shoulder pad and carry handles

SHALLR05

33cm x 26cm x 22cm



## ROD SLEEVES

- Double rod & reel fitting (SHALLR07)
- Triple rod & reel fitting (SHALLR08)
- Full length side pocket
- Stiff protective lining
- Sliding shoulder pad and carry handle

SHALLR07

170cm x 22cm x 22cm

SHALLR08

170cm x 22cm x 22cm



## DOUBLE ROD + HOLDALL

- Soft padded body double compartment ready rod holdall
- Side pocket for umbrella and net handle
- Sliding shoulder pad and carry handle

SHALLR11

175cm x 24cm x 26cm



## ROD BANDS

- Two pieces per pack
- Unique design that incorporates a pocket for storing a method feeder
- Stretchy neoprene for easy tightening

SHALLR06



## STRESS FREE UMBRELLA

- (50in) Nylon Umbrella
- Flat to floor back
- Robust 90° angle lock
- 250cm Opened Diameter

SHALLR12

250cm





## GROUNDBAIT BOWL

- Collapsible groundbait bowl
- Ideal for storing bait or taking groundbait to the bank already mixed
- Semi rigid design for ease of use
- Zippered lid allows easy access
- Carry handles

SHPVC04

20cm x 32cm



## NET BAGS

- Watertight net bag ideal for transporting wet keepnets and landing net heads
- Soft high quality waterproof material
- Folds flat and can stored away on windy days
- Rigid wire opening for easy loading of nets
- Adjustable shoulder strap and padded carry handles

SHPVC01

Double - 60cm x 60cm x 15cm

SHPVC02

Triple - 60cm x 60cm x 20cm



## LURE CASES

- Lures can be stored individually or in the their case in separate compartments
- Quick and easy access to all lures
- Made from easy-clean PVC with a moulded polyester lid
- Can be carried on shoulder or waist

SHLCH01A

Medium - 16cm x 19cm x 9cm

SHLCH02

Large - 19cm x 27cm x 15cm



## RIG WALLET

- A stylish rig wallet comprising eight secure fastening vinyl rig sleeves
- Can be attached to other luggage via an integral clip
- Perfect for shaped 'Chod' rig storage
- Easy to clean outer material

SHLCH06

13cm x 13cm x 3cm



## REEL CASE

- A stylish reel case ideal for storing and protecting spinning reels
- Double zipped top panel
- Carbon-look easy to clean outer material

SHLCH03

Medium - 12cm x 16cm x 8cm

SHLCH04

Large - 13cm x 20cm x 11cm



## LINE

As one of the world's foremost reel manufacturers, we know how much punishment fishing lines can take. We have spent many years developing the lines in our range to cope with a wide variety of angling situations from saltwater fishing to snag-infested lakes. Whatever your angling passion or budget, you can be sure there will be something here for you.





**MONO**

276	ALL ROUND MONO
277	SPECIAL USE AERO MONO
278	TROUT COMPETITION MONO
	YASEI PREDATOR MONO
279	SPINNING MONO
	SPECIMEN MONO
280	SALTWATER MONO

**BRAID**

282	KAIRIKI 8
283	KAIRIKI 4
	KAIRIKI G5 <b>NEW</b>
284	POWERPRO
	POWERPRO SUPER SLICK V2
285	POWERPRO DEPTH HUNTER
285	HOW TO GUIDE ON ORDERING LINE





## TECHNIUM

- Triple-core mono specifically designed for increased casting performance
- Extremely low stretch of approximately 12% gives far superior bite detection
- Sinks very rapidly and settles on the contours of the lake bed
- Renowned for its strength and suppleness
- Dark colour blends perfectly to silty bottoms

		Spool	0.16mm 2.60kg	0.18mm 3.20kg	0.20mm 3.80kg	0.22mm 5.00kg	0.25mm 6.10kg	0.28mm 7.50kg	0.30mm 8.50kg	0.35mm 11.50kg	0.40mm 14.00kg
TEC200	200m		✓	✓	✓	✓	✓	✓	✓		
TEC300	300m Premium Box					✓	✓	✓	✓	✓	
TEC(M)(MM)	Premium Box							✓ (650m)	✓ (650m)	✓ (600m)	✓ (450m)
TECQP	Q.Pound Premium Box		✓ (2990m)	✓ (2480m)	✓ (1920m)	✓ (1530m)	✓ (1250m)	✓ (1100m)	✓ (790m)	✓ (790m)	✓ (620m)
TECBLK5000	5000m						✓	✓	✓	✓	✓



## TECHNIUM INVISITEC

- A monofilament that is practically invisible in the water, helping it to blend into any lake bed
- Triple layer construction offers low stretch properties for increased bite detection
- Outstanding strength
- Superb casting properties
- Sinks quickly and stays on the bottom

		Spool	0.14mm 2.20kg	0.16mm 2.70kg	0.18mm 3.30kg	0.20mm 4.20kg	0.22mm 5.30kg
TECINV300	300m			✓	✓	✓	✓
TECINVQPPB	Q.Pound (Prem)				✓(2990m)	✓(2480m)	✓(1920m)
		Spool	0.25mm 6.70kg	0.28mm 7.70kg	0.30mm 9.00kg	0.35mm 12.00kg	0.40mm 15.00kg
TECINV300	300m		✓	✓	✓	✓	✓
TECINVQPPB	Q.Pound (Prem)		✓(1371m)	✓(1330m)	✓(1100m)	✓(790m)	✓(620m)
TECINVBLK5000	5000m		✓	✓	✓	✓	



## EXAGE

- Good value all round monofilament mainline
- Exceptional knot strength
- Perfect for both freshwater and saltwater
- Made in Japan

		Spool	0.12mm 1.30kg	0.14mm 1.80kg	0.16mm 2.30kg	0.18mm 2.90kg	0.20mm 3.40kg	0.22mm 4.40kg
EXG150	150m		✓	✓	✓	✓	✓	
EXG300	300m				✓	✓	✓	
EXG1000	1000m				✓	✓	✓	
EXG5000	5000m					✓		
		Spool	0.25mm 5.50kg	0.30mm 7.50kg	0.35mm 10.40kg	0.40mm 12.90kg	0.50mm 19.00kg	
EXG150	150m		✓	✓	✓	✓		
EXG300	300m		✓	✓	✓	✓		
EXG1000	1000m		✓	✓	✓	✓	✓	
EXG5000	5000m		✓	✓	✓	✓		



## AERO FLOAT

- High quality mono designed for float fishing
- Semi-buoyant enables the line to be used on or just under the surface
- Very soft for effortless casting and float control
- Low stretch for direct contact and faster striking
- 150m length spools for 'one-shot' reel filling

	Spool	0.137mm 1.69kg	0.155mm 2.14kg	0.173mm 2.65kg	0.192mm 3.20kg
AERFL150	150m	✓	✓	✓	✓



## AERO SLICK SILK

- Designed for pole rigs and hooklengths
- Excellent linear and knot strength
- Ultra soft with silky smooth surface for very natural bait presentation
- Low visibility clear colour for minimal fish detection
- Wide range of diameters on 100 metre spools

	Spool	0.076mm 0.57kg	0.086mm 0.74kg	0.096mm 0.914kg	0.104mm 1.08kg	0.114mm 1.27kg	0.123mm 1.48kg
AERSSRH100	100m	✓	✓	✓	✓	✓	✓
	Spool	0.133mm 1.69kg	0.152mm 2.23kg	0.172mm 2.79kg	0.190mm 3.45kg	0.210mm 4.13kg	0.240mm 5.28kg
AERSSRH100	100m	✓	✓	✓	✓	✓	✓

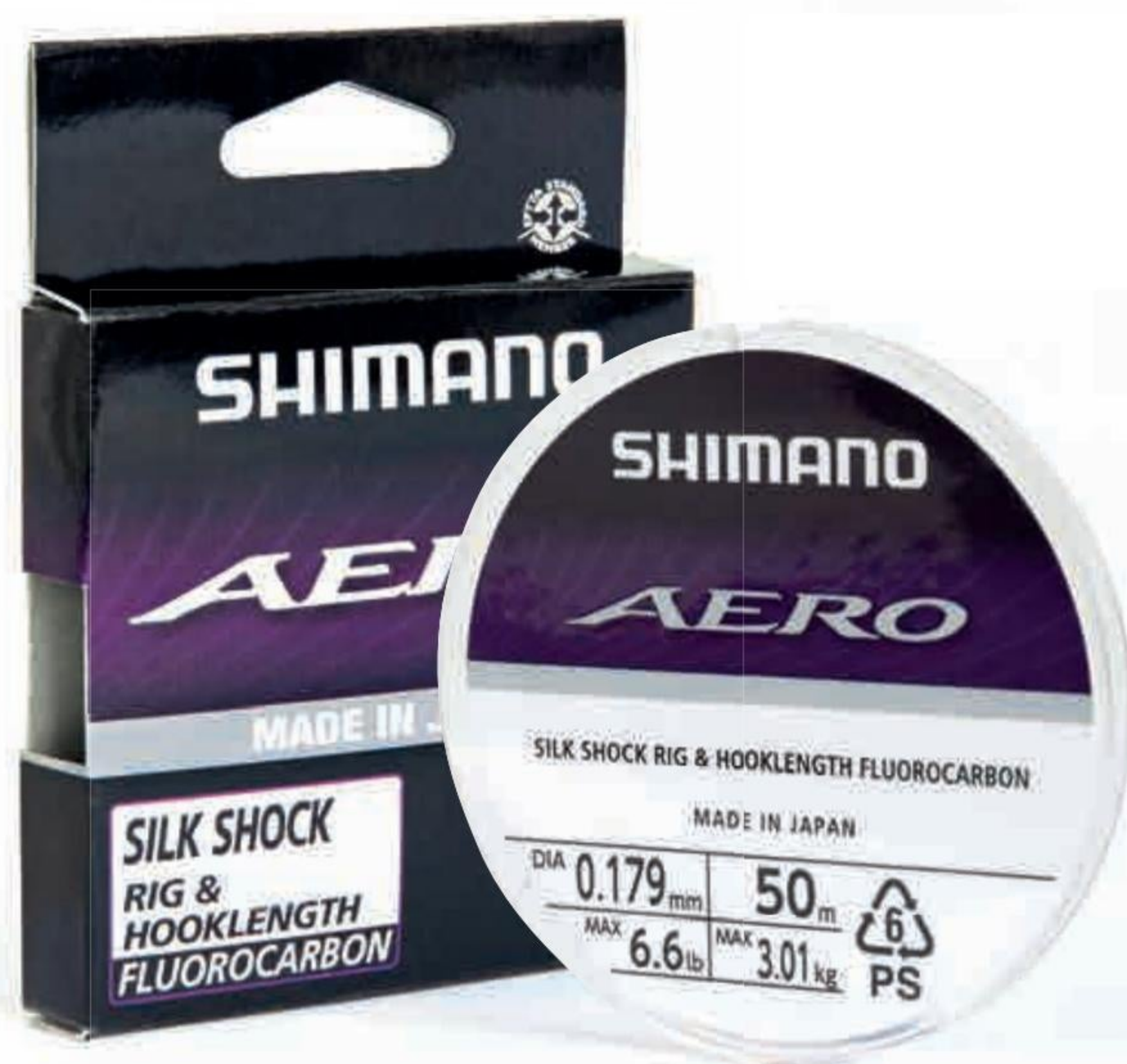

## AERO SILK SHOCK FLUOROCARBON

- 100% fluorocarbon pole rig and hooklength line
- Almost invisible under water for improved bait presentation
- Fast sinking with low memory for perfect pole float control
- One of the best feeder fishing hooklength materials available
- Exceptional knot strength and resilience to damage

	Spool	0.080mm 0.52kg	0.104mm 1.10kg	0.114mm 1.29kg	0.132mm 1.72kg	0.158mm 2.46kg
AERSSFRH50	50m	✓	✓	✓	✓	✓
	Spool	0.179mm 3.01kg	0.195mm 3.26kg	0.220mm 3.88kg	0.255mm 5.35kg	
AERSSFRH50	50m	✓	✓	✓	✓	



### **Trout** **COMPETITION** FLUOROCARBON

- 100% fluorocarbon leader for trout fishing
- Very robust and abrasion resistant to reduce damage from sharp teeth
- Low visibility under water to increase takes especially in clear water
- Soft and supple for good knotting and improved bait presentation
- Thin diameters for finesse presentation

	Spool	0.120mm 1.05kg	0.140mm 1.29kg	0.1665mm 2.05kg
TROUTCF50	50m	✓	✓	✓



### **Trout** **COMPETITION** MONO

- Designed for trout competition and commercial fishing
- Soft and supple characteristics for easy, accurate casting
- Low stretch for direct contact and faster striking
- Red colour for easy sighting on the surface but subdued colour under water
- Good linear and knot strength

	Spool	0.12mm 1.29kg	0.14mm 1.70kg	0.16mm 2.16kg	0.18mm 2.67kg	0.20mm 3.27kg	0.22mm 4.05kg
TROUTCM150	150m	✓	✓	✓	✓	✓	✓



### **YASEI** PREDATOR

- 100% fluorocarbon predator leader
- Very robust and extremely abrasion resistant
- Low visibility under water to increase takes especially in clear water
- Available in thin diameters for finesse and small lure fishing
- Soft and supple for good knotting and improved lure presentation

	Spool	0.90mm 40.19kg		0.100mm 45.86kg					
YASPF10	10m	✓		✓					
	Spool	0.18mm 2.93kg	0.20mm 3.05kg	0.22mm 3.59kg	0.25mm 5.06kg	0.28mm 6.32kg	0.30mm 7.17kg	0.35mm 8.08kg	0.40mm 11.93kg
YASPF150	50m	✓	✓	✓	✓	✓	✓	✓	✓

## CATANA SPINNING

- Versatile spinning mono
- Excellent value for money
- Low memory with good knot strength
- Japanese packaging style
- Made in Japan

Spool		0.16mm	0.18mm	0.20mm	0.22mm	0.25mm	0.28mm	0.30mm	0.35mm
CATSPG150	150m	2.90kg	3.50kg	4.20kg	5.40kg	6.70kg	8.20kg	9.20kg	12.50kg

## TECHNIUM TRIBAL

- A robust monofilament line with a camouflage finish
- Low stretch for increased bite detection
- High strength and suppleness
- Green camouflage finish is less detectable to wary fish
- An outstanding line for fishing weedy waters

Spool		0.28mm	0.30mm	0.35mm	0.40mm
TECTRQP	Q.Pound (Premium)	7.50kg	8.50kg	11.50kg	14.00kg
TECTRBLK5000	5000m	✓ (1250m)	✓ (1100m)	✓ (790m)	✓ (620m)

## TRIBAL FLUOROCARBON

- A very supple/ flexible line for excellent castability
- Very fast sinking
- Clear coloured for low visibility
- Excellent abrasion resistance
- Made in Japan

Spool		0.32mm	0.35mm
TRCFC1000	1000m	14 lbs	16 lbs
TRCFC250	250m	✓	✓



# SALTWATER MONO



## SpeedMaster

- Superior casting performance for distance and accuracy
- Low stretch transfers more power into the lead on the cast
- Extremely abrasion resistance, protecting the line against sharp obstructions underwater
- High breaking strength
- Clear colour

	Spool	0.18mm 3.05kg	0.20mm 3.69kg	0.22mm 4.38kg	0.25mm 5.54kg	0.28mm 6.81kg	0.30mm 7.95kg	0.35mm 10.21kg
SMSM	300m	✓	✓	✓	✓	✓	✓	✓
SMSM	1200m	✓	✓	✓	✓	✓	✓	✓



## SpeedMaster TAPERED SURF LEADER

- High abrasion resistance and high knot strength
- Highly visible colour
- Super smooth finish ensures precision casting at long distances
- 10 leaders each of 15 meter
- Good alternative for the Tapered Surf line

	Spool	0.18-0.50mm (2.20-12.00kg)	0.20-0.57mm (2.70-17.00kg)	0.23-0.57mm (3.60-17.00kg)	0.26-0.57mm (4.60-17.00kg)	0.33-0.57mm (7.20-17.00kg)
SMTLSF	10 x 15m Orange	✓	✓	✓	✓	✓
SMTLSF	10 x 15m Clear	✓	✓	✓	✓	✓



## SpeedMaster TAPERED SURF LINE

- No more knots needed when tying shock leaders
- Less knots generate less friction and improve casting
- Made in Japan

	Spool	0.235-0.57mm (3.50-16.70kg)	0.260-0.57mm (4.40-16.70kg)	0.330-0.57mm (6.90-16.70kg)
SMTSF220	220m	✓	✓	✓





## TIAGRA HYPER

- TIAGRA HYPER TROLLING meets IGFA rules, means it is suitable for usage in official tournaments
- Line with low memory for preventing knots
- Special colours which will be almost invisible in the ocean waters
- Incredible abrasion resistant, built to last during fast runs of a big fish
- Reasonable elongation to absorb shocks during the take and the fight
- Very high knot strength

	Spool	0.42mm 20lb / 10kg	0.52mm 30lb / 15kg	0.68mm 50lb / 24kg	0.86mm 80lb / 37kg
TGHP0	1000m	✓	✓	✓	✓



## TIAGRA TROLLING

- Line with low memory for preventing knots
- Special colours which will be almost invisible in the ocean waters
- Incredible abrasion resistant, built to last during fast runs of a big fish
- Reasonable elongation to absorb shocks during the take and the fight
- Very high knot strength
- Made in Japan

	Spool	0.45mm 20lb / 9kg	0.55mm 30lb / 13kg	0.70mm 50lb / 22.7kg	0.90mm 80lb / 36.3kg
TGRG0	1000m	✓	✓	✓	✓



NEW

## OCEA EX FLUORO LEADER

- High breaking strength compared to its diameter
- Clear coloured
- Refractive index is close to that of water, therefore nearly invisible for fish
- Soft Fluoro core for knot strength, hard outer shell for abrasion resistance, fluorine coating for smooth surface finish

	Spool	0.16mm 4lb	0.20mm 6lb	0.23mm 8lb	0.26mm 10lb	0.29mm 12lb	0.33mm 16lb	0.37mm 20lb	0.40mm 25lb
59WCL74FU	50m	✓ (12)	✓ (14)	✓ (16)	✓ (18)	✓ (1A)	✓ (1C)	✓ (1D)	✓ (1E)
	Spool	0.47mm 30lb	0.57mm 40lb	0.62mm 50lb	0.71mm 60lb	0.78mm 80lb	0.91mm 100lb	1.00mm 130lb (20m spool)	
59WCL74FU	50m	✓ (1G)	✓ (1J)	✓ (1K)	✓ (1M)	✓ (1P)	✓ (1T)	✓ (1V)	



## 怪力 KAIRIKI 8

- Advanced 8 carrier Japanese PE braid, manufactured with S-EBT (SHIMANO Enhanced Body Technology)
- Produces tighter, smoother and rounder line for longer casts
- Selecting newer and softer PE material gives a supple feeling that the pro demands
- Available in 4 colours: High visibility Mantis Green, Yellow, Multi Coloured and low visibility Steel Grey
- 150m, 300m and 3000m bulk spools are available in up to 12 different diameters, from  $\varnothing$  0,06mm to  $\varnothing$  0,42mm

Spool			0.06mm 5.3kg	0.10mm 6.5kg	0.13mm 8.2kg	0.16mm 10.3kg	0.19mm 12kg	0.20mm 17.1kg	0.215mm 20.8kg	0.23mm 22.5kg	0.28mm 29.3kg	0.315mm 33.5kg	0.35mm 39.5kg	0.42mm 46.7kg
59WPLA58R	150m	Mantis Green	✓(00)	✓(01)	✓(02)	✓(03)	✓(04)	✓(05)	✓(06)	✓(07)	✓(08)	✓(09)	✓(0A)	✓(0B)
		Steel Grey	✓(10)	✓(11)	✓(12)	✓(13)	✓(14)	✓(15)	✓(16)	✓(17)	✓(18)	✓(19)	✓(1A)	✓(1B)
		Yellow	✓(30)	✓(31)	✓(32)	✓(33)	✓(34)	✓(35)	✓(36)	✓(37)	✓(38)			
59WPLA68R	300m	Mantis Green	✓(00)	✓(01)	✓(02)	✓(03)	✓(04)	✓(05)	✓(06)	✓(07)	✓(08)	✓(09)	✓(0A)	✓(0B)
		Steel Grey	✓(10)	✓(11)	✓(12)	✓(13)	✓(14)	✓(15)	✓(16)	✓(17)	✓(18)			
		Yellow	✓(30)	✓(31)	✓(32)	✓(33)	✓(34)	✓(35)	✓(36)	✓(37)	✓(38)			
		Multi	✓(20)	✓(21)	✓(22)	✓(23)	✓(24)	✓(25)	✓(26)	✓(27)	✓(28)	✓(29)	✓(2A)	✓(12B)
59WPLM98S	3000m	Mantis Green	✓(18)	✓(1A)	✓(1B)	✓(1C)	✓(1D)	✓(1F)	✓(1G)	✓(1H)	✓(1J)	✓(1K)	✓(1L)	✓(1M)
		Steel Grey		✓(2A)	✓(2B)	✓(2C)	✓(2D)	✓(2F)	✓(2G)	✓(2H)	✓(2J)	✓(2K)	✓(2L)	
		Yellow	✓(48)	✓(3A)	✓(3B)	✓(3C)	✓(3D)	✓(3F)	✓(3G)	✓(3H)	✓(3J)	✓(3K)	✓(3L)	
		Multi		✓(4A)	✓(4B)	✓(4C)	✓(4D)		✓(4G)	✓(4H)	✓(4J)	✓(4K)	✓(4L)	✓(2M)



## 極力 KAIRIKI 4

- High quality Japanese 4 carrier braid at a very economical price (50% less than 8 strand braids)
- VT construction produces a tight weave, smooth finish for longer casts and less noise
- Reduced stretch factor of less than 3% for increased sensitivity
- Four colours available - Mantis Green, Steel Grey, Hi-Vis Orange and Multi Colour (base colour changes every 10m) to suit different techniques

Spool			0.06mm 4.4kg	0.10mm 6.8kg	0.13mm 7.4kg	0.16mm 8.1kg	0.19mm 11.6kg	0.20mm 13.8kg	0.215mm 16.7kg	0.23mm 18.6kg	0.28mm 26kg	0.315mm 29.9kg
LDM54TE	150m	Mantis Green (G)	✓ (06)	✓ (08)	✓ (10)	✓ (15)	✓ (18)	✓ (20)	✓ (25)	✓ (30)	✓ (40)	✓ (50)
		Steel Grey (S)	✓ (06)	✓ (08)	✓ (10)	✓ (15)	✓ (18)	✓ (20)	✓ (25)	✓ (30)	✓ (40)	✓ (50)
		Hi-vis Orange (H)	✓ (06)	✓ (08)	✓ (10)	✓ (15)	✓ (18)	✓ (20)	✓ (25)	✓ (30)	✓ (40)	✓ (50)
		Multi (M)	✓ (06)	✓ (08)	✓ (10)	✓ (15)	✓ (18)	✓ (20)	✓ (25)	✓ (30)	✓ (40)	✓ (50)
LDM64TE	300m	Mantis Green (G)	✓ (06)	✓ (08)	✓ (10)	✓ (15)	✓ (18)	✓ (20)	✓ (25)	✓ (30)	✓ (40)	✓ (50)
		Steel Grey (S)	✓ (06)	✓ (08)	✓ (10)	✓ (15)	✓ (18)	✓ (20)	✓ (25)	✓ (30)	✓ (40)	✓ (50)
		Hi-vis Orange (H)	✓ (06)	✓ (08)	✓ (10)	✓ (15)	✓ (18)	✓ (20)	✓ (25)	✓ (30)	✓ (40)	✓ (50)
		Multi (M)	✓ (06)	✓ (08)	✓ (10)	✓ (15)	✓ (18)	✓ (20)	✓ (25)	✓ (30)	✓ (40)	✓ (50)
LDM94TE	3000m	Mantis Green (G)	✓ (06)	✓ (08)	✓ (10)	✓ (15)	✓ (18)	✓ (20)	✓ (25)	✓ (30)	✓ (40)	✓ (50)
		Steel Grey (S)	✓ (06)	✓ (08)	✓ (10)	✓ (15)	✓ (18)	✓ (20)	✓ (25)	✓ (30)	✓ (40)	✓ (50)
		Hi-vis Orange (H)	✓ (06)	✓ (08)	✓ (10)	✓ (15)	✓ (18)	✓ (20)	✓ (25)	✓ (30)	✓ (40)	✓ (50)
		Multi (M)	✓ (06)	✓ (08)	✓ (10)	✓ (15)	✓ (18)	✓ (20)	✓ (25)	✓ (30)	✓ (40)	✓ (50)



NEW

## 極力 KAIRIKI G5

- Fast sinking braid for both freshwater and saltwater
- 4 carrier Japanese PE braid, with additional high density, heavier core
- Less effected by wind during the cast and current when sinking due to the increased weight, delivering quicker, more direct control to lures
- Maintains the same strength and minimal stretch as other Kairiki Braid
- Available in 2 colours: High visibility Orange and low visibility Steel Grey
- 100m, 150m and 200m spools
- 6 different diameters, from ø 0,13mm to ø 0,23mm

Spool			0.13mm 4.1kg	0.15mm 5.5kg	0.17mm 76.9kg	0.18mm 8.0kg	0.20mm 9.9kg	0.23mm 12.9kg
LDM41UE	100m	Steel Grey (S)	✓	✓		✓		
		Hi-Vis Orange(H)	✓	✓		✓		
LDM51UE	150m	Steel Grey (S)	✓	✓	✓	✓	✓	✓
		Hi-Vis Orange(H)	✓	✓	✓	✓	✓	✓
LDM61UE	200m	Steel Grey (S)	✓	✓	✓	✓	✓	✓
		Hi-Vis Orange(H)	✓	✓	✓	✓	✓	✓



**Excellent Line Management**

- Won't bury in the spool
- Picks up less water
- Spools up and packs better on any reel
- No reel memory

**Structurally Superior**

- Reduces wind knots, backlashes, guides and rod tip wrap overs
- Ties more easily and holds knots better
- Near zero stretch
- Unbelievable strength-to-diameter ratio

**Smoother and Slicker**

- Sails effortlessly through the guides for longer casts
- Resists abrasion by equipment or natural hazards
- Won't cut guides
- Maintains performance over time

Spool		0.06mm 3.00kg	0.08mm 4.00kg	0.10mm 5.00kg	0.13mm 8.00kg	0.15mm 9.00kg	0.19mm 13.00kg	0.23mm 15.00kg	0.28mm 20.00kg	0.32mm 24.00kg	0.36mm 30.00kg	0.41mm 40.00kg	0.43mm 48.00kg	0.46mm 55.00kg	0.56mm 75.00kg	0.76mm 95.00kg	
PPBI	135m	Moss Green (MG)	✓	✓	✓	✓	✓	✓	✓	✓	✓	✓	✓	✓	✓	✓	
		White (W)	✓	✓	✓	✓	✓	✓	✓	✓	✓	✓	✓	✓	✓	✓	✓
		Yellow (Y)	✓	✓	✓	✓	✓	✓	✓	✓	✓	✓	✓	✓	✓	✓	✓
		Red (R)	✓	✓	✓	✓	✓	✓	✓	✓	✓	✓	✓	✓	✓	✓	✓
	275m	Moss Green (MG)	✓	✓	✓	✓	✓	✓	✓	✓	✓	✓	✓	✓	✓	✓	✓
		White (W)			✓	✓	✓	✓	✓	✓	✓	✓	✓	✓	✓	✓	✓
		Yellow (Y)		✓	✓	✓	✓	✓	✓	✓	✓	✓	✓	✓	✓	✓	✓
		Red (R)			✓	✓	✓	✓	✓	✓	✓	✓	✓	✓	✓	✓	✓
	455m	Moss Green (MG)				✓	✓	✓	✓	✓	✓	✓	✓	✓	✓	✓	✓
		Yellow (Y)					✓	✓	✓	✓	✓	✓	✓	✓	✓	✓	✓
		Red (R)					✓	✓	✓	✓	✓	✓	✓	✓	✓	✓	✓
	1370m	Moss Green (MG)			✓	✓	✓	✓	✓	✓	✓	✓	✓	✓	✓	✓	✓
		Yellow (Y)			✓	✓	✓	✓	✓	✓	✓	✓	✓	✓	✓	✓	✓
		Red (R)			✓	✓	✓	✓	✓	✓	✓	✓	✓	✓	✓	✓	✓
	2740m	Moss Green (MG)			✓	✓	✓	✓	✓	✓	✓	✓	✓	✓	✓	✓	✓
		White (W)			✓	✓	✓	✓	✓	✓	✓	✓	✓	✓	✓	✓	✓
		Yellow (Y)			✓	✓	✓	✓	✓	✓	✓	✓	✓	✓	✓	✓	✓
		Red (R)			✓	✓	✓	✓	✓	✓	✓	✓	✓	✓	✓	✓	✓



**POWER PRO Super & Slick V2**

- 8 braid construction with proven EBT technology
- Available in moss green, Hi-Visual aqua green and moon shine
- Strong yet smooth and soft

Spool		0.13mm 8kg	0.15mm 10kg	0.19mm 15kg	0.23mm 17kg	0.28mm 20kg	0.32mm 24kg	0.36mm 30kg	0.41mm 40kg	0.43mm 50kg
135m	Moss	✓	✓	✓	✓	✓	✓			
	Aqua	✓	✓	✓	✓	✓	✓			
	Moon	✓	✓	✓	✓	✓	✓			
275m	Moss	✓	✓	✓	✓	✓	✓	✓	✓	
	Aqua	✓	✓	✓	✓	✓	✓	✓	✓	
	Moon	✓	✓	✓	✓	✓	✓	✓	✓	
2740m	Moss	✓	✓	✓	✓	✓	✓	✓	✓	✓
	Aqua	✓	✓	✓	✓	✓	✓	✓	✓	✓
	Moon	✓	✓	✓	✓	✓	✓	✓	✓	✓

Colour Codes: Moss Green (MG), Aqua Green (AG), Moon Shine (MS)



## POWER PRO DEPTH HUNTER

- Japanese engineered multi-coloured braided line
- Different colour bands at 10m intervals for optimized depth and distance control
- Perfect for trolling, vertical jigging and deep sea fishing applications
- Excellent line management

	Spool	0.13mm	0.15mm	0.19mm	0.23mm	0.28mm	0.32mm	0.36mm	0.41mm
		8.00kg	9.00kg	13.00kg	15.00kg	20.00kg	24.00kg	30.00kg	40.00kg
PPBI	300m		✓	✓	✓	✓	✓	✓	
	1600m	✓	✓	✓	✓	✓	✓	✓	✓

## ORDERING MONO LINE AND BRAID

Below is a guide on how to order the different spool lengths and sizes of each SHIMANO line and POWERPRO braid...

LINE	CODE	LINE EXAMPLE	TO ORDER: STATE...	ORDER CODE EXAMPLE
TECHNIUM	TEC	200m spool, 0.16mm diameter	Code followed by Spool Length and then Diameter	TEC20016
TECHNIUM PREMIUM BOX	TEC (PB)	300m spool, 0.22mm diameter	Code followed by Spool Length, Diameter and then PB	TEC30022PB
TECHNIUM QUARTER POUND PREMIUM BOX	TEC (QPPB)	2990m spool, 0.18mm diameter	Code followed by Diameter and then QPPB	TEC18QPPB
TECHNIUM BULK	TEC (BLK)	5000m spool, 0.25mm diameter	Code followed by Diameter, BLK and then Spool Length	TEC25BLK5000
TECHNIUM INVISITEC	TECINV	300m spool, 0.16mm diameter	Code followed by Spool Length and then Diameter	TECINV30016
TECHNIUM INVISITEC QUARTER POUND	TECINV (QPPB)	2990m spool, 0.18mm diameter	Code followed by Diameter and then QPPB	TECINV18QPPB
TECHNIUM INVISITEC BULK	TECINV (BLK)	5000m spool, 0.25mm diameter	Code followed by Diameter, BLK and then Spool Length	TECINV25BLK5000
EXAGE	EXG	150m spool, 0.12mm diameter	Code followed by Spool Length and then Diameter	EXG15012
AERO FLOAT	AERFL	150m spool, 0.137mm diameter	Code followed by Spool Length and then Diameter	AERFL150137
AERO SLICK SILK	AERSSRH	100m spool, 0.076mm diameter	Code followed by Spool Length and then Diameter	AERSSRH100076
AERO SLICK SHOCK FLUORO	AERSSFRH	50m spool, 0.080mm diameter	Code followed by Spool Length and then Diameter	AERSSFRH50080
TROUT COMPETITION FLUORO	TROUTCF	50m spool, 0.12mm diameter	Code followed by Spool Length and then Diameter	TROUTCF5012
TROUT COMPETITION	TROUTCM	150m spool, 0.12mm diameter	Code followed by Spool Length and then Diameter	TROUTCM15012
YASEI FLUORO	YASPFL	50m spool, 0.18mm diameter	Code followed by Spool Length and then Diameter	YASPFL5018
CATANA SPINNING	CATSPG	150m spool, 0.16mm diameter	Code followed by Spool Length and then Diameter	CATSPG15016
TECHNIUM TRIBAL Q.POUND PREMIUM BOX	TECTR (QPPB)	1250m spool, 0.28mm diameter	Code followed by Diameter and then QPPB	TECTR28QPPB
TECHNIUM TRIBAL BULK	TECTR (BLK)	5000m spool, 0.30mm diameter	Code followed by Diameter, BLK and then Spool Length	TECTR30BLK5000
TRIBAL CARP FLUORO	TRCFC250()	250m spool, 0.32mm diameter	Code followed by Spool Length and then Number in bracket	TRCFC25014
SPEEDMASTER SURF	SMSM	300m spool, 0.18mm diameter	Code followed by Diameter and then Spool Length	SMSM18300
SPEEDMASTER TAPERED LEADER ORANGE	SMTLSF	10x15m spool, 0.18-0.50mm diameter	Code followed by Diameter	SMTLSF1850
SPEEDMASTER TAPERED LEADER CLEAR	SMTLSF (C)	10x15m spool, 0.18-0.50mm diameter	Code followed by Diameter and then C	SMTLSF1850C
SPEEDMASTER TAPERED	SMTSF	220m spool, 0.23-0.57mm diameter	Code followed by Spool Length and then Diameter	SMTSF2202357
TIAGRA HYPER TROLL CLEAR BLUE	TGHP0 (CB)	1000m spool, 20lb	Code followed by Strength, Spool Length and then CB	TGHP0201000CB
TIAGRA TROLLING CLEAR PINK	TGRG0 (CP)	1000m spool, 20lb	Code followed by Strength, Spool Length and then CP	TGRG0201000CP
OCEA EX FLUORO LEADER	59WCL74FU()	50m spool, 4lb	Code followed by Number in bracket	59WCL74FU12
KAIRKI 8 150m	59WPLA58R()	150m spool, 0.06mm diameter, green	Code followed by Number in bracket	59WPLA58R00
KAIRKI 8 300m	59WPLA68R()	300m spool, 0.06mm diameter, green	Code followed by Number in bracket	59WPLA68R00
KAIRKI 8 3000m	59WPLM98S()	3000m spool, 0.10mm diameter, green	Code followed by Number in bracket	59WPLM98S1A
KAIRKI 4	LDM54TE	150m spool, 0.06mm diameter, green	Code followed by Number in bracket, Diameter, Spool Length and then Colour Code	LDM54TE0606015G
KAIRKI G5	LDM41UE	100m spool, 0.13mm diameter, steel gray	Code followed by Diameter, Spool Length and then Colour Code	LDM41UE130100S
POWERPRO	PPBI	135m spool, 0.06mm diameter, moss green	Code followed by Spool Length, Diameter and then Colour Code	PPBI13506MG
POWERPRO V2	PPBISV2	135m spool, 0.13mm diameter, moon shine	Code followed by Spool Length, Diameter and then Colour Code	PPBISV213513MS
POWERPRO DEPTH HUNTER	PPBI (MJ)	135m spool, 0.15mm diameter	Code followed by Spool Length, Diameter and then MJ	PPBI30015MJ



# CLOTHING

Outer clothing, caps, eye protection and other clothing accessories complete a truly impressive range of advanced, modern apparel for the advanced angler.





**CLOTHING**

288	TACTICAL GEAR CLOTHING RANGE	
289	TRENCH GEAR CLOTHING RANGE	
290	WADERS	
291	DRYSHIELD CLOTHING	<b>NEW</b>
292	GORE-TEX CLOTHING	<b>NEW</b>
293	DURAST CLOTHING	<b>NEW</b>
	CAPS	<b>NEW</b>
294	HATS	<b>NEW</b>
	GLOVES	<b>NEW</b>

**SUNGLASSES**

295	SUNGLASSES
-----	------------



# TACTICAL GEAR / TRENCH GEAR CLOTHING



## FLEECE LINED PULLOVER

- SHIMANO Tactical Gear branded fleece lined pullover with high neck fastening and adjustable velcro sleeves
- Shell: 100% Nylon, Lining: 260gsm Sherpa
- Available in: M / L / XL / 2XL / 3XL

• **CODE:** SHTTW02



## HOODIE

- SHIMANO Tactical Gear branded hoodie with draw string neck and full frontal pocket
- 65% Polyester, 35% Cotton - 280gsm
- Available in: M / L / XL / 2XL / 3XL

• **CODE:** SHTTW06



## JOGGERS

- SHIMANO Tactical Gear branded joggers with drawstring waistband
- 65% Polyester, 35% Cotton - 280gsm
- Available in: M / L / XL / 2XL / 3XL

• **CODE:** SHTTW09



## ZIP-OFF COMBAT TROUSERS

- SHIMANO Tactical Gear branded Ripstop zip-off combat trousers with large leg pockets
- Instantly converts to knee length shorts
- 100% Cotton
- Available in: M / L / XL / 2XL / 3XL

• **CODE:** SHTTW12



## CARGO TROUSERS

- SHIMANO Tactical Gear branded cargo trousers with drawstring cuffs at the bottom and two large leg pockets
- Shell: 100% Nylon, Lining: 260gsm Sherpa
- Available in: M / L / XL / 2XL / 3XL

• **CODE:** SHTTW13





TACTICAL GEAR

### BLACK T-SHIRT

- SHIMANO Tactical Gear branded black t-shirt with large SHIMANO TRIBAL logo on the front
- 100% Cotton
- Available in: M / L / XL / 2XL / 3XL

• CODE: SHTTW15



TACTICAL GEAR

### TAN T-SHIRT

- SHIMANO Tactical Gear branded tan t-shirt with large SHIMANO TRIBAL logo on the front
- 100% Cotton
- Available in: M / L / XL / 2XL / 3XL

• CODE: SHTTW16



TACTICAL GEAR

### POLO SHIRT

- SHIMANO Tactical Gear branded polo shirt with SHIMANO TRIBAL logo on shoulder sleeve
- 100% Cotton
- Available in: M / L / XL / 2XL / 3XL

• CODE: SHTTW17

## TRENCH GEAR



TRENCH GEAR

### TRICAM T-SHIRT

- SHIMANO Trench Gear branded t-shirt with SHIMANO TRIBAL logo on shoulder
- 100% Cotton
- Available in: M / L / XL / 2XL / 3XL

• CODE: SHTTW14



TRENCH GEAR

### ZIPPED TRICAM HOODIE

- SHIMANO Trench Gear branded hoodie with full zip and drawstring hood
- 65% Polyester, 35% Cotton
- Available in: M / L / XL / 2XL / 3XL

• CODE: SHTTW05



TRENCH GEAR

### HEAVY TRICAM JOGGERS

- SHIMANO Trench Gear branded joggers with drawstring waistband and elasticated cuffs at the bottom
- 65% Polyester, 35% Cotton - 320gsm
- Available in: M / L / XL / 2XL / 3XL

• CODE: SHTTW08



## PVC CHEST WADERS

- Waterproof PVC chest waders
- High wear durability
- Adjustable webbing braces with quick release plastic buckles (chest waders)
- Extra wide welded seams
- PVC boot with cleated sole
- Includes repair kit

SHPVCW

Sizes: 40 / 41 / 42 / 43 / 44 / 45 / 46 / 47

## PVC THIGH WADERS

- Waterproof PVC thigh waders
- High wear durability
- Extra wide welded seams
- PVC boot with cleated sole
- Includes repair kit

SHPVCTHB

Sizes: 40 / 41 / 42 / 43 / 44 / 45 / 46 / 47





**NEW**

## DRYSHIELD BASIC SUIT

- Jacket and pants combination
- Constructed from waterproof and breathable Dryshield 2L fabric, to maximize comfort in both wet and dry conditions
- Additional space in the shoulder and chest area for improved movement when fishing
- Adjustable tab double cuffs and a drawstring hood and hem to ensure a weatherproof fit
- Available in Pure Black and Blue with Charcoal Gray pants
- Outer: 100% Polyamide (breathable waterproofing)  
Lining (Mesh): 100% Polyester
- Blue available in: XS / S / M / L / XL / 2XL
- Black available in: XS / S / M / L / XL / 2XL / 3XL

Code	Colour	Size						
		XS	S	M	L	XL	2XL	3XL
59YRA027QL	Blue	59YRA027QL2	59YRA027QL3	59YRA027QL5	59YRA027QL8	59YRA027QL9	59YRA027QLA	-
59YRA027QK	Black	59YRA027QK2	59YRA027QK3	59YRA027QK5	59YRA027QK8	59YRA027QK9	59YRA027QKA	59YRA027QKB



**NEW**

## ACTIVE INSULATION PANTS

- Designed with thick insulation for additional warmth
- Perfect middle layer when worn under outer garments in cold weather, or as an outer layer in dry and less cold conditions
- Fitted with front zipper, two pockets and a special hem design
- Perfect companion for chest waders in colder conditions
- Available in Black and Tungsten
- Outer & Lining: 88% Polyamide, 12% Elastane (waterproofing) Padding: 100% Polyester
- Black available in: XS / S / M / L / XL / 2XL
- Tungsten available in: XS / S / M / L / XL



Code	Colour	Size					
		XS	S	M	L	XL	2XL
59YWP066U	Tungsten	59YWP066U22	59YWP066U23	59YWP066U25	59YWP066U28	59YWP066U29	-
59YWP066U	Black	59YWP066U12	59YWP066U13	59YWP066U15	59YWP066U18	59YWP066U19	59YWP066U1A

# GORE-TEX CLOTHING / CAPS



**NEW**

## GORE-TEX® WARM RAIN PANTS

- Perfect partner for the Gore-Tex® Warm Rain Jacket
- Totally waterproof and breathable, even in the most extreme conditions
- 3D design increases the range of movement available
- Lightweight fabric with heat-storage lining, ensures maximum comfort
- Removable suspenders
- Available in Black: XS / S / M / L / XL / 2XL
- Outer: 100% Polyester (breathable waterproofing)  
Filling: 100% Polyester  
Back: 100% Nylon

		Size		
XS	S	M		
59YRB01PU12	59YRB01PU13	59YRB01PU15		
		Size		
L	XL	2XL		
59YRB01PU18	59YRB01PU19	59YRB01PU1A		



**NEW**

## GORE-TEX® INFINIUM OPTIMAL JACKET

- Made from Gore-Tex® Infinium
- Premium windstopper fabric that is highly durable, water resistant and breathable
- Ideal as an 'everyday' garment
- Wear inserts on the elbows, sides and shoulders, to extend longevity
- Close fitting neoprene cuffs for added protection from draughts
- Available in Charcoal
- Outer: 100% Polyester (breathable windproofing)  
Part: 86% Polyester / 14% Elastane
- Available in: XS/ S / M / L / XL

		Size				
Code	Colour	XS	S	M	L	XL
59YWJ090U	Charcoal	59YWJ090U32	59YWJ090U33	59YWJ090U35	59YWJ090U38	59YWJ090U39



**NEW**

## GORE-TEX® WARM RAIN JACKET

- Premium quality lightweight jacket for the very best protection
- Manufactured from waterproof and breathable Gore-Tex® fabric
- Features a slim silhouette 3D design with the SHIMANO Up Swing Pattern for increased arm movement above the head
- Stretch double cuffs, drawstring hood and hem
- V-shaped tension hood adjuster and water-stop fasteners
- Available in Black and Blue
- Outer: 100% Polyester (breathable waterproofing)  
Padding: 100% Polyester  
Lining: 100% Polyamide
- Blue available in: S / M / L / XL
- Black available in: XS / S / M / L / XL / 2XL

		Size					
Code	Colour	XS	S	M	L	XL	2XL
59YRB01JU	Blue	-	59YRB01JU33	59YRB01JU35	59YRB01JU38	59YRB01JU39	-
59YRB01JU	Black	59YRB01JU12	59YRB01JU13	59YRB01JU15	59YRB01JU18	59YRB01JU19	59YRB01JU1A



**NEW**

## DURAST WARM SHORT RAIN JACKET

- Designed for maximum movement when wading
- Suitable for all types of mobile fishing
- Waterproof, breathable fabric resistant to rubbing on pressure points
- Heat saving lining for warmth
- Chloroprene double cuffs for protection from water and cold air
- V-shaped tension hood adjuster
- Available in Black and Beige: S / M / L / XL
- 100% Polyamide (breathable waterproofing)  
Padding: 100% Polyester  
Lining: 100% Polamide



Code	Colour	Size			
		S	M	L	XL
59YRB04SU	Beige	59YRB04SU23	59YRB04SU25	59YRB04SU28	59YRB04SU29
59YRB04SU	Black	59YRB04SU13	59YRB04SU15	59YRB04SU18	59YRB04SU19

**NEW**

## SHIMANO STANDARD CAP

- Simple, easy to wear cap
- Embroidered SHIMANO logo
- Velcro adjustable strap
- Available in Black, Khaki, Cool Grey and Cool Navy
- 100% Polyester

Colour			
Cool Navy	Cool Grey	Black	Khaki
59YCA041RHD	59YCA041RGD	59YCA041R1F	59YCA041R3F

**NEW**

## SHIMANO BASIC CAP

- Popular style cap
- 3D embroidered SHIMANO logo
- Velcro adjustable strap
- Available in Black, Dark Grey and Royal Blue
- 100% Polyester

Colour		
Royal Blue	Dark Grey	Black
59YCA061T6D	59YCA061T4D	59YCA061T1D

**NEW**

## SHIMANO FLAT CAP

- Wide brim cap
- 3D embroidered SHIMANO logo
- American hook strap
- Available in Black, Light Grey, and Navy Blue
- 100% Polyester

Colour		
Light Grey	Black	Navy Blue
59YCA066T8D	59YCA066T1D	59YCA066T2D

# HATS / GLOVES / SUNGLASSES



NEW

## BREATH HYPER + °C BEANIE

- Extremely warm
- 'Beanie' style knitted hat
- Made with Breath Hyper + °C material for maximum heat retention
- Available in Black and Steel Grey
- 100% Acrylic / Inner: Polyester 69%, Acrylate-fabric 27%, Polyurethane 4%

Colour	
Steel Grey	Black
59YCA064U2D	59YCA064U1D



NEW

## PEARL FIT GLOVES 3 FINGERS CUT

- Soft, easy to wear gloves
- Thumb and two fingers free for ease of use in cold conditions
- Made from stretch fabric
- Long length design increases warmth
- Adjustable cuff prevents water penetration via the wrist and ensures a secure fit
- Available in Black, Grey and Blue
- Outer: (print) 100% Polyester, (plain) 100% Nylon  
Palm: Artificial leather  
Inner: 100% Chloroprene Synthesis

Code	Colour	Size				
		XS	S	M	L	XL
59YGL091Q	Grey	-	59YGL091QH2	59YGL091QH3	59YGL091QH5	59YGL091QH8
59YGL091Q	Blue	59YGL091Q11	-	59YGL091QJ3	59YGL091QJ5	59YGL091QJ8
59YGL091Q	Black	-	59YGL091Q13	59YGL091Q14	59YGL091Q16	59YGL091Q19



NEW

## WINDPROOF BEANIE

- Low gauge knit watch 'beanie' style hat
- Windproof lining for additional warmth
- Available in Black and Steel Grey
- Outer: 100% Acrylic

Colour	
Steel Grey	Black
59YCA074U2D	59YCA074U1D



NEW

## PEARL FIT GLOVES 5 FINGERS CUT

- Soft, easy to wear fingerless gloves
- Made from stretch fabric
- Adjustable cuff prevents water penetration via the wrist and ensures a secure fit
- Long length design increases warmth
- Available in Black, Grey and Blue
- Outer: (print) 100% Polyester, (plain) 100% Nylon  
Palm: Artificial leather  
Inner: 100% Chloroprene Synthesis

Code	Colour	Size				
		XS	S	M	L	XL
59YGL092QJ	Blue	-	-	59YGL092QJ3	59YGL092QJ5	59YGL092QJ8
59YGL092QJ	Grey	-	-	59YGL092QH3	59YGL092QH5	59YGL092QH8
59YGL092QJ	Black	59YGL092Q11	59YGL092Q13	59YGL092Q14	59YGL092Q16	59YGL092Q19



NEW

## WATERPROOF GLOVES

- SHIMANO waterproof Gloves made from a totally waterproof material
- Sealed seams, for protection and warmth in cold conditions
- Features reinforced sections for casting protection and improved durability
- Outer: 50% Polyester, 32% Nylon, 18% Polyurethane  
Inner: 100% Polyester / Palm: Artificial leather

Black			
S	M	L	XL
59YGL085U12	59YGL085U13	59YGL085U15	59YGL085U18



NEW

## OCEA CHLOROPRENE GLOVES

- Designed for off-shore fishing
- Palms and finger sections for casting protection and improved durability
- Chloroprene fabric improves comfort and provides additional warmth
- Available in Black, Navy Blue and Tungsten
- Outer: 100% Nylon / Palm: Artificial leather  
Inner: 100% Chloroprene Synthesis

Code	Colour	Size			
		M	L	XL	2XL
59YGL295S	Navy Blue	59YGL295S43	59YGL295S45	59YGL295S48	-
59YGL295S	Tungsten	59YGL295S33	59YGL295S35	59YGL295S38	-
59YGL295S	Black	59YGL295S13	59YGL295S15	59YGL295S18	59YGL295S19



### BIOMASTER

- Polarized photo chromic lenses
- Silver Grilamid® TR90 Frame

• **CODE:** SUNBIO



### CATANA BX

- Grilamid® TR90 frame
- Rubberized nose pads

• **CODE:** SUNCATBX



### FORCEMASTER XT

- Polarized photo chromic lenses
- Silver Grilamid® TR90 Frame

• **CODE:** SUNFMXT



### SPEEDMASTER

- Grilamid® TR90 floating frame
- Rubberized nose pads

• **CODE:** SUNSP02



### FIREBLOOD

- Grilamid® TR90 Frame
- High contrast polarized lenses

• **CODE:** SUNFB



### PURIST

- Floating Grilamid® TR90 Frame
- Ventilation openings

• **CODE:** SUNPUR02



### AERNOS

- Shiny Black/Red Grilamid® TR90 frame
- Coloured polarised 0.65mm TAC lenses

• **CODE:** SUNAERNOS



### TECHNIUM

- 3D Carbon look Grilamid® TR90 frame
- Coloured polarised 1.0mm TAC mirrored lenses

• **CODE:** SUNTEC



### CURADO

- Black Grilamid® TR90 frame
- Yellow coloured polarised 1.0mm TAC lenses

• **CODE:** SUNC



### ASPIRE

- Smoke coloured polarised TAC lenses for a wide variety of conditions
- 3D Carbon look frame

• **CODE:** SUNASP



### BEASTMASTER

- Removable soft foam gasket for excellent protection
- Shiny black frame with yellow rubber inlay

• **CODE:** SUNBM02



### STRADIC

- Lens adjustment system to help improve visibility during changeable light situations
- Shiny peel white frame

• **CODE:** SUNSTR



### AERO

- Aero sunglasses feature two changeable grey & yellow coloured polarised lenses
- Shiny black frame

• **CODE:** SUNAER2



### TIAGRA 2

- Blue mirrored polarised polycarbonate lenses for saltwater use
- Shiny dark navy frame

• **CODE:** SUNTIA2



### YASEI

- Lightweight matte black Grilamid® TR90 frame

• **CODE:** SUNYASSM  
• **CODE:** SUNYASGR



## FISHING LURES

SHIMANO's JDM lures have an enviable world-wide reputation for quality, innovation and effectiveness. The exclusive SHIMANO technologies incorporated in the designs include FLASH BOOST foil mirrors for constant flashing action, JET BOOST System for improved casting distance, SCALE BOOST scale patterns for remarkable life-like reality, and Jerk Assist Balancer System for increased stability.





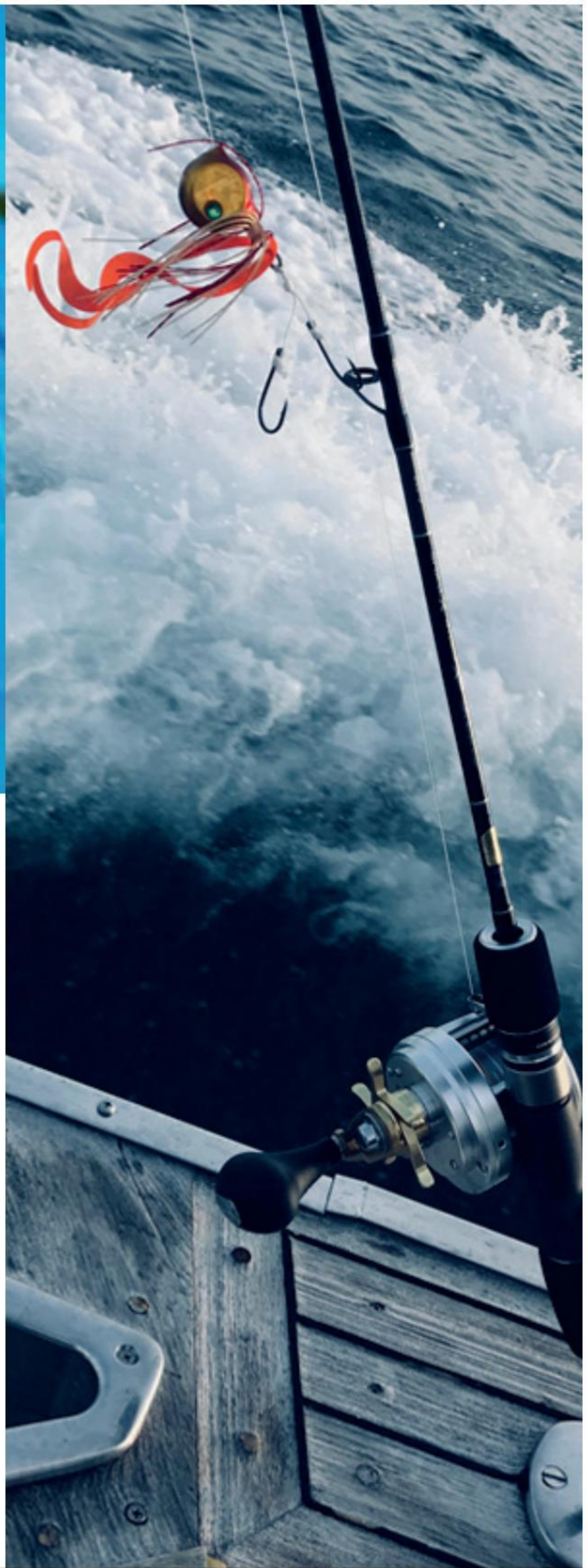

#### FRESHWATER LURES

- 298 LURE TECHNOLOGY
- 299 BANTAM LURES DEPTH CHART
- 300 BANTAM LURES
- 305 CARDIFF LURES DEPTH CHART
- 306 CARDIFF LURES
- 310 CARDIFF SPOONS

#### SALTWATER LURES

- 312 EXSENCE LURES DEPTH CHART
- 313 EXSENCE LURES
- 317 ENGETSU LURES
- 318 SOARE LURES
- 319 OCEA LURES
- 322 SEPHIA LURES



# LURE TECHNOLOGY

## BOOZ CONCEPT

### FLASH BOOST

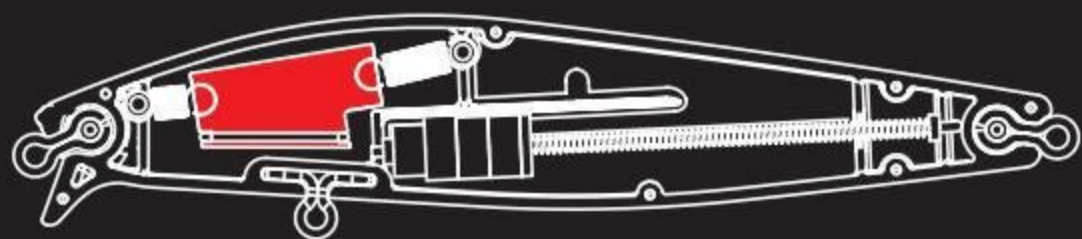

### FLASH BOOST

FLASH BOOST technology suspends a foil mirror, on small sensitive springs, inside of the lures body. This area of the body is translucent, enabling flashes to be seen when the lure wobbles.

### JET BOOST

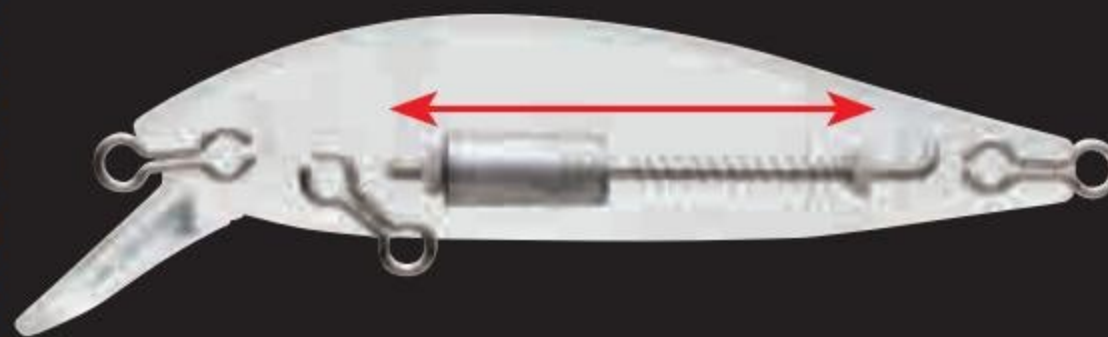

### JET BOOST

This design increases casting distance when compared to lures of similar weights and dimensions. The system uses an internal moving weight, controlled by a spring-type centre of gravity control (Pat.P) system. During the cast, the weight is forced towards the back of the lure, which creates a 'weight-forward' balance, improving casting distance and accuracy. Once in the water, the spring automatically returns the weight to the correct central position for maximum swimming performance.

### SCALE BOOST



### SCALE BOOST

This three dimensional holographic film offers remarkable life-like reality. Following as closely as possible the scale pattern and colours of the fish it replicates, in terms of size, shape and overlap, to increase attractiveness.

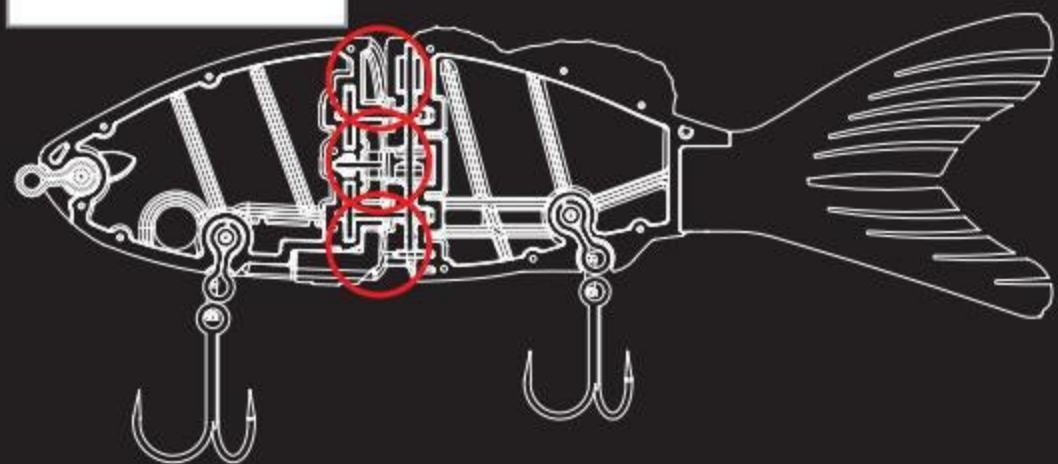

### TRIPLE JOINT SYSTEM

Triple Joint Technology is a three hinged construction combined with an asymmetric tail design. These features combine to produce a very realistic swimming action whatever the retrieve adopted.



### JERK ASSIST BALANCER SYSTEM

The Jerk Assist Balancer System increases stability when the lure is being retrieved at high speed, but allows for a darting action when the lure is twitched and jerked.



### MAGNETIC WEIGHT TRANSFER

The Magnet Weight Transfer system uses a metal ball weight within the body of the lure. When casting the ball is forced to the back of the lure for better balance in flight. With a slow retrieve the ball weight locks in the middle of the lure for improved life-like swimming action.



### CENTRE BALANCE SYSTEM

Centre Balance System creates a sliding action when moved, followed by a rolling action when stopped, which copies a last gasp move of a dying baitfish, trying to make an escape.



### 3X BODY

A combination of materials, plus a reinforced design, which produces higher impact resistance and up to three times the strength of standard lure construction.



### THROUGH WIRE

Through Wire construction connects the front line connection ring to all hook anchor points in the lure for failsafe lure performance.

# DEPTH CHART



## Bantam FRESHWATER LURES

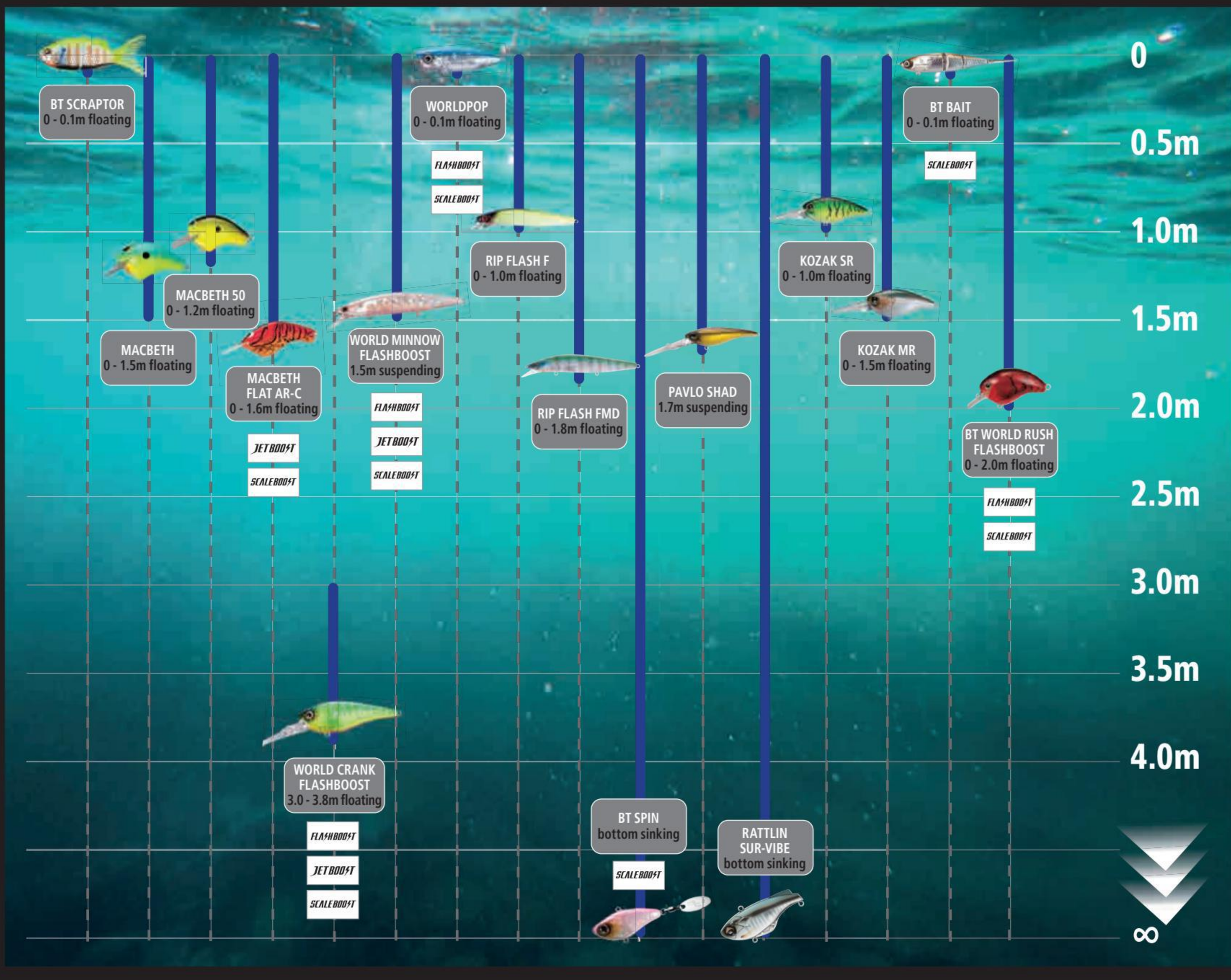

# BANTAM FRESHWATER LURES



## Bantam *Bt Sraaptor*

- Escape swimming action with asymmetric tail design
- S-Line action
- Triple joint system
- Special sinker holder for buoyancy adjustment
- Works with constant and jerk/twitch retrieves
- Floating (can be adjusted to sink)



Asymmetric tail design



001 Chart Gill

002 Manabuna

003 Yellowbait

004 KG Red

006 Bait Gill

					001	002	003	004	006
59VZR818T	58.0g	182mm	0.1m	Floating	59VZR818T00	59VZR818T01	59VZR818T02	59VZR818T03	59VZR818T04

NEW

## Bantam *Bt Bait*

- 3 sectioned micro hardbait with additional soft tail
- Natural swimming action with increased vibration from soft tail
- SCALE BOOST 3D holographic film for remarkable life-like scale reality
- Perfect for predators fixated on shoals of small bait fish
- Separate replacement tails available



SCALE BOOST



001 Wakasagi

002 White

003 Gizer

004 Pink H

005 Large Bass

006 Small Bass

007 Shart White

008 Sight Pink

009 Smelt

010 Ayu

					001	002	003	004	005	006	007	008	009	010
59VZR577V	5.0g	77mm	0-0.1m	Floating	59VZR577V00	59VZR577V01	59VZR577V02	59VZR577V03	59VZR577V04	59VZR577V05	59VZR577V06	59VZR577V07	59VZR577V08	59VZR577V09
					001	002	003	004	005	006	007	008	009	010
59VZR699V	6.0g	99mm	0-0.1m	Floating	59VZR699V00	59VZR699V01	59VZR699V02	59VZR699V03	59VZR699V04	59VZR699V05	59VZR699V06	59VZR699V07	59VZR699V08	59VZR699V09

# Bantam Macbeth

- Aggressive, wide kicking and rolling 'head-down' action
- Large square bill with rounded front corners
- Unique lower centre of gravity reduces snagging
- Quick start-up action on retrieve
- Works with constant and stop/start retrieves
- Floating - diving depth 1.5m



59VZP106T	16.0g	63mm	0-1.5m	Floating	001	002	003	004	005	006	007	008	009	010
					59VZP106T00	59VZP106T01	59VZP106T02	59VZP106T03	59VZP106T04	59VZP106T05	59VZP106T06	59VZP106T07	59VZP106T08	59VZP106T09

# Bantam Macbeth 50

- Small compact version of the original Bantam Macbeth
- Aggressive, wide kicking and rolling 'head-down' action
- Large square bill with rounded front corners
- Unique lower centre of gravity reduces snagging
- Works with constant and stop/start retrieves
- Floating - diving depth 1.2m



59VZP105T	12.0g	50mm	0-1.2m	Floating	001	002	003	004	005	006	007	008	009	010
					59VZP105T00	59VZP105T01	59VZP105T02	59VZP105T03	59VZP105T04	59VZP105T05	59VZP105T06	59VZP105T07	59VZP105T08	59VZP105T09

# Bantam Macbeth Flat

- Aggressive, wide kicking and rolling 'head-down' action
- Quick start-up action on retrieve
- Works with smooth, constant retrieves and stop/start jerks
- Floating – diving depth 1,6m
- JET BOOST concept for increased casting distance
- SCALE BOOST, 3D holographic film for remarkable life-like scale reality
- Flat body with wide, rounded lip to achieve a strong wobbling action. The lip shape also reduces snagging on underwater cover



59VZQC57S	9.0g	57mm	0-1.6m	Floating	001	002	003	004	005	006	007	008	009	010
					59VZQC57S00	59VZQC57S01	59VZQC57S02	59VZQC57S03	59VZQC57S04	59VZQC57S05	59VZQC57S06	59VZQC57S07	59VZQC57S08	59VZQC57S09

# BANTAM FRESHWATER LURES

## Bantam WorldCrank 73F FLASHBOOST

- Smooth and aggressive enticing swimming action
- Quick start-up action on retrieve
- Works with smooth, constant retrieves and pauses
- Floating – diving depth 3.0 – 3.8m
- FLASH BOOST technology allows the lure to constantly emit an attractive flash, even when stationary
- JET BOOST concept for increased casting distance
- SCALE BOOST, 3D holographic film for remarkable life-like scale reality



FLASHBOOST JETBOOST SCALEBOOST



59VZQC73U	17.0g	73mm	3.0-3.8m	Floating	001	002	003	004	005	006	007	008	009	010
					59VZQC73U00	59VZQC73U01	59VZQC73U02	59VZQC73U03	59VZQC73U04	59VZQC73U05	59VZQC73U06	59VZQC73U07	59VZQC73U08	59VZQC73U09

## Bantam Pavlo Shad 59SP

- High-speed retrieve with kicking action
- 'Jerk Assist Balancer System' increases stability when retrieved quickly
- Special darting action when twitched
- Works with constant and stop/start retrieves
- Excellent action for bouncing on the bottom in shallow water
- Suspending - diving depth 1.7m



59VZM306T	6.0g	59mm	0-1.7m	Suspend	001	002	003	004	005	006	007	008	009	010
					59VZM306T00	59VZM306T01	59VZM306T02	59VZM306T03	59VZM306T04	59VZM306T05	59VZM306T06	59VZP105T07	59VZM306T08	59VZM306T09

## Bantam KoZaK

- Great tight swimming action at all speeds, from super slow to extra fast
- Deep rattle sound when moving
- Natural horizontal profile when being retrieved
- Available in SR (shallow runner) and MR (medium runner)
- Floating - diving depth SR - 1.0m, MR - 1.5m



59VZP205T	8.0g	54mm	0-1.0m	Floating	001	002	003	004	005	006	007	008	009	010
					59VZP205T00	59VZP205T01	59VZP205T02	59VZP205T03	59VZP205T04	59VZP205T05	59VZP205T06	59VZP205T07	59VZP205T08	59VZP205T09
59VZP305T	8.0g	54mm	0-1.5m	Floating	001	002	003	004	005	006	007	008	009	010
					59VZP305T00	59VZP305T01	59VZP305T02	59VZP305T03	59VZP305T04	59VZP305T05	59VZP305T06	59VZP305T07	59VZP305T08	59VZP305T09

NEW

## Bantam WorldRush 56F FLASHBOOST

- Compact body floating crankbait with a 2m deep diving depth
- FLASH BOOST technology reflects light even when stationary
- SCALE BOOST for remarkable life-like scale reality
- Works best with a smooth crank and pause retrieve



001 Black Chart    002 Black Gold    003 Black Back    004 Natural Gil  
 005 Sexy GS    006 Red Craw    007 Green Craw    008 Green C  
 009 Brown B    010 Blue Chart

59VZQC56V	16g	56mm	0-2.0m	Floating	001	002	003	004	005	006	007	008	009	010
					59VZQC56V00	59VZQC56V01	59VZQC56V02	59VZQC56V03	59VZQC56V04	59VZQC56V05	59VZQC56V06	59VZQC56V07	59VZQC56V08	59VZQC56V09

## Bantam Rattlin Sur-Vibe

- Slim square body shape with a fast vibrating action
- Loud rattle sound when moving
- Can be worked with a steady retrieve or life and fall technique
- Head down design and buoyant tail works well on the bottom
- Sinking for fishing variable depths



001 Hasu    002 Matte Grill    003 Red Claw    004 Pond Smelt  
 005 Ayu    006 Chart Gill    007 Black Gold    008 Tiger  
 009 SExy Shad    010 Pure Chart

59VZV107T	14.0g	62mm	Variable	Sinking	001	002	003	004	005	006	007	008	009	010
					59VZV107T00	59VZV107T01	59VZV107T02	59VZV107T03	59VZV107T04	59VZV107T05	59VZV107T06	59VZV107T07	59VZV107T08	59VZV107T09

## Bantam Bt Spin

- Enticing swimming action with increased vibration and spinning rear blade
- Sinking - for fishing through the full water column
- SCALE BOOST, 3D holographic film for remarkable life-like scale reality
- Exceptionally versatile, the BT Spin can be used with a constant retrieve mid-water or with a lift, fall, stop technique that mimics a fish swimming and hiding on the bottom



001 Black Gold    002 Flash WS  
 003 Chart Wh    004 Baby Gill  
 005 Red Claw    006 Blue Chart    007 Red Gold    008 Pink Candy  
 009 Kyorin WS    010 Kyorin KK    011 Kyorin CH    012 Kyorin SV

					001	002	003	004	005	006
59VZRV45S	14.0g	45mm	Variable	Sinking	59VZRV45S00	59VZRV45S01	59VZRV45S02	59VZRV45S03	59VZRV45S04	59VZRV45S05
59VZRW45S	18.0g	45mm	Variable	Sinking	59VZRW45S00	59VZRW45S01	59VZRW45S02	59VZRW45S03	59VZRW45S04	59VZRW45S05
					007	008	009	010	011	012
59VZRV45S	14.0g	45mm	Variable	Sinking	59VZRV45S06	59VZRV45S07	59VZRV45S08	59VZRV45S09	59VZRV45S0A	59VZRV45S0B
59VZRW45S	18.0g	45mm	Variable	Sinking	59VZRW45S06	59VZRW45S07	59VZRW45S08	59VZRW45S09	59VZRW45S0A	59VZRW45S0B

# BANTAM FRESHWATER LURES

## Bantam RipFlash 115F

- Floating minnow designed for ripping and jerking retrieves
- Extremely buoyant with square body creates swaying 'Shimmy Float Action' when ascending
- 'Jerk Assist Balancer System' increases stability when retrieved quickly
- Low tone rattle when jerked and ripped
- Floating - diving depth F (111) - 1.0m, FMD (211) - 1.8m



59VZM111T



59VZM211T



					001	002	003	004	005	006	007	008	009	010
59VZM111T	14.0g	115mm	0-1.0m	Floating	59VZM111T00	59VZM111T01	59VZM111T02	59VZM111T03	59VZM111T04	59VZM111T05	59VZM111T06	59VZM111T07	59VZM111T08	59VZM111T09
					001	002	003	004	005	006	007	008	009	010
59VZM211T	14.0g	115mm	0-1.8m	Floating	59VZM211T00	59VZM211T01	59VZM211T02	59VZM211T03	59VZM211T04	59VZM211T05	59VZM211T06	59VZM211T07	59VZM211T08	59VZM211T09

## Bantam World Minnow 115 SP FLASHBOOST

- Tight swimming action when retrieved at a constant speed plus a wide, aggressive, sliding-type action when twitched and jerked
- Centre balanced for correct positioning when paused
- Suspending – diving depth 1.5m
- FLASH BOOST technology allows the lure to constantly emit an attractive flash, even when stationary
- JET BOOST system for increased casting distance
- SCALE BOOST, 3D holographic film for remarkable life-like scale reality



					001	002	003	004	005	006
59VZQK12T	17.0g	115mm	0-1.5m	Suspend	59VZQK12T00	59VZQK12T01	59VZQK12T02	59VZQK12T03	59VZQK12T04	59VZQK12T04
					007	008	009	010	011	012
59VZQK12T	17.0g	115mm	0-1.5m	Suspend	59VZQK12T06	59VZQK12T07	59VZQK12T08	59VZQK12T09	59VZQK12T0A	59VZQK12T0B

## Bantam World Pop 69F FLASHBOOST

- Floating with a tail down position
- FLASH BOOST technology allows the lure to constantly emit an attractive flash, even when stationary
- SCALE BOOST, 3D holographic film for remarkable life-like scale reality
- A versatile surface popper which can be used in two different ways. When retrieved using regular, small jerks a 'Walk the dog' action can be attained, whilst aggressive jerks, and sweeps produce a popping action that creates a large water disturbance and fish attracting noise

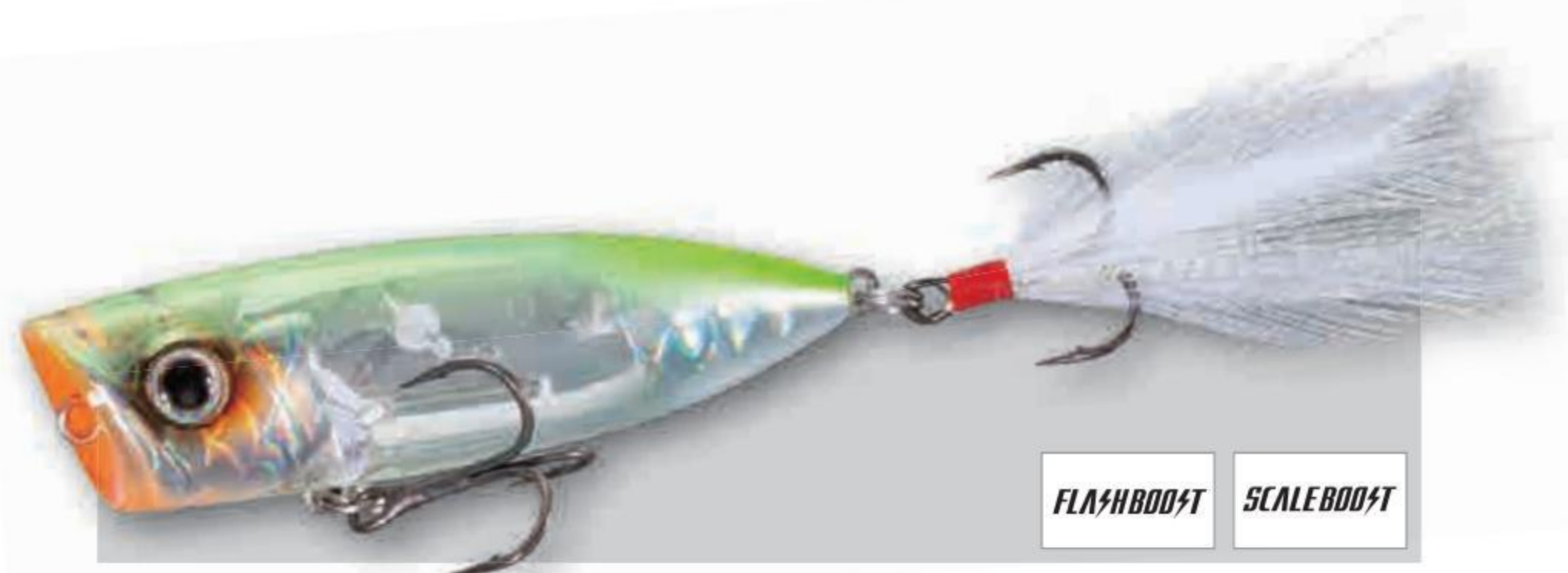

					001	002	003	004	005	006	007	008	009	010
59VZRP69U	11.0g	69mm	-	Floating	59VZRP69U00	59VZRP69U01	59VZRP69U02	59VZRP69U03	59VZRP69U04	59VZRP69U05	59VZRP69U06	59VZRP69U07	59VZRP69U08	59VZRP69U09



# DEPTH CHART



## CARDIFF FRESHWATER LURES

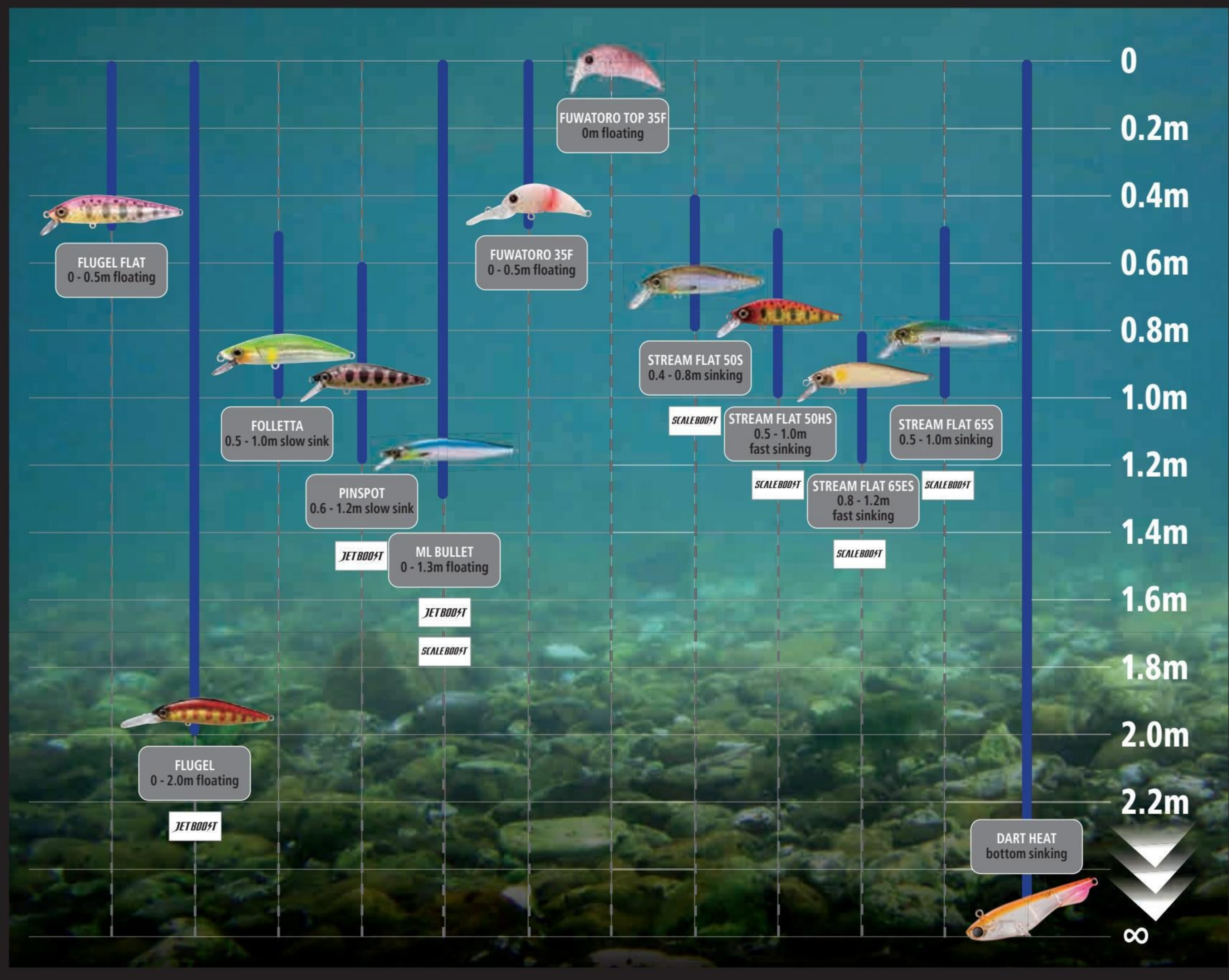

# CARDIFF FRESHWATER LURES



**NEW**

## CARDIFF StreamFlat 50S/50HS/65S/65ES

- Sinking wobbler designed for trout fishing in streams and rivers
- Large front blade grips water for almost instantaneous erratic action
- SCALE BOOST technology for life-like visual presentation in clear water
- Extremely stable, even in strong turbulent flows



					001	002	003	004	005	006	007	008
59VZN250T	3.6g	50mm	0.4m-0.8m	Sinking	59VZN250T00	59VZN250T01	59VZN250T02	59VZN250T03	59VZN250T04	59VZN250T05	59VZN250T06	59VZN250T07
					009	010	011	012	013	014	015	
59VZN250T	3.6g	50mm	0.4m-0.8m	Sinking	59VZN250T08	59VZN250T09	59VZN250T0A	59VZN250T0B	59VZN250T0C	59VZN250T0D	59VZN250T0E	
					001	002	003	004	005	006	007	008
59VZN350T	4.5g	50mm	0.5m-1.0m	Fast Sinking	59VZN350T00	59VZN350T01	59VZN350T02	59VZN350T03	59VZN350T04	59VZN350T05	59VZN350T06	59VZN350T07
					009	010	011	012	013	014	015	
59VZN350T	4.5g	50mm	0.5m-1.0m	Fast Sinking	59VZN350T08	59VZN350T09	59VZN350T0A	59VZN350T0B	59VZN350T0C	59VZN350T0D	59VZN350T0E	
					001	002	003	004	005	006	007	008
59VZN265T	6.3g	65mm	0.5m-1.0m	Sinking	59VZN265T00	59VZN265T01	59VZN265T02	59VZN265T03	59VZN265T04	59VZN265T05	59VZN265T06	59VZN265T07
					009	010	011	012	013	014	015	
59VZN265T	6.3g	65mm	0.5m-1.0m	Sinking	59VZN265T08	59VZN265T09	59VZN265T0A	59VZN265T0B	59VZN265T0C	59VZN265T0D	59VZN265T0E	
					001	002	003	004	005	006	007	008
59VZN365T	9.2g	65mm	0.8m-1.2m	Fast Sinking	59VZN365T00	59VZN365T01	59VZN365T02	59VZN365T03	59VZN365T04	59VZN365T05	59VZN365T06	59VZN365T07
					009	010	011	012	013	014	015	
59VZN365T	9.2g	65mm	0.8m-1.2m	Fast Sinking	59VZN365T08	59VZN365T09	59VZN365T0A	59VZN365T0B	59VZN365T0C	59VZN365T0D	59VZN365T0E	

CARDIFF **Flügel Flat** 70F

- Floating minnow design with extremely life-like details and colours
- Magnet weight transfer for longer casting distance and improved action
- Wide swimming action when retrieved with a constant speed
- Flashing action when fished with small jerks
- Floating - diving depth 0.5m



59VZNM70T	5.0g	70mm	0-0.5m	Floating	001	002	003	004	005	006	007	008	009
-----------	------	------	--------	----------	-----	-----	-----	-----	-----	-----	-----	-----	-----

CARDIFF **Flügel** 70F *ARC*

- Deep running, highly stable floating minnow
- JET BOOST system for increased casting distances
- Stable running, even at high speed and in strong currents
- Exceptional darting action when giving small jerks
- Floating - diving depth 2.0m



59VZN170T	7.8g	70mm	0-2.0m	Floating	001	002	003	004	005	006	007	008
-----------	------	------	--------	----------	-----	-----	-----	-----	-----	-----	-----	-----

CARDIFF **ML Bullet** 93F *JETBOOST*

- Smooth enticing swimming action when retrieved with a constant speed, or aggressive darting when paused and jerked
- Quick start-up action on retrieve
- Floating - 1.3 diving depth
- JET BOOST system for increased casting distance
- SCALE BOOST, 3D holographic film for remarkable life-like scale reality



59VZNM93U	10g	93mm	0-1.3m	Floating	001	002	003	004	005	006	007	008
-----------	-----	------	--------	----------	-----	-----	-----	-----	-----	-----	-----	-----

# CARDIFF FRESHWATER LURES



## CARDIFF Folletta

- Slow sinking minnow with fixed centre of gravity
- Wide kicking action when twitched
- Tight rolling action on constant retrieve
- Highly realistic patterns and colours
- Slow Sinking - diving depth 1.0m



					001	002	003	004	005	006
59VTN251T	3.3g	50mm	0.5-1.0m	Slow Sink	59VTN251T00	59VTN251T01	59VTN251T02	59VTN251T03	59VTN251T04	59VTN251T05
					007	008	009	010	011	
59VTN251T	3.3g	50mm	0.5-1.0m	Slow Sink	59VTN251T06	59VTN251T07	59VTN251T08	59VTN251T09	59VTN251T0A	



## CARDIFF PINSPOT 50s ARC

- Small size sinking minnow design
- JET BOOST system for increased casting distance
- Wide erratic kicking action when twitched
- Tight rolling action on constant retrieve
- Flat sided body creates increased flash
- Sinking - diving depth 1.2m

JET BOOST



					001	002	003	004	005	006	007	008	009	010
59VTN250T	3.5g	50mm	0.6-1.2m	Sinking	59VTN250T00	59VTN250T01	59VTN250T02	59VTN250T03	59VTN250T04	59VTN250T05	59VTN250T06	59VTN250T07	59VTN250T08	59VTN250T09

## CARDIFF FUWATORO TOP

- Small floating top water jointed crankbait for trout and chub
- Designed for ultra slow retrieve
- Enticing wobbling body action even at the slowest speeds
- Large front lip for extra splash when twitched
- Floating - diving depth 0m



001

002

003

004

005

006

007

008

009

010

59VTR035T

2.5g

35mm

0m

Floating

59VTR035T00

59VTR035T01

59VTR035T02

59VTR035T03

59VTR035T04

59VTR035T05

59VTR035T06

59VTR035T07

59VTR035T08

59VTR035T09

## CARDIFF FUWATORO

- One of Japan's best selling Trout Area lures
- Easy to use small floating jointed crankbait
- Designed for ultra slow retrieve
- Enticing wobbling body action even at the slowest speeds
- Floating - diving depth 0.5m



001

002

003

004

005

006

007

008

009

010

59VTR135T

2.5g

35mm

0-0.5m

Floating

59VTR135T00

59VTR135T01

59VTR135T02

59VTR135T03

59VTR135T04

59VTR135T05

59VTR135T06

59VTR135T07

59VTR135T08

59VTR135T09

## CARDIFF DART HEAT

- Special darting action when giving small jerks
- Attractive wobble during the descend
- Stand-up position on the bottom
- Excellent lure for deep water trout fishing
- Sinking



001

002

003

004

005

006

007

008

009

010

59VTN246T

4.6g

47mm

-

Sinking

59VTN246T00

59VTN246T01

59VTN246T02

59VTN246T03

59VTN246T04

59VTN246T05

59VTN246T06

59VTN246T07

59VTN246T08

59VTN246T09

# CARDIFF FRESHWATER LURES

## CARDIFF *Slim Swimmer*

- Ideal for trout fishing
- Long, narrow microspoon that distributes the weight of the wave over a wider surface, allowing the spoon to sink very slowly
- A wave with excellent casting quality
- Perfect for probing surface water layers
- Available in 3 camo colours, 4 solid colours and various two tone gold/silver premium plating options
- CE - 'a Compact Edition' is available in selected colours



**CE**  
Compact Edition (CE) maintains the lure length but increases the body volume for longer casting, easier swimming action and better depth.



CAMO			22T	23T	24T
5VTRA20R	2.0g	28mm	5VTRA20R22	5VTRA20R23	5VTRA20R24
5VTRA36R	3.6g	33mm	5VTRA36R22	5VTRA36R23	5VTRA36R24
5VTRA44R	4.4g	40mm	5VTRA44R22	5VTRA44R23	5VTRA44R24

PREMIUM			05S	12S	15S	16S	60T	62T	63T	64T	65T	66T
5VTRS20N	2.0g	28mm	5VTRS20N05	5VTRS20N12	5VTRS20N15	5VTRS20N16	5VTRS20N60	5VTRS20N62	5VTRS20N63	5VTRS20N64	5VTRS20N65	5VTRS20N66
5VTRS36N	3.6g	33mm	5VTRS36N05	5VTRS36N12	5VTRS36N15	5VTRS36N16	5VTRS36N60	5VTRS36N62	5VTRS36N63	5VTRS36N64	5VTRS36N65	5VTRS36N66
5VTRS44N	4.4g	40mm	5VTRS44N05	5VTRS44N12	5VTRS44N15	5VTRS44N16	5VTRS44N60	5VTRS44N62	5VTRS44N63	5VTRS44N64	5VTRS44N65	5VTRS44N66

## CARDIFF *Wobble Swimmer*

- A Trout Area game spoon with single hooks
- Specific for trout fishing in a pond
- The last wave model added to the 'Cardiff' family
- Available in 4 camo colours and 4 two tone designs



			03T	06T	21T	22T	23T	24T	25T	63T
5VTR015L	1.5g	28mm	5VTR015L03	5VTR015L06	5VTR015L21	5VTR015L22	5VTR015L23	5VTR015L24	5VTR015L25	5VTR015L63
5VTR025L	2.5g	30mm	5VTR025L03	5VTR025L06	5VTR025L21	5VTR025L22	5VTR025L23	5VTR025L24	5VTR025L25	5VTR025L63



CARDIFF  
*Roll Swimmer*

- A Trout Area game spoon with single hooks
- These have an irresistible roll which will fool not only wary Trout but also Perch!
- Available in 3 camo colours, solid colours and various two tone gold/silver premium plating options
- CE - 'a Compact Edition' is available in all 4.5g models



CAMO	g	mm	22T	23T	24T
5VTRC15R	1.5g	21mm	5VTRC15R22	5VTRC15R23	5VTRC15R24
5VTRC25R	2.5g	28mm	5VTRC25R22	5VTRC25R23	5VTRC25R24
5VTRC35R	3.5g	28mm	5VTRC35R22	5VTRC35R23	5VTRC35R24
5VTRC45R	4.5g	29mm	5VTRC45R22	5VTRC45R23	5VTRC45R24

PREMIUM	g	mm	70T	71T	72T	73T	75T	77T	78T
5VTRM15R	1.5g	21mm	5VTRM15R70	5VTRM15R71	5VTRM15R72	5VTRM15R73	5VTRM15R75	5VTRM15R77	5VTRM15R78
5VTRM25R	2.5g	28mm	5VTRM25R70	5VTRM25R71	5VTRM25R72	5VTRM25R73	5VTRM25R75	5VTRM25R77	5VTRM25R78
5VTRM35R	3.5g	28mm	5VTRM35R70	5VTRM35R71	5VTRM35R72	5VTRM35R73	5VTRM35R75	5VTRM35R77	5VTRM35R78

CE	g	mm	05S	12S	16S	60T	62T	63T	64T	65T	66T
5VTRR45N	4.5g	29mm	5VTRR45N05	5VTRR45N12	5VTRR45N16	5VTRR45N60	5VTRR45N62	5VTRR45N63	5VTRR45N64	5VTRR45N65	5VTRR45N66



CARDIFF  
*Search Swimmer*

- A Trout Area game spoon with single hooks
- Available in various solid colours and 4 two tone gold/silver premium plating options



	g	mm	03S	05S	06S	08S	12S	16S	62T	63T	64T	66T
5VTR218Q	1.8g	25mm	5VTR218QC3	5VTR218QC5	5VTR218QC6	5VTR218QC8	5VTR218QD2	5VTR218QD6	5VTR218Q62	5VTR218Q63	5VTR218Q64	5VTR218Q66
5VTR225Q	2.5g	27mm	5VTR225QC3	5VTR225QC5	5VTR225QC6	5VTR225QC8	5VTR225QD2	5VTR225QD6	5VTR225Q62	5VTR225Q63	5VTR225Q64	5VTR225Q66
5VTR235Q	3.5g	28mm	5VTR235QC3	5VTR235QC5	5VTR235QC6	5VTR235QC8	5VTR235QD2	5VTR235QD6	5VTR235Q62	5VTR235Q63	5VTR235Q64	5VTR235Q66

# DEPTH CHART



## EXSENCE SALTWATER LURES

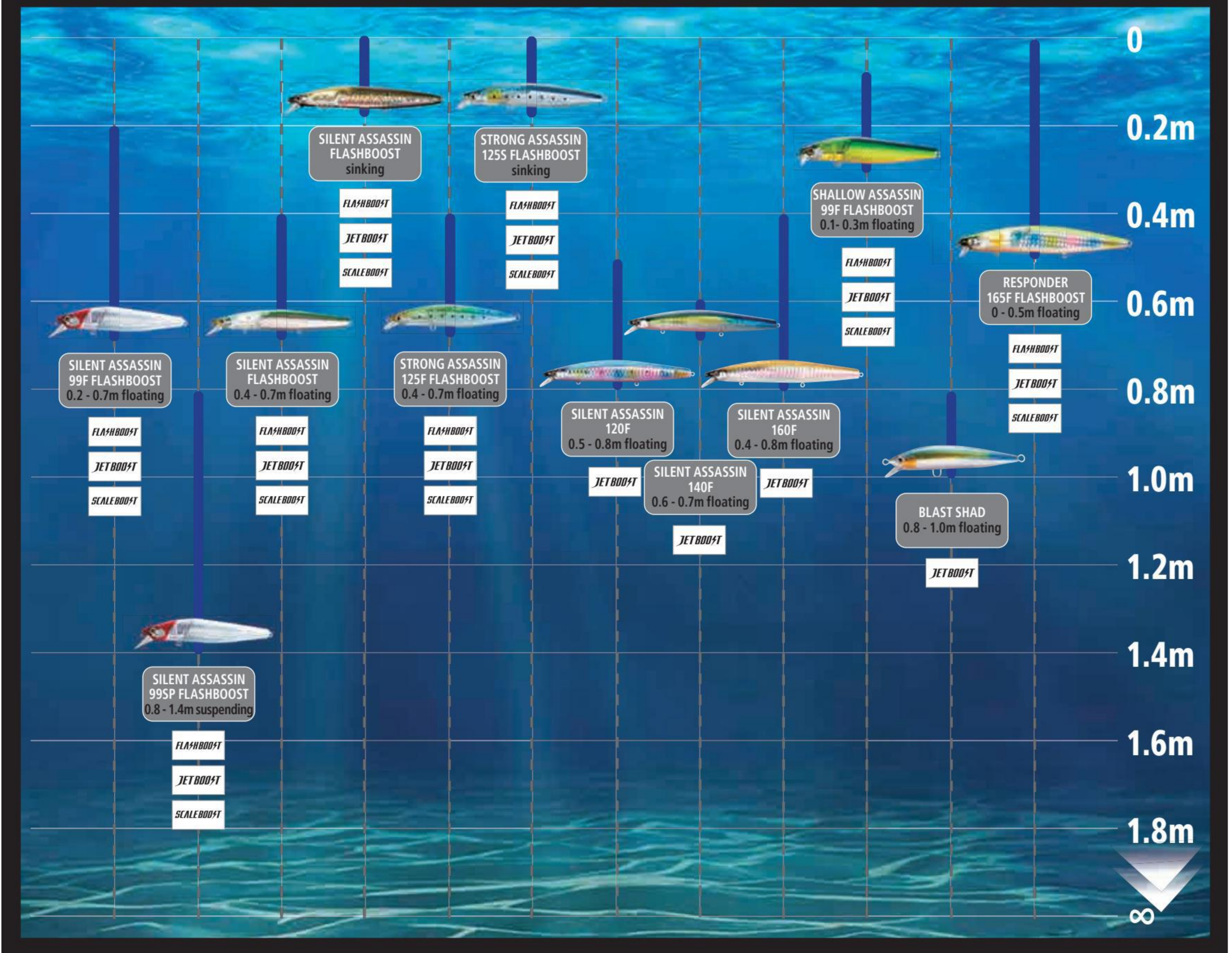





# EXSENCE

## Silent Assassin 129F/129S FLASH BOOST

- Rolling tight action when retrieved at a constant speed, or long powerful glides when jerked
- JET BOOST system for increased casting distance with 65 metres possible
- Floating – 0.7 diving depth
- FLASH BOOST technology for constant flashing attraction
- SCALE BOOST, 3D holographic film for remarkable life-like scale reality
- Equipped with three SW treble hooks
- Designed for Sea Bass, but equally suited to other top water predators, the Silent Assassin has a world-wide pedigree, which is set to be enhanced further by the inclusion of SHIMANO FLASH BOOST

FLASH BOOST

JET BOOST

SCALE BOOST

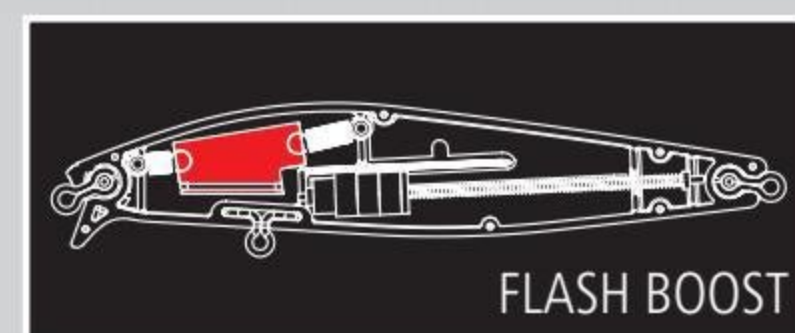

FLASH BOOST



	g	mm	m		001	002	003	004	005	006	007	008
59VXM112T	24g	129mm	0.40-0.70m	Floating	59VXM112T00	59VXM112T01	59VXM112T02	59VXM112T03	59VXM112T04	59VXM112T05	59VXM112T06	59VXM112T07
59VXM212T	26g	129mm	-	Sinking	59VXM212T00	59VXM212T01	59VXM212T02	59VXM212T03	59VXM212T04	59VXM212T05	59VXM212T06	59VXM212T07

NEW

# EXSENCE

## Silent Assassin 99F/99SP FLASH BOOST

- FLASH BOOST technology for constant flashing attraction
- JET BOOST for increased distance casting performance
- SCALE BOOST 3D holographic film for remarkable life-like scale reality
- Available in suspending (SP) and floating (F) versions

FLASH BOOST

JET BOOST

SCALE BOOST

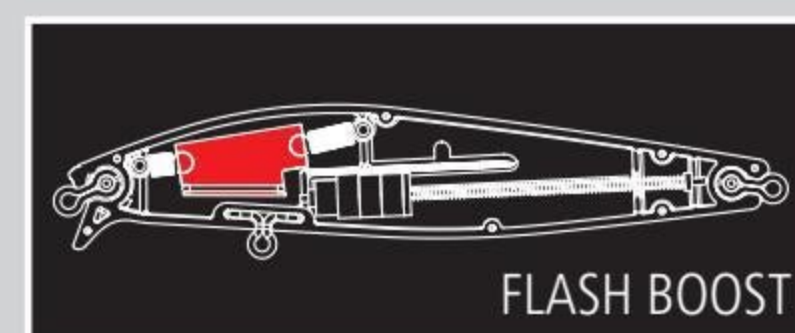

FLASH BOOST



	g	mm	m		001	002	003	004	005	006	007	008
59VXM299V	14g	99mm	0.20-0.70m	Floating	59VXM299V00	59VXM299V01	59VXM299V02	59VXM299V03	59VXM299V04	59VXM299V05	59VXM299V06	59VXM299V07
59VXM999V	16g	99mm	0.80-1.40m	Suspending	59VXM999V00	59VXM999V01	59VXM999V02	59VXM999V03	59VXM999V04	59VXM999V05	59VXM999V06	59VXM999V07

# EXSENCE SALTWATER LURES



## EXSENCE

### Silent Assassin 140F/140S *FLASHBOOST*

- Rolling tight action when retrieved at a constant speed, or long powerful glides when jerked
- JET BOOST system for increased casting distance with 70 metres possible
- FLASH BOOST technology for constant flashing attraction
- SCALE BOOST, 3D holographic film for remarkable life-like scale reality
- Equipped with three SW treble hooks
- Designed for Sea Bass, but equally suited to other top water predators, the Silent Assassin has a world-wide pedigree, which is set to be enhanced further by the inclusion of SHIMANO FLASH BOOST



					001	002	003	004	005	006	007	008
59VXM214T	28g	140mm	-	Sinking	59VXM214T00	59VXM214T01	59VXM214T02	59VXM214T03	59VXM214T04	59VXM214T05	59VXM214T06	59VXM214T07
59VXM314T	25g	140mm	0.40-0.70m	Floating	59VXM314T00	59VXM314T01	59VXM314T02	59VXM314T03	59VXM314T04	59VXM314T05	59VXM314T06	59VXM314T07



## EXSENCE

### Strong Assassin 125F/125S *FLASHBOOST*

- Wide wobbling action when retrieved at a constant speed, or long powerful glides when jerked
- JET BOOST system for increased casting distance with 70 metres possible
- Floating – 0.7 diving depth
- FLASH BOOST technology for constant flashing attraction
- SCALE BOOST, 3D holographic film for remarkable life-like scale reality
- Equipped with two SW treble hooks
- Designed for Sea Bass, but equally suited to other top water and sub-surface predators



					001	002	003	004	005	006	007	008
59VXM112U	25g	125mm	0.40-0.70m	Floating	59VXM112U00	59VXM112U01	59VXM112U02	59VXM112U03	59VXM112U04	59VXM112U05	59VXM112U06	59VXM112U07
59VXM212U	27g	125mm	-	Sinking	59VXM212U00	59VXM212U01	59VXM212U02	59VXM212U03	59VXM212U04	59VXM212U05	59VXM212U06	59VXM212U07



# EXSENCE

## Silent Assassin 129F

- Available in the hugely popular 129mm, perfect for sea bass fishing
- Equipped with JET BOOST system for increased casting distance and accuracy
- Floating design for fishing the top layers and surface



59VXM129N	22g	129mm	0.5-0.8m	Floating	01T	001	03T	003	005	08T	006	10T
					59VXM129N01	59VXM129N00	59VXM129N03	59VXM129N02	59VXM129N04	59VXM129N08	59VXM129N05	59VXM129N10

# EXSENCE

## Silent Assassin 140F

- Equipped with JET BOOST system for increased casting distance and accuracy
- Floating design for fishing the top layers and surface



59VXM140N	23g	140mm	0.6-0.7m	Floating	01T	02T	03T	04T	05T	08T	09T	10T
					59VXM140N01	59VXM140N02	59VXM140N03	59VXM140N04	59VXM140N05	59VXM140N08	59VXM140N09	59VXM140N10

# EXSENCE

## Silent Assassin 160F

- Large minnow type lure often used in harbours, estuaries and surf
- Ideal for situations where you want to introduce a big lure that combines distance and action
- Floating design for fishing the top layers and surface



59VXM160S	32g	160mm	0.4-0.8m	Floating	001	002	003	004	005	006	007	008
					59VXM160S00	59VXM160S01	59VXM160S02	59VXM160S03	59VXM160S04	59VXM160S05	59VXM160S06	59VXM160S07

# EXSENCE / ENGETSU SALTWATER LURES

**NEW**

## EXSENCE Responder 165F *FLASHBOOST*

- FLASH BOOST technology for constant flashing attraction
- JET BOOST for increased distance casting performance
- SCALE BOOST 3D holographic film for remarkable life-like scale reality
- Floating - diving depth 0.5m



34g	165mm	0-0.50m	Floating	001	002	003	004	005	006	007	008
59VXM116V				59VXM116V00	59VXM116V01	59VXM116V02	59VXM116V03	59VXM116V04	59VXM116V05	59VXM116V06	59VXM116V07

## EXSENCE Shallow Assassin 99F *FLASHBOOST*

- Floating minnow designed for sea bass fishing
- FLASH BOOST feature increases 'flash' from the lure even when stationary
- Equipped with JET BOOST system for increased casting distance and accuracy
- SCALE BOOST 3D holographic film for remarkable life-like scale reality
- Floating - diving depth 0.3m



14g	99mm	0.10-0.30m	Floating	001	002	003	004	005	006	007	008
59VXM199T				59VXM199T00	59VXM199T01	59VXM199T02	59VXM199T03	59VXM199T04	59VXM199T05	59VXM199T06	59VXM199T07

## EXSENCE BLAST SHAD

- Medium/large floating minnow which creates a lot of disturbance
- Fast rolling and flashing action
- Dives to 1.0m to cover sub-surface feeding fishing
- Equipped with JET BOOST system for increased casting distance and accuracy
- Floating - diving depth 1.0m



35g	140mm	0.8-1.0m	Floating	001	002	003	004	005	006	007	008
59VXM114T				59VXM114T00	59VXM114T01	59VXM114T02	59VXM114T03	59VXM114T04	59VXM114T05	59VXM114T06	59VXM114T07



NEW

## ENGETSU

### Doteru BakuBaku

- Slim head profile sinks quickly and stays in the zone longer
- 3D holographic eyes for increased attraction
- Enhanced colour combinations and special high movement silicon skirts
- Twin assist hooks for more reliable hook-ups
- Fluorine coating on hooks for better hook-set



				001	002	003	004
59VJDL08V	80g	-	Sinking	59VJDL08V00	59VJDL08V01	59VJDL08V02	59VJDL08V03
59VJDL10V	100g	-	Sinking	59VJDL10V00	59VJDL10V01	59VJDL10V02	59VJDL10V03
59VJDL12V	120g	-	Sinking	59VJDL12V00	59VJDL12V01	59VJDL12V02	59VJDL12V03
59VJDL15V	150g	-	Sinking	59VJDL15V00	59VJDL15V01	59VJDL15V02	59VJDL15V03
59VJDL20V	200g	-	Sinking	59VJDL20V00	59VJDL20V01	59VJDL20V02	59VJDL20V03



SCALE BOOST

## ENGETSU

### Kyorin BakuBaku

- Classic Baku Baku vertical action
- Head shape creates complex flow of water with additional movement from the silicone tails
- 3D holographic eye for increased attraction
- SCALE BOOST, 3D holographic film on the head for remarkable life-like scale reality



				001	002	003	004	005
59VJDR45U	45g	10+m	Sinking	59VJDR45U00	59VJDR45U01	59VJDR45U02	59VJDR45U03	59VJDR45U04
59VJDR60U	60g	10+m	Sinking	59VJDR60U00	59VJDR60U01	59VJDR60U02	59VJDR60U03	59VJDR60U04
59VJDR80U	80g	10+m	Sinking	59VJDR80U00	59VJDR80U01	59VJDR80U02	59VJDR80U03	59VJDR80U04
59VJDR10U	100g	10+m	Sinking	59VJDR10U00	59VJDR10U01	59VJDR10U02	59VJDR10U03	59VJDR10U04
59VJDR12U	120g	10+m	Sinking	59VJDR12U00	59VJDR12U01	59VJDR12U02	59VJDR12U03	59VJDR12U04
59VJDR15U	150g	10+m	Sinking	59VJDR15U00	59VJDR15U01	59VJDR15U02	59VJDR15U03	59VJDR15U04
59VJDR20U	200g	10+m	Sinking	59VJDR20U00	59VJDR20U01	59VJDR20U02	59VJDR20U03	59VJDR20U04

# SOARE / OCEA SALTWATER LURES



## Soare A-JIG

- Horizontal, slow action, free fall metal jig
- Specifically designed for mackerel fishing
- In free fall, the centre of gravity is towards the front which accelerates the descent
- Available in 4 colour patterns



001 Iwashi



002 Pink Zebra



003 Gold



005 Chart Gold

					001	002	003	005
59VSS265Q	6.5g	35mm	10+m	Sinking	59VSS265Q00	59VSS265Q01	59VSS265Q02	59VSS265Q04



## Soare Metal shot *TG*

- Made from high density tungsten producing a compact body profile
- Designed for micro jigging
- Falls to the bottom more quickly than lead alternatives
- Special natural holographic design perfectly mimics a wounded baitfish
- Can be used from the shore or vertically from a boat



Made of Tungsten

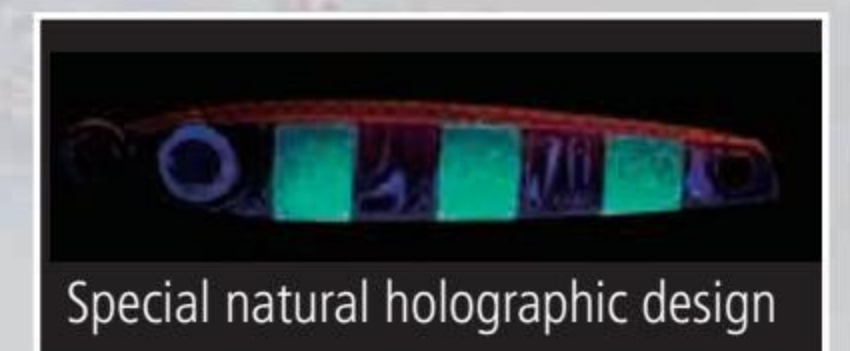

Special natural holographic design



001 Silver



002 Pink Zebra



003 Blue Back



004 Zebra Glow

					001	002	003	004
59VSS203T	3g	25mm	10+m	Sinking	59VSS203T00	59VSS203T01	59VSS203T02	59VSS203T03
59VSS205T	5g	30mm	10+m	Sinking	59VSS205T00	59VSS205T01	59VSS205T02	59VSS205T03
59VSS207T	7g	35mm	10+m	Sinking	59VSS207T00	59VSS207T01	59VSS207T02	59VSS207T03

NEW

**OCEA BOMB DIP 170F FLASHBOOST**

- Highly technical 'popper' for tuna, GT and other large surface feeders
- Advanced front cup design creates large 'popping' sound
- JET BOOST technology increases casting distance and accuracy
- FLASH BOOST reflects light, to increase attractiveness, even when stationary

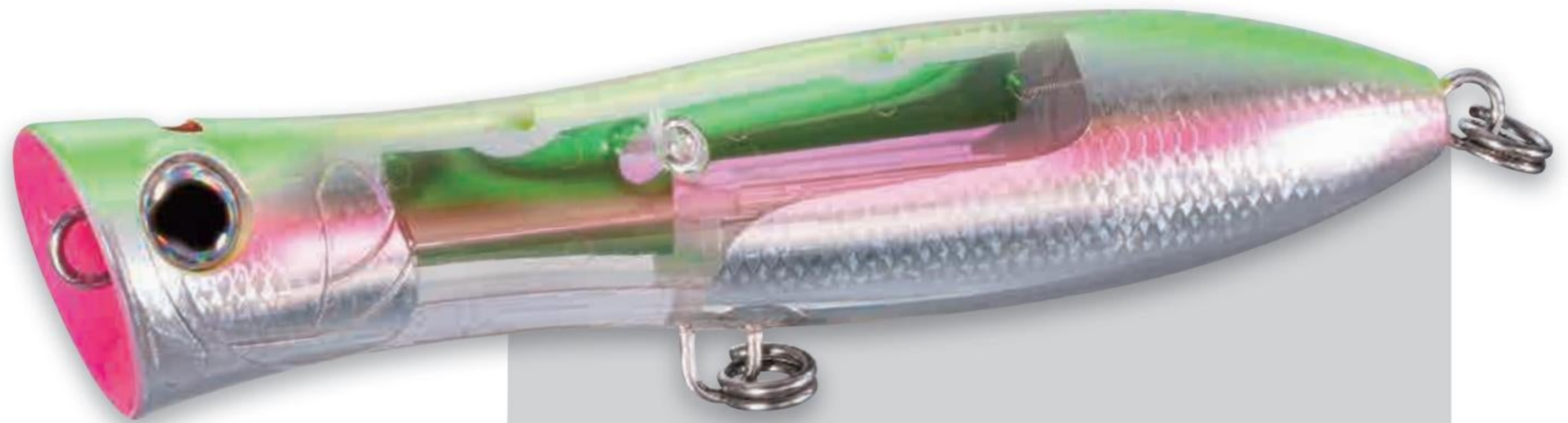

FLASHBOOST

JETBOOST



001 Iwashi



002 Pink



003 Anchovy



004 Tobiuo



005 Green



006 Rainbow



72g



170mm



-



Floating

001

59VXUP17V00

002

59VXUP17V01

003

59VXUP17V02

004

59VXUP17V03

005

59VXUP17V04

006

59VXUP17V05

59VXUP17V

NEW

**OCEA HEAD DIP 140F FLASHBOOST**

- Classic Stickbait action with head-up buoyancy for effective pauses
- Designed for tuna and other hard feeding pelagic species
- JET BOOST system for increased casting distance to feeding fish
- FLASH BOOST technology for constant flashing attraction
- SCALE BOOST, 3D holographic film for remarkable life-like scale reality
- Equipped with two 3/0 sized heavy duty treble hooks
- The compact 140mm size of the Ocea Head Dip works perfectly when pelagic species are feeding on shoals of bait fish, especially where long range casting is required



FLASHBOOST

JETBOOST

SCALEBOOST



001 Maiwashi



002 Pink



003 Katakuchi



004 Tobiuo



005 Green



006 Rainbow



70g



140mm



Subsurface



Floating

001

59VXUT14U00

002

59VXUT14U01

003

59VXUT14U02

004

59VXUT14U03

005

59VXUT14U04

006

59VXUT14U05

59VXUT14U

# OCEA SALTWATER LURES



NEW





## OCEA

### Stinger Butterfly Pebble Light

- Designed for lightweight and super lightweight offshore jigging
- Life-like SCALE BOOST finish for increased attractiveness
- Foil additions to front hooks for additional visibility
- Easy to use versatile action for maximum impact

SCALE BOOST



					001	002	003	004	005	006
59VJUP40U	40g	92mm	-	Sinking	59VJUP40U00	59VJUP40U01	59VJUP40U02	59VJUP40U03	59VJUP40U04	59VJUP40U05
59VJUP60U	60g	105mm	-	Sinking	59VJUP60U00	59VJUP60U01	59VJUP60U02	59VJUP60U03	59VJUP60U04	59VJUP60U05



NEW





## OCEA

### Stinger Butterfly Flat Light

- Designed for lightweight and super lightweight offshore jigging
- Life-like SCALE BOOST finish for increased attractiveness
- Foil additions to front hooks for additional visibility
- Versatile slow falling action for maximum impact

SCALE BOOST



					001	002	003	004	005	006
59VJUS30S	30g	58mm	-	Sinking	59VJUS30S00	59VJUS30S01	59VJUS30S02	59VJUS30S03	59VJUS30S04	59VJUS30S05
59VJUS40S	40g	66mm	-	Sinking	59VJUS40S00	59VJUS40S01	59VJUS40S02	59VJUS40S03	59VJUS40S04	59VJUS40S05
59VJUS50S	50g	72mm	-	Sinking	59VJUS50S00	59VJUS50S01	59VJUS50S02	59VJUS50S03	59VJUS50S04	59VJUS50S05
59VJUS60S	60g	77mm	-	Sinking	59VJUS60S00	59VJUS60S01	59VJUS60S02	59VJUS60S03	59VJUS60S04	59VJUS60S05
59VJUS80S	80g	85mm	-	Sinking	59VJUS80S00	59VJUS80S01	59VJUS80S02	59VJUS80S03	59VJUS80S04	59VJUS80S05



# OCEA

## Stinger Butterfly Wing

- Designed for slow jigging style
- The specially designed contours on the body impart a sliding motion which mimics injured prey
- When released it will slowly flutter replicating a falling dead fish
- UV glow eye for increased attraction



					24T	25T	27T	28T	29T	001 / 39T	002	41T
59VJT511M	110g	98mm	10+m	Sinking	59VJT511M24	59VJT511M25	-	59VJT511M28	-	59VJT511M00	59VJT511M01	-
59VJT513M	135g	105mm	10+m	Sinking	59VJT513M24	59VJT513M25	59VJT513M27	59VJT513M28	-	59VJT513M00	59VJT513M01	-
59VJT516M	160g	112mm	10+m	Sinking	59VJT516M24	59VJT516M25	59VJT516M27	59VJT516M28	59VJT516M29	59VJT516M39	-	59VJT516M41

# OCEA

## Stinger Butterfly Sardine Waver

- Can be fished with a variety of actions
- Produces 3 types of actions automatically: back sliding, wobbling fall and slide back and forth
- All-around lure ideal for grouper or tuna
- Available in 4 colour patterns from 130g - 160g

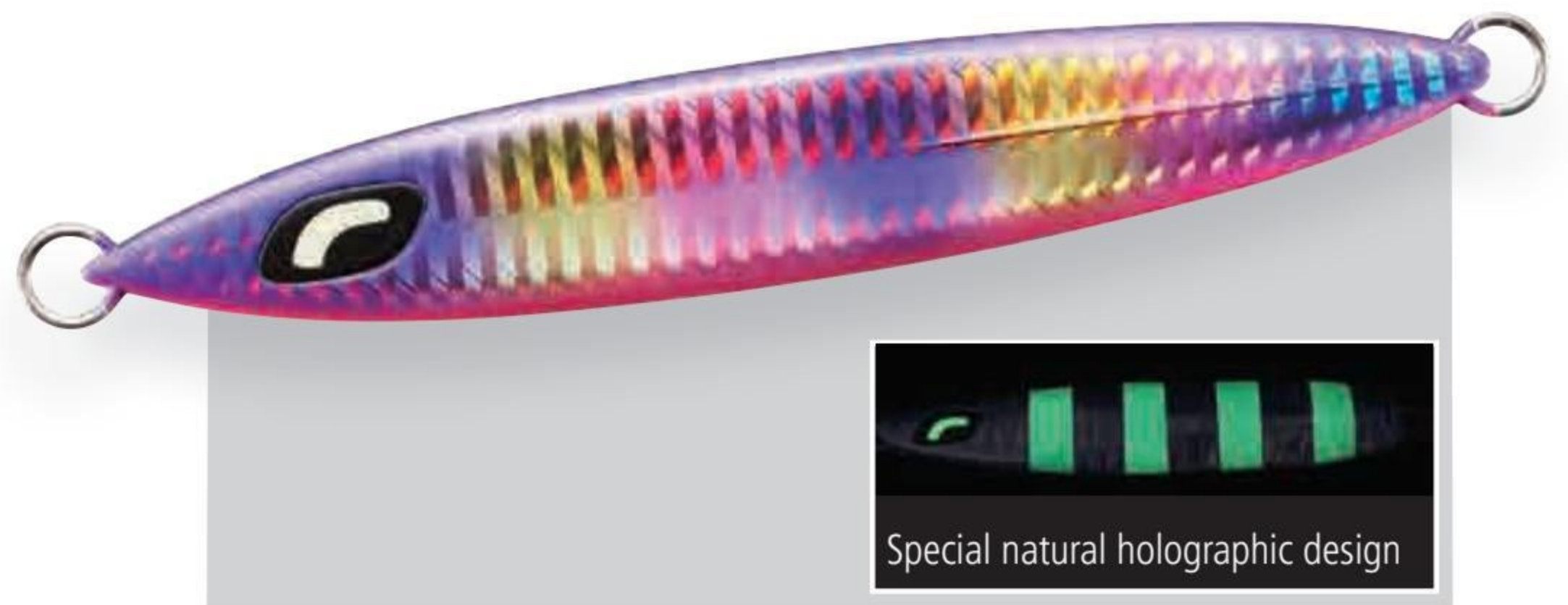

					001	002	003	004	005
59VJT413P	130g	121mm	10+m	Sinking	59VJT413P00	59VJT413P01	59VJT413P02	59VJT413P03	59VJT413P04
59VJT416P	160g	130mm	10+m	Sinking	59VJT416P00	59VJT416P01	59VJT416P02	59VJT416P03	59VJT416P04

# OCEA

## Stinger Butterfly Center Sardine

- Centre balance system creates sliding action followed by a rolling body to imitate injured bait fish
- Discrete flashing, perfectly mimics a wounded baitfish
- Special natural holographic design
- Very effective when slow jigging in a school of baitfish
- Available in 88mm (50g) and 99mm (70g)

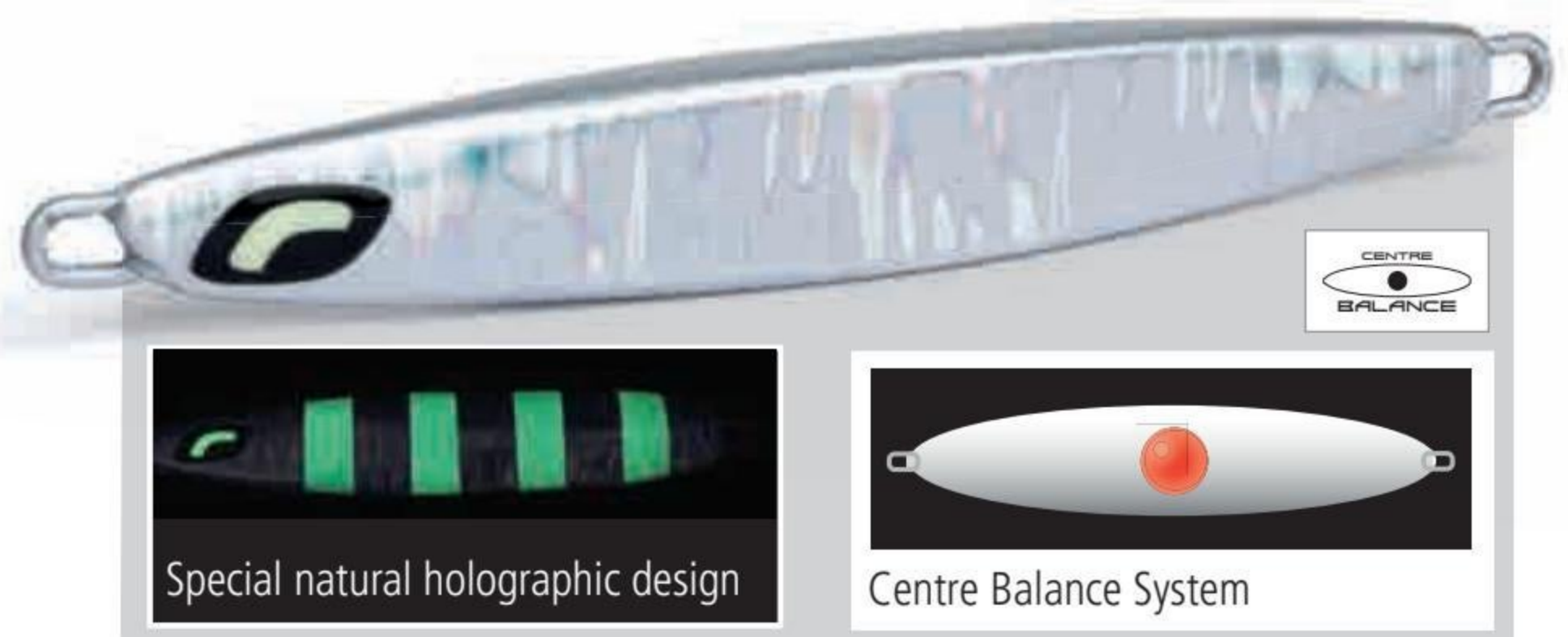

					001	002	003	004	005	006	007	008	009	010	011	012
59VJT705T	50g	88mm	10+m	Sinking	-	-	-	-	59VJT705T05	59VJT705T06	59VJT705T07	59VJT705T08	59VJT705T09	59VJT705T0A	59VJT705T0B	
59VJT707T	70g	99mm	10+m	Sinking	-	-	-	-	59VJT707T05	59VJT707T06	59VJT707T07	59VJT707T08	59VJT707T09	59VJT707T0A	59VJT707T0B	
59VJT707L	70g	99mm	10+m	Sinking	59VJT707L00	59VJT707L01	59VJT707L02	59VJT707L03	59VJT707L04	-	-	-	-	-	-	-
59VJT709L	90g	99mm	10+m	Sinking	59VJT709L00	59VJT709L01	59VJT709L02	59VJT709L03	59VJT709L04	-	-	-	-	-	-	-

# SEPHIA SALTWATER LURES



## Sephia **Clinch Rattle**

- Designed with lumo glow properties (tail only) and UV cloth for maximum attraction
- Ideal for Summer and Autumn
- Very effective in the 3m - 20m depth range
- Sharp edge head for better darting action
- High quality Japanese hooks for assured hooking



		GOU		001	002	003	004	005	006	007
59VQEJ25S	10g	2.5GOU	Sinking - 4 s/m	59VQEJ25S00	59VQEJ25S01	59VQEJ25S02	59VQEJ25S03	59VQEJ25S04	59VQEJ25S05	59VQEJ25S06
59VQEJ30S	15g	3.0GOU	Sinking - 3 s/m	59VQEJ30S00	59VQEJ30S01	59VQEJ30S02	59VQEJ30S03	59VQEJ30S04	59VQEJ30S05	59VQEJ30S06
59VQEJ35S	19g	3.5GOU	Sinking - 3.5 s/m	59VQEJ35S00	59VQEJ35S01	59VQEJ35S02	59VQEJ35S03	59VQEJ35S04	59VQEJ35S05	59VQEJ35S06
		GOU		008	009	010	011	012	013	014
59VQEJ25S	10g	2.5GOU	Sinking - 4 s/m	59VQEJ25S07	59VQEJ25S08	59VQEJ25S09	59VQEJ25S0A	59VQEJ25S0B	59VQEJ25S0C	59VQEJ25S0D
59VQEJ30S	15g	3.0GOU	Sinking - 3 s/m	59VQEJ30S07	59VQEJ30S08	59VQEJ30S09	59VQEJ30S0A	59VQEJ30S0B	59VQEJ30S0C	59VQEJ30S0D
59VQEJ35S	19g	3.5GOU	Sinking - 3.5 s/m	59VQEJ35S07	59VQEJ35S08	59VQEJ35S09	59VQEJ35S0A	59VQEJ35S0B	59VQEJ35S0C	59VQEJ35S0D

FLASH BOOST



## Sephia **Clinch** FLASH BOOST

- Darting action when jerked
- Designed for squid and cuttlefish
- FLASH BOOST technology for constant attraction even when the lure is falling or paused
- Available in 3 sizes, 2.5gou, 3.0gou, 3.5gou
- 16 different exclusive colours



		GOU		001	002	003	004	005	006	007	008
59VQEX25T	10g	2.5GOU	Sinking - 4 s/m	59VQEX25T00	59VQEX25T01	59VQEX25T02	59VQEX25T03	59VQEX25T04	59VQEX25T05	59VQEX25T06	59VQEX25T07
59VQEX30T	15g	3.0GOU	Sinking - 3 s/m	59VQEX30T00	59VQEX30T01	59VQEX30T02	59VQEX30T03	59VQEX30T04	59VQEX30T05	59VQEX30T06	59VQEX30T07
59VQEX35U	19g	3.5GOU	Sinking - 3.5 s/m	59VQEX35U00	59VQEX35U01	59VQEX35U02	59VQEX35U03	59VQEX35U04	59VQEX35U05	59VQEX35U06	59VQEX35U07
		GOU		009	010	011	012	013	014	015	016
59VQEX25T	10g	2.5GOU	Sinking - 4 s/m	59VQEX25T08	59VQEX25T009	59VQEX25T0A	59VQEX25T0B	59VQEX25T0C	59VQEX25T0D	59VQEX25T0E	59VQEX25T0F
59VQEX30T	15g	3.0GOU	Sinking - 3 s/m	59VQEX30T08	59VQEX30T009	59VQEX30T0A	59VQEX30T0B	59VQEX30T0C	59VQEX30T0D	59VQEX30T0E	59VQEX30T0F
59VQEX35U	19g	3.5GOU	Sinking - 3.5 s/m	59VQEX35U08	59VQEX35U009	59VQEX35U0A	59VQEX35U0B	59VQEX35U0C	59VQEX35U0D	59VQEX35U0E	59VQEX35U0F



NEW

## Sephia Fuwafuwa Sutte S

- Versatile squid lure with high performance aggressive jigging action
- High buoyancy body does not absorb water and retains consistent action
- Can be fished at many depths and in a wide range of currents
- Ultra sharp stainless steel hooks



		GOU		001	002	003	004	005	006	007
59VQSQ01V	75mm	-	Floating	59VQSQ01V00	59VQSQ01V01	59VQSQ01V02	59VQSQ01V03	59VQSQ01V04	59VQSQ01V05	59VQSQ01V06
		GOU		008	009	010	011	012	013	014
59VQSQ01V	75mm	-	Floating	59VQSQ01V07	59VQSQ01V08	59VQSQ01V09	59VQSQ01V0A	59VQSQ01V0B	59VQSQ01V0C	59VQSQ01V00



FLASH BOOST

NEW

## Sephia Suisui Dropper FLASH BOOST

- Slow sinking with balanced horizontal profile
- FLASH BOOST technology for increased light reflecting attraction
- UV glow areas for additional attraction at night and in deep water
- Ultra sharp stainless steel hooks



		GOU		001	002	003	004	005	006	007	008	009	010
59VQSX25U	6.5g	2.5GOU	Slow Sinking	59VQSX25U00	59VQSX25U01	59VQSX25U02	59VQSX25U03	59VQSX25U04	59VQSX25U05	59VQSX25U06	59VQSX25U07	59VQSX25U08	59VQSX25U09



## ISOLATE BAIT

There are two ranges in the SHIMANO carp bait collection - ISOLATE and TX1. ISOLATE combines the finest quality ingredients, selected for their nutritional profile, easy digestibility and long term attraction. Proven ingredients, blended to unique ISOLATE formulas, deliver multiple layers of attraction and feeding stimulation. Boilies, pop-ups, wafers, liquids and glugs, as well as pellets are available for maximum feeding versatility.

The TX1 bait range offers fantastic value and is perfect for the casual carp fisherman. Packed with quality ingredients and enhanced flavourings to promote quick bites, the range comprises boilies, pop-ups, liquids and glugs.





#### ISOLATE

326 LM94 LIVER BOILIES  
RN20 RED BOILIES

327 PELLETS  
LM94 SYRUP · RN20 SYRUP  
LM94 GLUG · RN20 GLUG

#### TX1

328 TX1 BOILIES  
329 TX1 POP UP  
TX1 GLUG · TX1 SYRUP



# ISOLATE HOOKBAIT / BOILIES



## ISOLATE LM94 BOILIES

- LM94 is a complex fishmeal based boilie containing LT94 fishmeal, hydrolysed krill, digested liver, liver powder, N-butyric acid, vegetable protein and a powerful blend of seeds and minerals
- LT94 is a low temperature fishmeal recognised for its premium quality
- Hydrolysed krill is a known carp attractor, high in crude protein, Omega-3 fatty acids and vitamins
- Digested liver is high in vitamin 12 and amino acids, it adds to the nutritional value and to the flavour
- N-Butyric acid, a known carp attractor which is naturally organic with a pungent smell
- Available in three sizes in both 1kg and 3kg bags



Weight	Product Code	Size
1KG	ISOLM94B101000	10mm
	ISOLM94B151000	15mm
	ISOLM94B181000	18mm
	ISOLM94B201000	20mm
3KG	ISOLM94B153000	15mm
	ISOLM94B183000	18mm
	ISOLM94B203000	20mm

### Ingredients

Corn, Lt94 Fishmeal, Wheat, Full Fat Toasted Soy, Egg Powder, Spices Mix, Birdfood Seeds, Liver Powder, Hydrolysed Animal By-Products, Vegetable Protein Extract, Minerals, Preservatives



## ISOLATE RN20 BOILIES

- RN20 is a nut based boilie containing tigernut flour, crushed toasted soya beans, betaine HCL, kelp, spirulina and a wide range of additional proven fish-catching ingredients
- Spirulina is a nutrient-dense food packed full of vitamins, known for lowering stress levels, resulting in a more relaxed state when feeding
- Toasted peanut adds smell and taste attraction
- Tigernut flour, a high energy additive widely known as a top carp bait
- Oyster shell adds texture and a slight 'crunch' mimicking objects that carp pick up off the bottom when feeding
- Available in three sizes in both 1kg and 3kg bags



Weight	Product Code	Size
1KG	ISORN20B101000	10mm
	ISORN20B151000	15mm
	ISORN20B181000	18mm
	ISORN20B201000	20mm
3KG	ISORN20B153000	15mm
	ISORN20B183000	18mm
	ISORN20B203000	20mm

### Ingredients

Chickenmeal, Egg Powder, Corngrits, Crushed Toasted Soybeans, Extruded Cornflour, Tigernut Flour, Toasted Peanut Meal, Kelp, Chia Seeds, Rape Seeds, Niger Seeds, Oyster Shells, Yeast, Spray Dried Chickenmeal, Betain, Spirulina, Preservative



## ISOLATE PELLETS

- High quality pellets with excellent nutritional profile
- Pellets are a convenient choice for anglers who like to keep prepared feed with them at all times
- Ideal for creating a bed of feed, for mixing with other feeds or for use in a PVA bag set-up
- Available in 900g bags in 6 different sizes, ranging from 2mm - 16mm
- 12mm and 16mm pellets come pre-drilled

ISOHPPL02900  
 ISOHPPL04900  
 ISOHPPL06900  
 ISOHPPL08900  
 ISOHPPL12900  
 ISOHPPL16900

	kg
2mm	900g
4mm	900g
6mm	900g
8mm	900g
12mm	900g
16mm	900g

### Ingredients

Fishmeal, Soy flour, Hemoglobin, Feathermeal, Fish Oil, Poultry Oil, Flavouring, Additives: Antioxidants



## ISOLATE SYRUP & GLUG

- Liquids derived from the boilie recipe are key to complement your baiting
- Food Syrup and Hookbait Glug can be used to increase hookbait and feed attraction
- The LM94 & RN20 Hookbait Glug comes in a 200ml bottle
- The LM94 & RN20 Food Syrup comes in a 500ml bottle

LM94  
 ISOLM94LA500  
 ISOLM94HB250  
 RN20  
 ISORN20LA500  
 ISORN20HB250

Syrup	500ml
Glug	200ml
Syrup	500ml
Glug	200ml

### Ingredients

#### LM94 Food Syrup

Glycerin, Hydrolysed Fish Protein, Lt94 Fishmeal, Spices, Birdfood Seeds, Liver Powder, Hydrolysed Animal By Products, Aroma, Preservatives

#### LM94 Hookbait Glug

Glycerin, Lt94 Fishmeal, Spices, Birdfood Seeds, Liver Powder, Hydrolysed Animal By-Products

#### RN20 Food Syrup & Hookbait Glug

Glycerin, Poultry Protein, Tigernut Flour, Toasted Peanut Meal, Kelp, Milled Seeds, Yeast, Betain, Spirulina, Preservatives

# TX1 BOILIES / HARDBAIT / LIQUID



TX1



## Ingredients

### Tiger Nut

Corn, Wheat, Soy Flour, Vegetable Protein Extract, Seeds, Nut Meal, Lecithin, Minerals. Additives: Flavourings, Preservatives.

### Squid & Octopus

Corn, Wheat, Soy Flour, Vegetable Protein Extract, Milled Seeds, Crushed Halibut Pellets, Lecithin, Minerals. Additives: Colourant, Flavourings, Preservatives.

### Banana & Pineapple

Corn, Wheat, Soy Flour, Vegetable Protein Extract, Milled Seeds, Lecithin, Minerals. Additives: Colourant, Flavourings, Preservatives.

### Strawberry

Corn, Wheat, Soy Flour, Vegetable Protein Extract, Milled Seeds, Lecithin, Minerals. Additives: Colourant, Flavourings, Preservatives.

## TX1 BOILIES

- Packed with quality ingredients and enhanced flavourings to promote quick bites
- The simple, good quality base mix produces an open texture resulting in a high flavour leakage
- Available in 4 popular flavours
- Perfect for day ticket fisheries
- Excellent value for money
- Available in 15mm and 20mm, 1kg and 5kg bags

### 15MM 1KG

TX1TNB151000

TX1SOB151000

TX1BPB151000

TX1SBB151000

### 15MM 5KG

TX1TNB155000

TX1SOB155000

TX1BPB155000

TX1SBB155000

Tiger Nut

Squid

Banana

Strawberry

Tiger Nut

Squid

Banana

Strawberry

### 20MM 1KG

TX1TNB201000

TX1SOB201000

TX1BPB201000

TX1SBB201000

### 20MM 5KG

TX1TNB205000

TX1SOB205000

TX1BPB205000

TX1SBB205000

Tiger Nut

Squid

Banana

Strawberry

Tiger Nut

Squid

Banana

Strawberry





## TX1 POP-UP

- Packed with quality ingredients and enhanced flavourings to promote quick bites
- Pop-up hookbaits give versatility to presentation
- Available in 4 popular flavours
- Available in 12mm and 15mm sizes, in 100g pots

12MM	
TX1TNPU12100	Tiger Nut
TX1SOPU12100	Squid
TX1BPPU12100	Banana
TX1SBPU12100	Strawberry
15MM	
TX1TNPU15100	Tiger Nut
TX1SOPU15100	Squid
TX1BPPU15100	Banana
TX1SBPU15100	Strawberry

### Ingredients

#### Tiger Nut

Corn, Wheat, Soy Flour, Vegetable Protein Extract, Seeds, Nut Meal, Lecithin, Minerals. Additives: Flavourings, Preservatives.



#### Squid & Octopus

Corn, Wheat, Soy Flour, Vegetable Protein Extract, Milled Seeds, Crushed Halibut Pellets, Lecithin, Minerals. Additives: Colourant, Flavourings, Preservatives.

#### Banana & Pineapple

Corn, Wheat, Soy Flour, Vegetable Protein Extract, Milled Seeds, Lecithin, Minerals. Additives: Colourant, Flavourings, Preservatives.

#### Strawberry

Corn, Wheat, Soy Flour, Vegetable Protein Extract, Milled Seeds, Lecithin, Minerals. Additives: Colourant, Flavourings, Preservatives.



## TX1 GLUG & FOOD SYRUP

- Packed with quality ingredients and enhanced flavourings to promote quick bites
- The Glugs and Food Syrup can be used to increase hookbait and feed attraction
- Available in 4 popular flavours
- Food Syrup available in 500ml bottles
- Hookbait Glug comes in smaller 200ml bottles

GLUG	
TX1TNHB250	Tiger Nut
TX1SOHB250	Squid
TX1BPHB250	Banana
TX1SBHB250	Strawberry
SYRUP	
TX1TNLA500	Tiger Nut
TX1SOLA500	Squid
TX1BPLA500	Banana
TX1SBLA500	Strawberry

### Ingredients

#### Tiger Nut

Glycerine, Yeast, 1% Tiger Nut

#### Squid & Octopus

Glycerine, Robin Red (Haiths), Minerals, 1% Squid & Octopus Aroma

#### Banana & Pineapple

Glycerin, 1% Banana Aroma, 1% pineapple Aroma, EU Approved Colourants

#### Strawberry

Glycerin, 1% Strawberry Aroma, EU Approved Colourants

SHIMANO



# SHIMANO

 SHIMANO-Fishing       @SHIMANOfishing\_eu       FishWithSHIMANOEU



# SHIMANO PREDATOR

 SHIMANO-Predator       @SHIMANO\_Predator       SHIMANOPredatorEU

# TRIBAL

SHIMANO



SHIMANO-Tribal



@SHIMANO\_Tribal



SHIMANOTribalEU

# SHIMANO

# AERO



SHIMANO-Aero



@SHIMANO\_Aero



FishWithSHIMANOEU

---

**SHIMANO EUROPE B.V.**

High Tech Campus 92, 5656 AG Eindhoven, The Netherlands  
Tel. +31 (0)40 2612222

**SHIMANO BENELUX B.V.**

Industrieweg 24, 8071 CT Nunspeet, The Netherlands  
Tel. +31 (0)341 272233

**SHIMANO FRANCE S.A.S.**

Zone Actiparc - 777 Allée Commios, 62052 Saint Laurent Blangy, France  
Tél. 03.21.73.25.25 · E-mail: contact-france@shimano-eu.com

**SHIMANO GERMANY FISHING GMBH**

Dießemer Bruch 114f, 47805 Krefeld, Germany  
Tel. +49 (0)2151 55670 · Fax +49 (0)2151 5567-50

**SHIMANO IBERIA, SL**

Avenida Doctor Severo Ochoa 34, 28100, Alcobendas (Madrid), Spain  
Tel. +39 19022586

**SHIMANO ITALY FISHING S.R.L.**

S.S. Sempione 197, Pero (MI) 20016, Italy  
Tel. +39 (0)238 592 095

**SHIMANO NORDIC FISHING**

Edsbrogatan 1F, SE-752 28 Uppsala, Sweden  
Tel. +46 (0)18 56 16 00

**SHIMANO POLSKA SP. Z O.O.**

ul. Jana Gutenberga 9, Żerniki k/Poznania, 62-023 Gądko  
E-mail: spofishing@shimano-eu.com

**SHIMANO TURKEY FISHING**

Shimano Balik Malzemeleri A.S. Eski T. Ozal cd. 17/601 Basaksehir, 34406, Istanbul, Turkey  
Tel. +90 212 659 8152 · Fax +90 212 659 8247

**SHIMANO UK FISHING**

Unit 2, Elm Court, Copse Drive, Meriden Business Park, Coventry. CV5 9RG  
Tel. +44 (0)330 333 4888

**SHIMANO INC.**

3-77 Oimatsu-cho, Sakai Osaka, 590-8577 Japan  
Tel. +81 (0)722233467

---



**Follow us on Facebook**  
Shimano-Fishing  
Shimano-Predator  
Shimano-Tribal  
Shimano-Aero



**Follow us on Instagram**  
@fish\_shimano  
@shimano\_predator  
@shimano\_tribal  
@shimano\_aero



**See us on YouTube**  
[www.youtube.com/FishWithShimanoEU](http://www.youtube.com/FishWithShimanoEU)  
[www.youtube.com/ShimanoTribalEU](http://www.youtube.com/ShimanoTribalEU)  
[www.youtube.com/ShimanoPredatorEU](http://www.youtube.com/ShimanoPredatorEU)



**Shimano Europe**  
is a proud  
member of  
EFTTA

© Shimano 2022 - Pat. & Pat Pending  
Lengths and specifications are approximate and may change without prior notice. E. & O.E.

**SHIMANO**

