

CATALOG 2022



Lucky  
John®

**NOREIN**®  
ULTIMATE PROTECTION

**FEEDER  
CONCEPT**

*Cobra*

# SUMMER . . . . . 4



4

REELS . . . . .	4
RODS . . . . .	8
LINES . . . . .	38
LANDING NETS AND ACCESSORIES . . . . .	40
SOFT LURES. . . . .	44
WOBLERS . . . . .	62
METAL LURES. . . . .	68
JIGHEADS, JIG BALLS . . . . .	82
HOOKS. . . . .	86
TERMINAL TACKLE . . . . .	88
TACKLE BAGS . . . . .	94



116

COBRA HOOKS . . . . .	116
-----------------------	-----



122

SUITS AND JACKETS . . . . .	122
PANTS AND SHIRTS. . . . .	135
HATS AND GLOVES . . . . .	137
BOOTS AND WADERS. . . . .	138
LIFE VESTS . . . . .	144
SUNGLASSES . . . . .	145
NORFIN OUTDOOR . . . . .	148
PREMIUM FISHING COLLECTION . . . . .	149
TENTS, SLEEPING BAGS . . . . .	150
BACKPACKS. . . . .	156
THERMAL BAGS. . . . .	161
CAMPING FURNITURE . . . . .	162



99

REELS . . . . .	100
RODS . . . . .	102
LINES . . . . .	107
FEEDERS . . . . .	108
ACCESSORIES. . . . .	110



# WINTER . . . . . 165



165

- ICE FISHING RODS . . . . . 165
- REELS . . . . . 171
- SEAT BOX, LURE CASES . . . . . 173
- LINES . . . . . 174
- BALANCED LURES . . . . . 177
- VERTICAL LURES AND TREBLES . . . . . 180
- SOFT LURES . . . . . 183



184

- SUITS AND JACKETS . . . . . 188
- UNDERWEAR . . . . . 202
- NORFIN WARMERS . . . . . 205
- HATS AND MASKS . . . . . 206
- GLOVES . . . . . 208
- SOCKS . . . . . 210
- BOOTS . . . . . 214
- WOMEN . . . . . 216
- ICE DRILLS . . . . . 218



## Marketing Materials

220

- BASEBALL CAPS
- ROD STANDS
- ACCESSORIES
- FLAGS AND STICKERS

**NEW**

# HOT NEWS 2022



**BLACK SENSE BBS  
JERK&TWITCH 150**  
19. P.

**BBS**  
BIG BAIT SERIES



**VANREX  
SPIN 5**  
7. P.



**VANREX  
SPIN 6**  
7. P.



**VANREX  
EGI&JIGGING**  
38. P.



**KUBIRA FIRE TAIL**  
44. P.



**FREDDY FROG**  
50. P.



**ARROW JERK 150**  
69. P.



**BASARA TAIL SPIN**  
74. P.



**FEXHEAD PIKE**  
83. P.



**BAG FOR SAFE WEIGHING OF  
TROPHY FISH**  
98. P.





**FEEDER CONCEPT**

**FEEDER CONCEPT  
TURNAMENT II 7  
100. P.**



**FEEDER CONCEPT STORM  
133. P.**



**FEEDER CONCEPT CLAW  
108. P.**



**CHAIR FEEDER CONCEPT  
COMPAT  
115. P.**



**\*  
NOREIN®  
ULTIMATE PROTECTION**

**ALPHA  
139. P.**



**KLONDAIK 2  
214. P.**



**PILOT  
BOOTFOOT  
140. P.**



**MIRAGE  
130. P.**



**THUNDER  
131. P.**



## LUCKY JOHN TECHNICAL SOLUTIONS AND CHARACTERISTICS OF REELS

	A mechanical braking system	The simplest spool braking system when casting a lure.
	Magnetic drag system	With this drag system you can adjust your reel drag in very sensitive mode.
	Bearings	The ball bearings are made with high precision. They ensure the smooth rotation of the reel mechanism and assemblies. Roller bearings withstand higher loads than ball bearings, they are installed in the most important and most loaded assemblies of the reel mechanism. They ensure the operability of the reel anti-reverse mechanism. Both ball and roller bearings significantly increase the reel's operation life.
	Ball bearings	The ball bearings are made with high precision. They ensure the smooth rotation of the reel mechanism and assemblies; they also increase the reel's operation life.
	Reinforced, stainless steel ball bearings	The bearings are designed for increased loads. They have an increased operational life. Bearing material is not subject to corrosion.
	Gear ratio	The gear ratio is one of the main technical characteristics of the reels and indicates the number of rotations of the spool made per turn of the reel handle. The higher the gear ratio, the higher the speed of the winding, and, accordingly, the lower the gear ratio, the lower the winding speed.
	Instant anti-reverse (IAR)	A special mechanism of the overrunning (backstop) clutch that prevents the minimum reverse rotation of the reel rotor. This eliminates all impact loads on the mechanism while playing the fish.
	Graphite body	This reel body is made of special, durable plastic (graphite).
	Main aluminium spool (lightweight)	The spool is made of aluminium alloys (with special holes in the body that make it lightweight).
	Main graphite spool	The spool is made of special, durable graphite.
	Spare aluminium spool	The spare spool is made of aluminium alloys (with special holes in its body to make it lightweight).
	Spare graphite spool	The spare spool is made of special, durable graphite.
	Big line roller, extended (anti-twist)	The increased conical roller prevents the fishing line from twisting and ensures a more reliable, and non-slip passing of the fishing line through the roller when winding the line.
	Hollow bail wire (lightweight)	The lightweight bail of the fishing line laying mechanism. The bail has a hollow shape and is made of stainless steel.
	Wear-resistant titanium nitride coating	A modern and the most wear-resistant coating applied to the main material of the reel parts. It ensures maximum longevity for friction surfaces.
	Aluminium handle, machined	The reel handle is made by means of building the blank from durable aluminium alloys.

## LUCKY JOHN MULTIPLIER REEL **BLACK SENSE ULTIMAX 10**

- Mechanic Drag
- Magnetic Drag
- Star drag
- 9 stainless steel ball bearings
- 1 stainless steel roller bearing
- Instant anti-reverse
- Reel body – high durability light weight plastic
- Spool – shallow aluminium
- Line roller with worm shaft

- Handle:
- Left
  - Aluminum
  - Balanced
  - Ergonomic EVA handle knobs



ITEM NO.	SIZE	BB	RB	M/MM	WEIGHT (G)	GEAR RATIO	SPOOL	SPARE SPOOL
LJBSU10-MLC	30	9	1	PE 150/0,12	159	6,5 : 1	Al	-

## LUCKY JOHN BAITCASTING REEL

### LUCKY JOHN MULTIPLIER REEL **VANREX CAST 6**

«High quality low profile baitcasting reel with left hand handle placement. Reel has two drag systems: 10 position Magnetic for very fine drag adjustment and Mechanic drag system. Reel is equipped with high quality stainless ball bearings.

- 5 ball bearings
- 1 roller bearing
- Instant anti-reverse
- Reel body and rotor made from high durability plastic
- Spool – shallow aluminium
- Magnetic and mechanic drag systems

- Handle:
- Left hand placement
  - Ergonomic rubber knob»



ITEM NO.	SIZE	BB	RB	M/MM	WEIGHT (G)	GEAR RATIO
LJ-6030BC	30	5	1	140/0,35	210	6,2:1

### LUCKY JOHN MULTIPLIER REEL **VANREX CAST 6 ML**

- Mechanic Drag
- Magnetic Drag
- Star drag
- 5 ball bearings
- 1 roller bearing
- Instant anti-reverse
- Reel body – high durability plastic
- Spool –aluminum
- Line roller with worm shaft

- Handle:
- Left
  - Aluminum
  - Balanced
  - Ergonomic plastic handle knobs



ITEM NO.	SIZE	BB	RB	M/MM	WEIGHT (G)	GEAR RATIO	SPOOL	SPARE SPOOL
LJVC06-MLC	30	5	1	140/0,26	194	6,3 : 1	Al	-

## LUCKY JOHN SPINNING REEL ANIRA SERIES

### SPINNING REEL ANIRA JIG 8

Reel developed for jig technique. Great combination of price/quality.

- Front drag FD
- 7 ball bearings
- 1 roller bearing
- Instant anti-reverse
- Reel body and rotor made from high durability plastic
- Main spool - shallow aluminium
- Spare spool - shallow aluminium
- Lightweight, hollow bail arm
- Big line roller extended (anti-twist)

**Handle:**

- "Screw in" type
- Possibility of right/left placement
- Ergonomic rubber knob

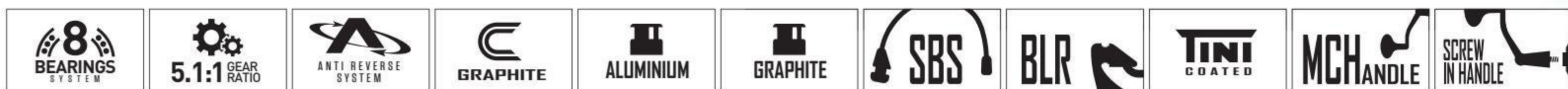
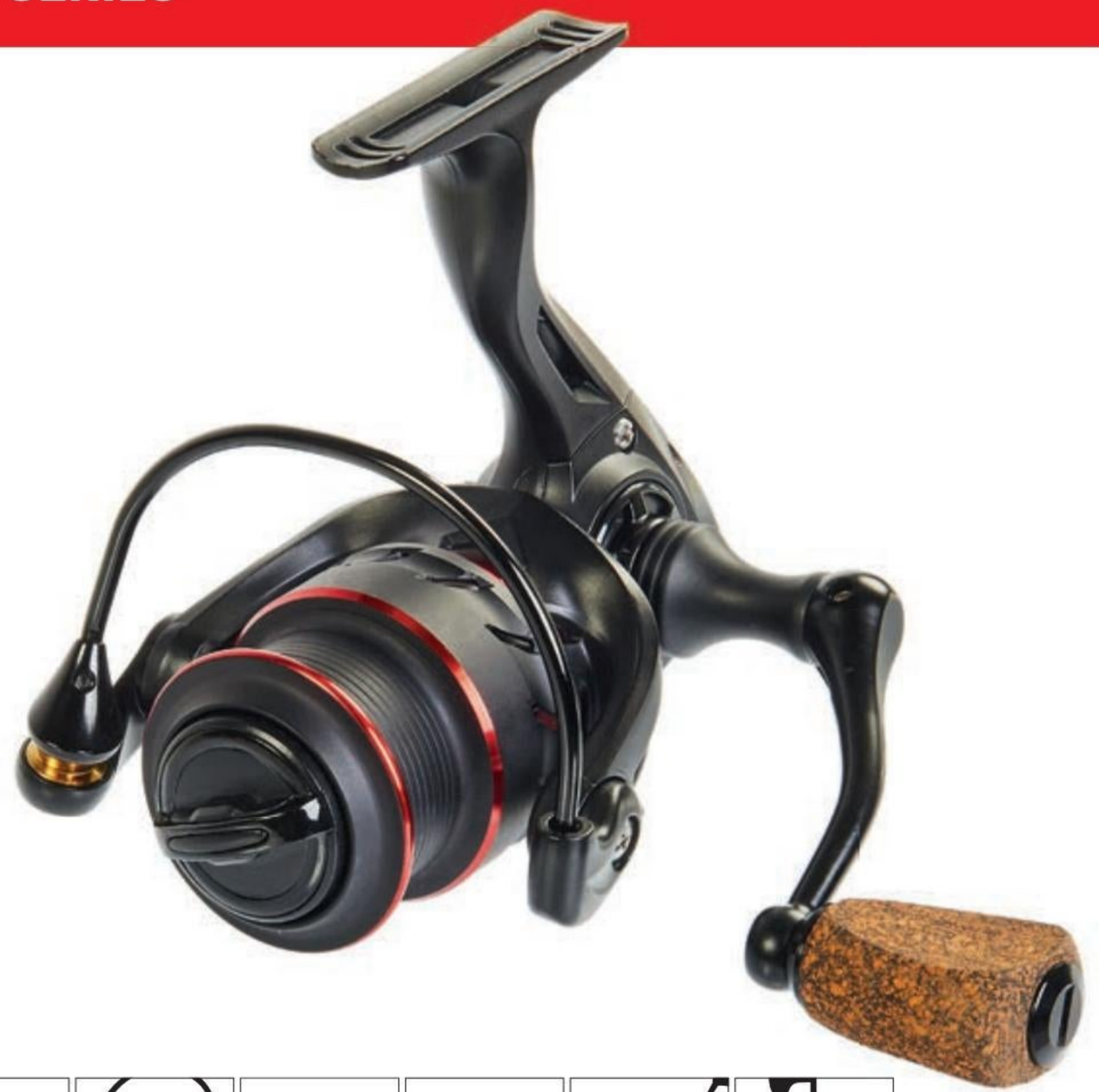

ITEM NO.	SIZE	BB	RB	M/MM	WEIGHT (G)	GEAR RATIO	SPOOL	SPARE SPOOL
LJ-8115FD	1500	7	1	120/0,220	245	5,1:1	1Al	1Al
LJ-8125FD	2500	7	1	135/0,240	277	5,1:1	1Al	1Al
LJ-8135FD	3500	7	1	115/0,280	295	5,1:1	1Al	1Al
LJ-8145FD	4500	7	1	140/0,330	317	5,1:1	1Al	1Al

## LUCKY JOHN SPINNING REEL VANREX SERIES

### SPINNING REEL VANREX BP 7

- Front drag FD
- 6 ball bearings
- 1 roller bearing
- Instant anti-reverse
- Reel body and rotor - high durability plastic
- Spool - shallow aluminum
- Lightweight, hollow bail arm
- Big line roller extended (anti-twist)

**Handle:**

- "Screw in" type
- Possibility of right/left placement
- Ergonomic EVA handle knob



ITEM NO.	SIZE	BB	RB	M/MM	WEIGHT (G)	GEAR RATIO	SPOOL	SPARE SPOOL
LJ-1130FD	3000	6	1	155/0,28	255	5,2 : 1	Al	-



## SPINNING REEL VANREX SPIN 5

NEW

- Front drag FD
- 4 ball bearings
- 1 roller bearing
- Instant anti-reverse
- Reel body and rotor - high durability plastic
- Spool - shallow aluminium
- Big line roller extended (anti-twist)

**Handle:**

- Aluminium CNC
- "Screw in" type
- Possibility of right/left placement
- Ergonomic rubber knob



ITEM NO.	SERIES	MODEL	SIZE	DRAG	BB	RB	M/MM	WEIGHT (G)	GEAR RATIO	SPOOL	SPARE SPOOL
LJVS05-20FD	Vanrex	Spin 5	2000	FD	4	1	135/0,200	255	5,1 : 1	1Al	-
LJVS05-30FD	Vanrex	Spin 5	3000	FD	4	1	185/0,200	258	5,1 : 1	1Al	-

## SPINNING REEL VANREX SPIN 6

NEW

- Front drag FD
- 5 ball bearings
- 1 roller bearing
- Instant anti-reverse
- Reel body and rotor - high durability plastic
- Spool - shallow aluminium
- Big line roller extended (anti-twist)

**Handle:**

- Aluminium CNC
- "Screw in" type
- Ergonomic rubber knob



ITEM NO.	SERIES	MODEL	SIZE	DRAG	BB	RB	M/MM	WEIGHT (G)	GEAR RATIO	SPOOL	SPARE SPOOL
LJVS06-20FD	Vanrex	Spin 6	2000	FD	5	1	160/0,205		5,1 : 1	1Al	-
LJVS06-30FD	Vanrex	Spin 6	3000	FD	5	1	171/0,235		5,1 : 1	1Al	-

## LUCKY JOHN TECHNICAL SOLUTIONS AND CHARACTERISTICS OF RODS

### BLANK MATERIAL

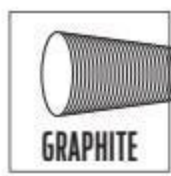

The blank material of the fishing rod is carbon fibre

The fishing rod blank is made of carbon fibre. Carbon fibre is very durable; because of this, fishing rod walls are made very thin and the fishing rod has a minimal weight and high sensitivity.

### ACTION TYPE

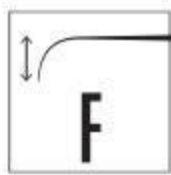

Blank action type – composite

The upper 1/3 of the blank bends when being loaded.



Blank action type – medium-composite

The blank bends between the upper 1/3 and 1/2 when being loaded.

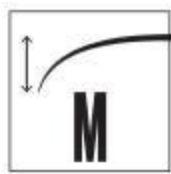

Blank action type – medium

The upper part of the blank bends when being loaded.

### CLASS



UL spinning rod class

Spin fishing rods designed for casting lures weighing up to 5 grams.



L spinning rod class

Spin fishing rods designed for casting lures weighing from 3 to 15 grams.



ML spinning rod class

Spin fishing rods designed for casting lures weighing from 5 to 20 grams.



M spinning rod class

Spin fishing rods designed for casting lures weighing from 7 to 30 grams.



MH spinning rod class

Spin fishing rods designed for casting lures weighing from 10 to 45 grams.

### FISHING ROD CONNECTIONS



In Steek connection

Fishing rod pieces are connected by fitting the upper piece into the lower one.



Over Steek connection

Fishing rod pieces are connected by fitting the upper piece over the lower one.

### GUIDES



Guides with SIC inserts

The fishing rod guides have silicon carbide (SIC) inserts. These wear-resistant guides allow stranded cord to be used for.

### ARRANGEMENT OF GUIDES



Guides arranged according to a new concept

Arrangement of the fishing rod guides according to a new concept allows uniform load distribution on the upper blank part of the spinning rod to be achieved. Small diameter guides in the upper blank part used for this purpose do not disturb the dynamic features of the spinning rod. In this case, the number of Guides is greater than in the case of arrangement by traditional approach.

### HANDLE



Handle

The convenient shape of the cork handle lets you performing continuous manipulations with the fishing rod while fishing – Ergonomic cork without any discomfort for the angler's hands.

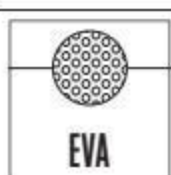

Neoprene ergonomic handle

The convenient shape of the neoprene handle lets you perform continuous manipulations with the fishing rod while fishing, without any discomfort for your hands.

### REEL SEAT



Screw-type reel seat

The reel is compositeed in the reel seat by the special locking nut, which has a lock that rotates along the line.

# LUCKY JOHN SPINNING RODS ONE SENSORIC SERIES

ITEM NO.	SERIES	MODEL	BLANK MATERIAL	ACTION	LENGTH (FT/M)	WEIGHT (G)	CASTING WEIGHT (G)	SECTIONS	TRANSP. LENGTH (CM)
LJOS-742LF	One Sensoric	LIGHT GAME 12	Carbon fiber	fast	7'4"/2,25	95	1,5-12	2	114
LJOSDE-742LF	One Sensoric	DELIKADO 12	Carbon fiber	fast	7,4/2,24	103	3-12	2	115
LJOSDE-802LF	One Sensoric	DELIKADO 12	Carbon fiber	fast	8,0/2,44	111	3-12	2	126
LJOSIN-702LMF	One Sensoric	INSPIRADO 09	Carbon fiber	medium fast	7,0/2,13	83	2-9	2	109
LJOSIN-762LMF	One Sensoric	INSPIRADO 09	Carbon fiber	medium fast	7,6/2,29	90	2-9	2	119
LJOSSS-9102MHEF	One Sensoric	SALMON STICK 42	Carbon fiber	extra fast	9,1/3,0	162	15-42	2	155
LJOSVA-702MLF	One Sensoric	VANTAGE 21	Carbon fiber	fast	7,0/2,13	108	6-21	2	110
LJOSVA-762MLF	One Sensoric	VANTAGE 21	Carbon fiber	fast	7,6/2,29	114	6-21	2	118
LJOSVA-702MF	One Sensoric	VANTAGE 28	Carbon fiber	fast	7,0/2,13	113	8-28	2	110
LJOSVA-762MF	One Sensoric	VANTAGE 28	Carbon fiber	fast	7,6/2,29	125	8-28	2	118
LJOSDS-7112MF	One Sensoric	DROPSHOT 35	Carbon fiber	fast	7'11"/2,40	133	10-35	2	124
LJOSDS-882MF	One Sensoric	DROPSHOT 35	Carbon fiber	fast	8'8"/2,64	160	10-35	2	136
LJOS-712ULMF	One Sensoric	SMALL GAME 5/6	Carbon fiber	medium fast	7,1/2,16	87	0,4-5	2	111,5
LJOS-762ULMF	One Sensoric	SMALL GAME 5/6	Carbon fiber	medium fast	7,6/2,28	91	0,5-6	2	118
LJOS-715ULF	One Sensoric	TRAVEL MATE 5	Carbon fiber	medium	7,1/2,16	82	1-5	5	48

**NEW**

## SPINNING ROD ONE SENSORIC LIGHT GAME 12

**BLANK:**

- Material - Toray carbon fiber (40T)
- Action - **fast F**
- Class - **light L**
- Joint type - **OVER STEEK**

**HANDLE:**

- Material - AAA grade cork
- Screw type reel seat

**GUIDES:**

- Anti tangle **FUJI KR**
- **SIC** inserts

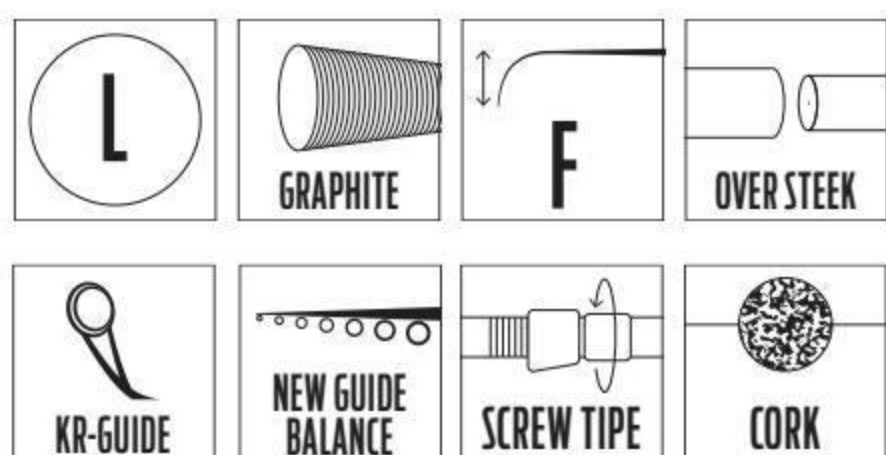
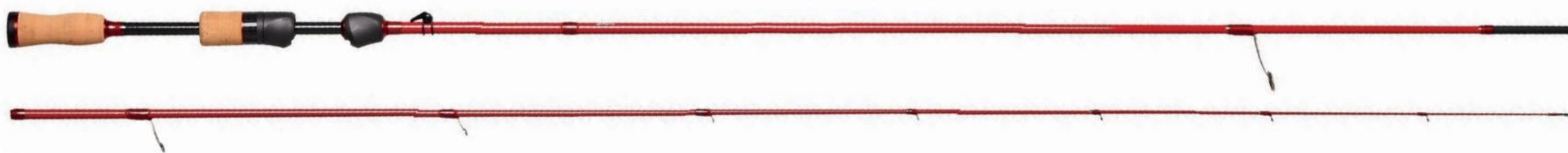

ITEM NO.	LENGTH (F/M)	WIGHT (G)	CLASS	ACTION	CASTING WIGHT (G)	SECTIONS	TRANSP.LENGTH (CM)
LJOS-742LF	7'4"/2,25	95	L	fast	1,5-12	2	114

## SPINNING ROD ONE SENSORIC DELIKADO 12

**BLANK:**

- Material - carbon fiber (40T)
- Action - **fast F**
- Class - **light L**
- Joint type - **OVER STEEK**

**HANDLE:**

- Material (hard) **EVA**
- Screw type **FUJI** reel seat

**GUIDES**

- Anti-tangle **FUJI**
- **SIC** inserts

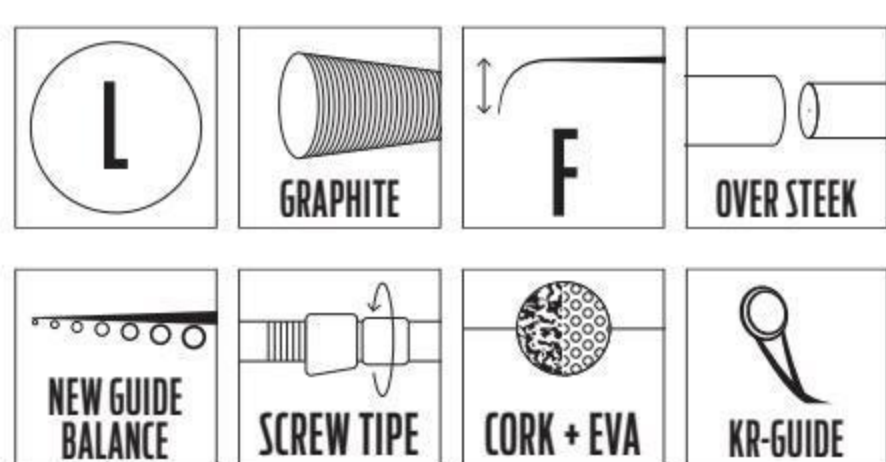
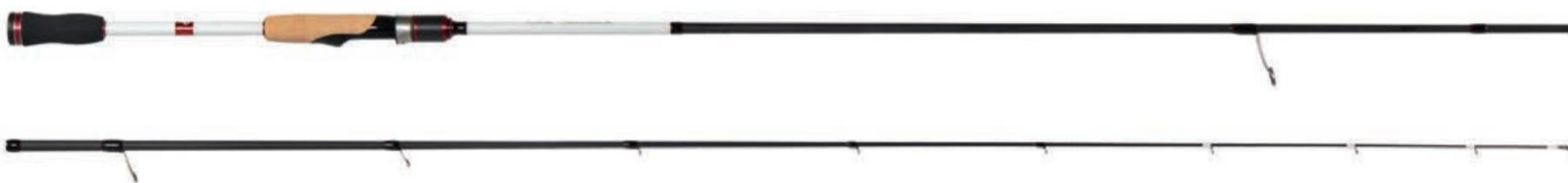

ITEM NO.	LENGTH (FT/M)	WEIGHT (G)	CLASS	ACTION	CASTING WEIGHT (G)	SECTIONS	TRANSP. LENGTH (CM)
LJOSDE-742LF	7,4/2,24	103	L	F	3-12	2	115
LJOSDE-802LF	8,0/2,44	111	L	F	3-12	2	126

## SPINNING ROD ONE SENSORIC **INSPIRADO 09**

### BLANK:

- Material - carbon fiber **(40T)**
- Action - **medium-fast MF**
- Class - **light L**
- Joint type - **OVER STEEK**

### HANDLE:

- Material (hard) **EVA**
- Screw type FUJI reel seat

### GUIDES

- Anti-tangle **FUJI**
- **SIC** inserts

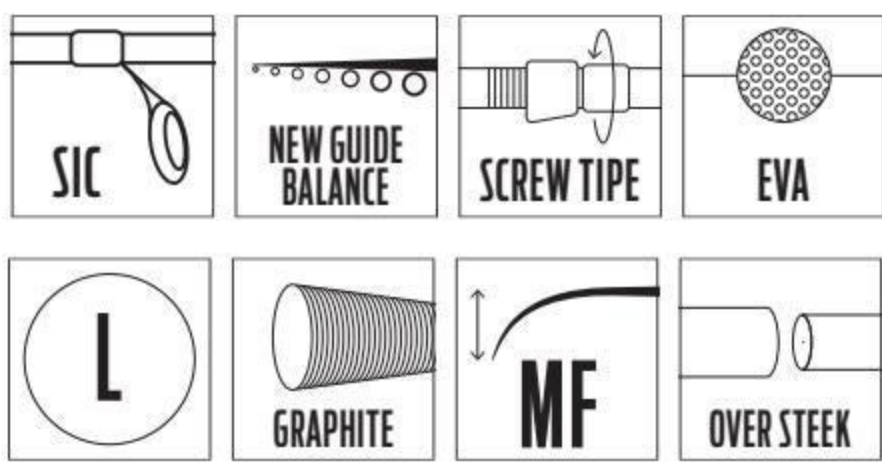
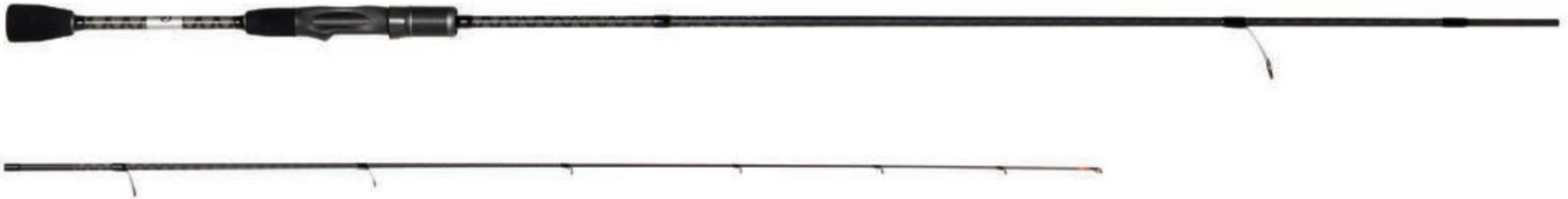

ITEM NO.	LENGTH (FT/M)	WEIGHT (G)	CLASS	ACTION	CASTING WEIGHT (G)	SECTIONS	TRANSP. LENGTH (CM)
LJOSIN-702LMF	7,0/2,13	83	L	MF	2-9	2	109
LJOSIN-762LMF	7,6/2,29	90	L	MF	2-9	2	119

## SPINNING ROD ONE SENSORIC **DROPSHOT 35**

**NEW**

Specific rod for DROPSHOT fishing

### BLANK:

- Material - carbon fibre **(40T)**
- Action - **fast F**
- Class - **medium M**
- plug-in design
- Joint type - **OVER STEEK**

### HANDLE:

- Material (hard) **EVA**
- Screw type reel seat

### GUIDES:

- Anti-tangle **K-GUIDE**
- **SIC** inserts

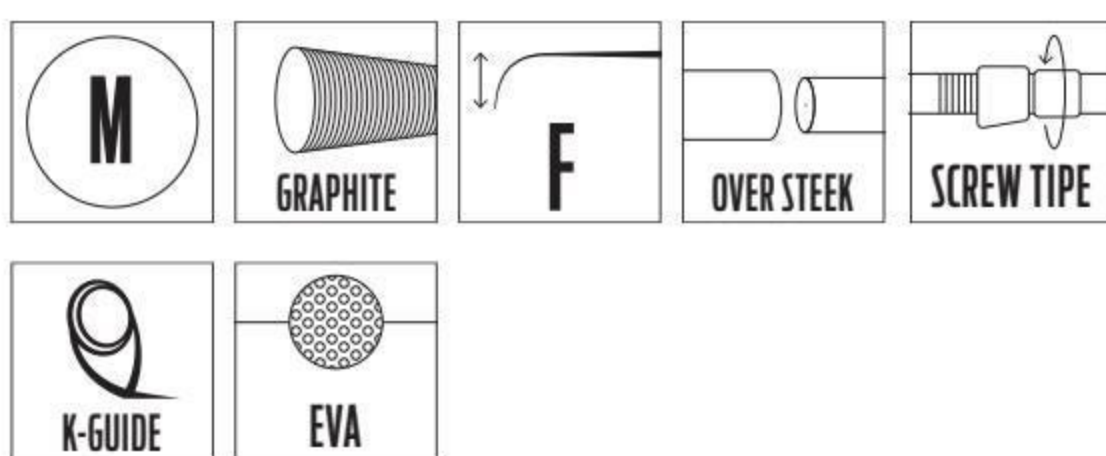
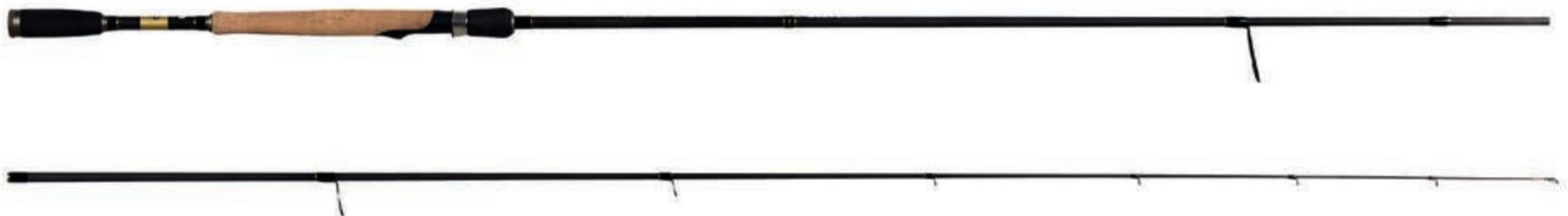

ITEM NO.	LENGTH (FT/M)	WEIGHT (G)	CLASS	ACTION	CASTING WEIGHT (G)	SECTIONS	TRANSP. LENGTH (CM)
LJOSDS-7112MF	7'11"/2,40	133	M	fast	10-35	2	124
LJOSDS-882MF	8'8"/2,64	160	M	fast	10-35	2	136

## SPINNING ROD ONE SENSORIC VANTAGE 21

### BLANK:

- Material – carbon fiber **(40T)**
- Action – **fast F**
- Class – **medium light ML**
- Joint type – **OVER STEEK**

### HANDLE:

- Combined – (hard) **EVA**, AAA grade cork
- Screw type **FUJI** reel seat

### GUIDES:

- Anti-tangle **KIGAN**
- **SIC** inserts

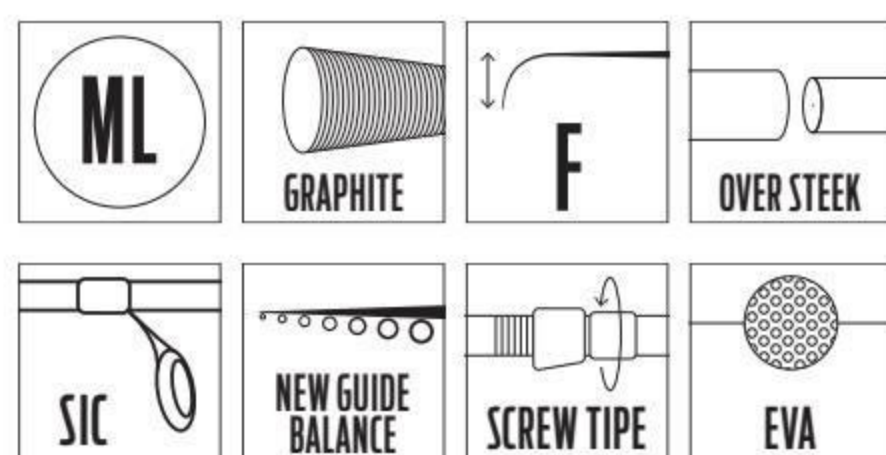

ITEM NO.	LENGTH (FT/M)	WEIGHT (G)	CLASS	ACTION	CASTING WEIGHT (G)	SECTIONS	TRANSP. LENGTH (CM)
LJOSVA-702MLF	7,0/2,13	108	ML	F	6-21	2	110
LJOSVA-762MLF	7,6/2,29	114	ML	F	6-21	2	118

## SPINNING ROD ONE SENSORIC VANTAGE 28

### BLANK:

- Material – carbon fibre **(40T)**
- Action – **fast F**
- Class – **medium M**
- Joint type – **OVER STEEK**

### HANDLE:

- Combined – (hard) **EVA**, AAA grade cork
- Screw type **FUJI** reel seat

### GUIDES:

- Anti-tangle **KIGAN**
- **SIC** inserts

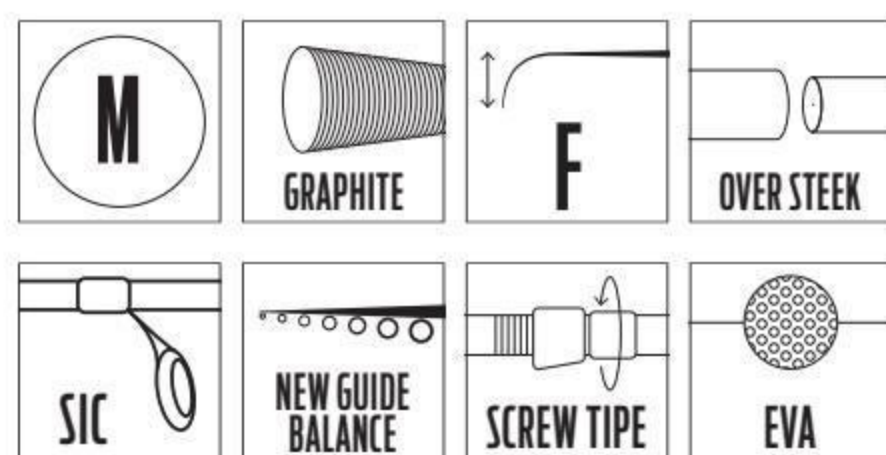

ITEM NO.	LENGTH (FT/M)	WEIGHT (G)	CLASS	ACTION	CASTING WEIGHT (G)	SECTIONS	TRANSP. LENGTH (CM)
LJOSVA-702MF	7,0/2,13	113	M	F	8-28	2	110
LJOSVA-762MF	7,6/2,29	125	M	F	8-28	2	118

## SPINNING ROD ONE SENSORIC **SALMON STICK 42**

### BLANK:

- Material - carbon fibre (40T)
- Action - **extra fast EF**
- Class - **medium heavy MH**
- Joint type - **OVER STEEK**

### HANDLE:

- Combined - (hard) **EVA**, AAA grade cork
- Screw type FUJI reel seat

### GUIDES:

- Anti-tangle
- **SIC** rings

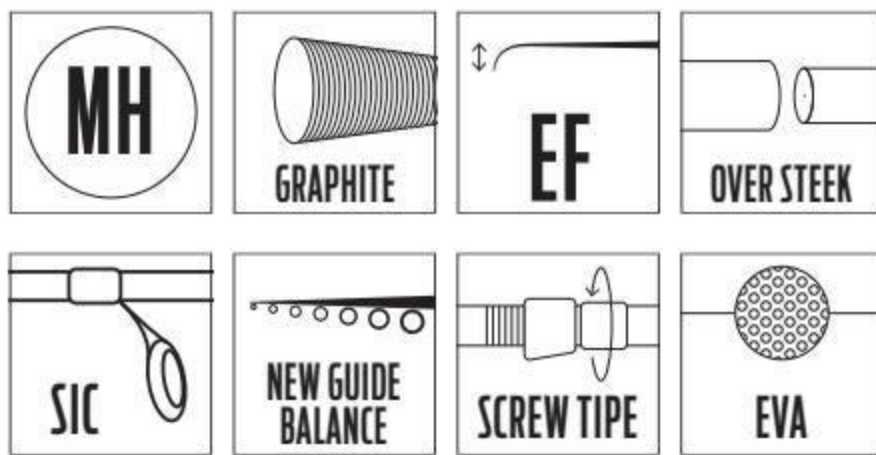
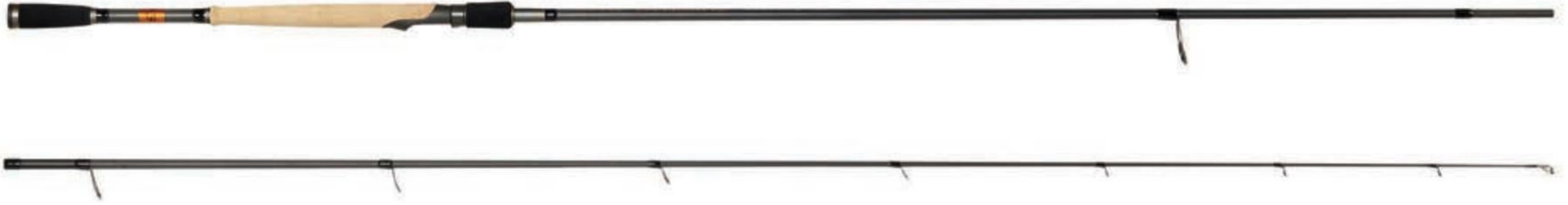

ITEM NO.	LENGTH (FT/M)	WEIGHT (G)	CLASS	ACTION	CASTING WEIGHT (G)	SECTIONS	TRANSP. LENGTH (CM)
LJOSS-9102MHEF	9,1/3,0	162	MH	EF	15-42	2	155

## SPINNING ROD ONE SENSORIC **SMALL GAME 5/6**

### BLANK:

- Material - carbon fibre (40T)
- Action - **medium fast MF**
- Class - **ultra light UL**
- Joint type - **OVER STEEK**

### HANDLE:

- Material - hard **EVA**
- Screw type **FUJI** reel seat

### GUIDES:

- Lightweight **FUJI TITANIUM**
- **SIC** inserts

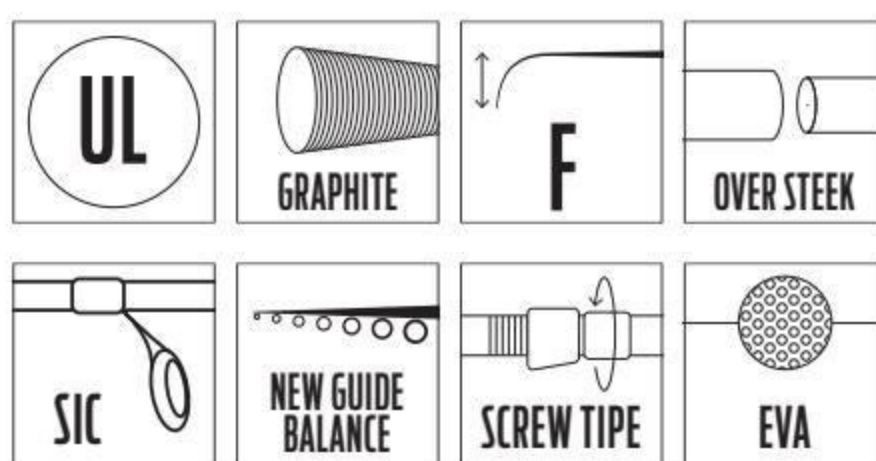

ITEM NO.	LENGTH (FT/M)	WEIGHT (G)	CLASS	ACTION	CASTING WEIGHT (G)	SECTIONS	TRANSP. LENGTH (CM)
LJOS-712ULMF	7,1/2,16	87	U-Light	Fast	0,4-5	2	111,5
LJOS-762ULMF	7,6/2,28	91	U-Light	Fast	0,5-6	2	118

## SPINNING ROD ONE SENSORIC TRAVEL MATE 5

Medium action 5 section high class spinning rod for travel.

### BLANK:

- Material – carbon fiber **(40T)**
- Action – **medium M**
- Class – **ultra light UL**
- Joint type – **OVER STEEK**

### HANDLE:

- Material – hard **EVA**
- Screw type **FUJI** reel seat

### GUIDES:

- Lightweight **FUJI TITANIUM**
- **SIC** inserts

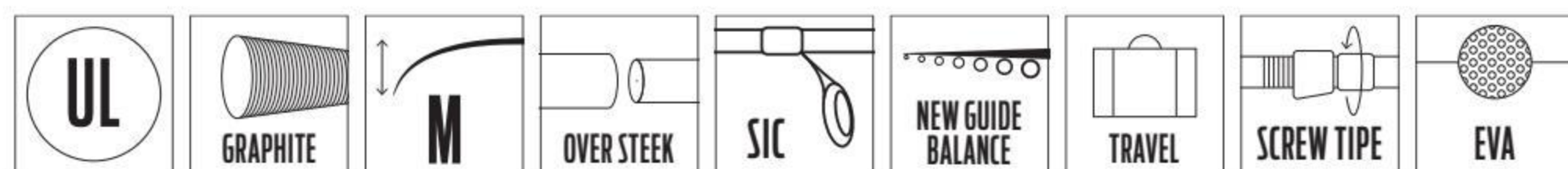

ITEM NO.	LENGTH (FT/M)	WEIGHT (G)	CLASS	ACTION	CASTING WEIGHT (G)	SECTIONS	TRANSP. LENGTH (CM)
LJOS-715ULF	7,1/2,16	82	U-Light	Medium	1-5	5	48



## LUCKY JOHN SPINNING RODS ANIRA SERIES

ITEM NO.	SERIES	MODEL	BLANK MATERIAL	ACTION	LENGTH (FT/M)	WEIGHT (G)	CASTING WEIGHT (G)	SECTIONS	TRANSP. LENGTH (CM)
LJAST-962MM	Anira	SEATROUT 25	Carbon fiber	medium	9,6/2,90	145	7-25	2	147
LJA-712LF	Anira	ANIRA 14	Carbon fiber	fast	7,1/2,16	92	4-14	2	112
LJA-762LMF	Anira	ANIRA 14	Carbon fiber	fast	7,6/2,29	98	4-14	2	119
LJA-712MLF	Anira	ANIRA 24	Carbon fiber	fast	7,1/2,16	93	5-24	2	112
LJA-762MLF	Anira	ANIRA 24	Carbon fiber	fast	7,6/2,29	104	5-24	2	119
LJA-802MLF	Anira	ANIRA 24	Carbon fiber	fast	8,0/2,44	110	5-24	2	126
LJA-712MF	Anira	ANIRA 34	Carbon fiber	fast	7,1/2,16	100	8-34	2	112
LJA-762MF	Anira	ANIRA 34	Carbon fiber	fast	7,6/2,29	106	8-34	2	119
LJA-822MF	Anira	ANIRA 34	Carbon fiber	fast	8,2/2,49	124	8-34	2	129
LJA-782MHEF	Anira	ANIRA 45	Carbon fiber	extra fast	7,8/2,34	123	12-45	2	121
LJA-822MHEF	Anira	ANIRA 45	Carbon fiber	extra fast	8,2/2,49	131	12-45	2	129
LJA-902MHEF	Anira	ANIRA 45	Carbon fiber	extra fast	9,0/2,74	161	12-45	2	142
LJA-822HEF	Anira	ANIRA 60	Carbon fiber	extra fast	8,2/2,49	145	15-60	2	129
LJA-902HEF	Anira	ANIRA 60	Carbon fiber	extra fast	9,0/2,74	176	15-60	2	142
LJASM-7112LM	Anira	STREAM 10	Carbon fiber	medium	7,11/2,4	102	3-10	2	126
LJASM-8102LM	Anira	STREAM 10	Carbon fiber	medium	8,1/2,7	117	3-10	2	140
LJASN-992MF	Anira	SALMON 35	Carbon fiber	fast	9,9/2,97	192	10-35	2	153
LJA-662ULF	Anira	MICROJIG 5	Carbon fiber	fast	6,6/1,98	87	0,7-5	2	104
LJA-712ULF	Anira	MICROJIG 5	Carbon fiber	fast	7,1/2,16	92	0,7-5	2	111
LJA-752ULF	Anira	MICROJIG 5	Carbon fiber	fast	7,5/2,26	96	0,7-5	2	118

### LUCKY JOHN ROD ANIRA SEATROUT 25

#### BLANK:

- Material - carbon fiber (40T)
- Action - **medium**
- Class - **medium**
- Joint type - **OVER STEEK**

#### HANDLE:

- Material AAA grade cork
- Screw type reel seat

#### GUIDES

- Anti-tangle
- **SIC** inserts

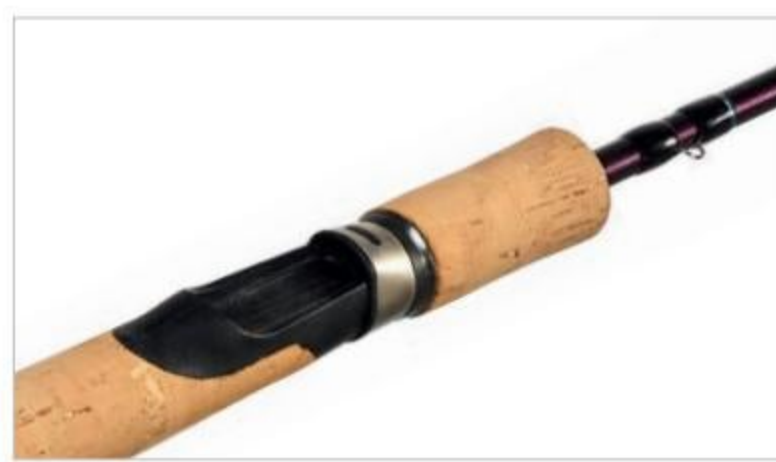
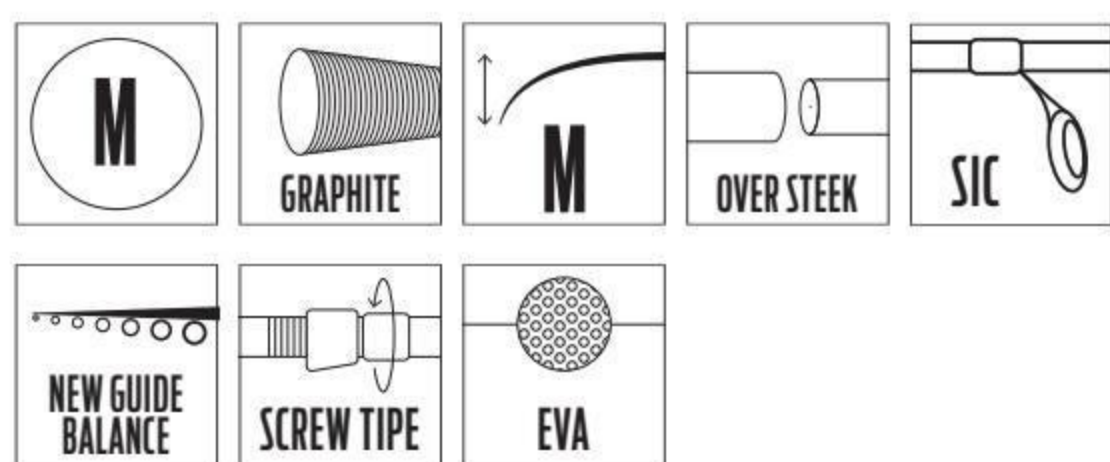

ITEM NO.	LENGTH (FT/M)	WEIGHT (G)	CLASS	ACTION	CASTING WEIGHT (G)	SECTIONS	TRANSP. LENGTH (CM)
LJAST-962MM	9,6/2,90	145	M	M	7-25	2	147

### SPINNING ROD ANIRA SALMON 35

#### BLANK:

- Material - carbon fibre (40T)
- Action - **fast F**
- Class - **medium M**
- Joint type - **OVER STEEK**

#### HANDLE:

- Combined - hard **EVA**, AAA grade cork
- Screw type reel seat

#### GUIDES:

- Anti-tangle
- **SIC** inserts

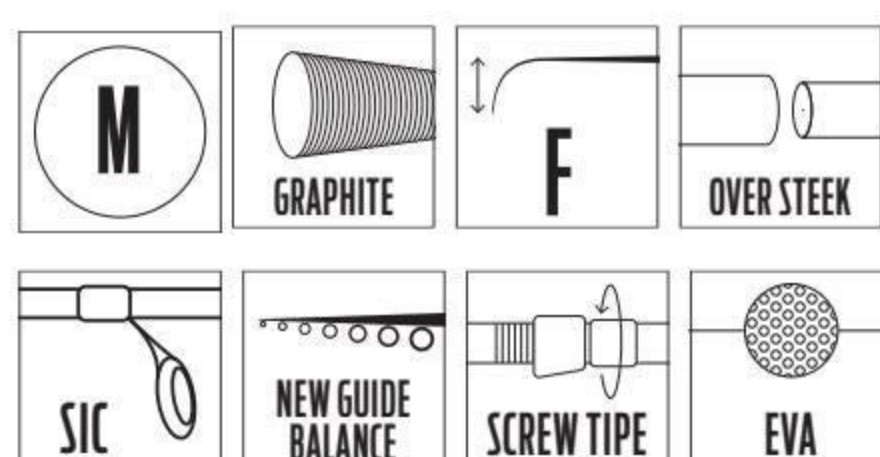

ITEM NO.	LENGTH (FT/M)	WEIGHT (G)	CLASS	ACTION	CASTING WEIGHT (G)	SECTIONS	TRANSP. LENGTH (CM)
LJASN-992MF	9,9/2,97	192	M	F	10-35	2	153



## SPINNING ROD ANIRA MICROJIG 5

### BLANK:

- Material – carbon fiber (40T)
- Action – **fast F**
- Class – **ultra light UL**
- Joint type – **OVER STEEK**

### HANDLE:

- Material – hard **EVA**
- Screw type reel seat

### GUIDES:

- Anti-tangle
- **SIC** inserts

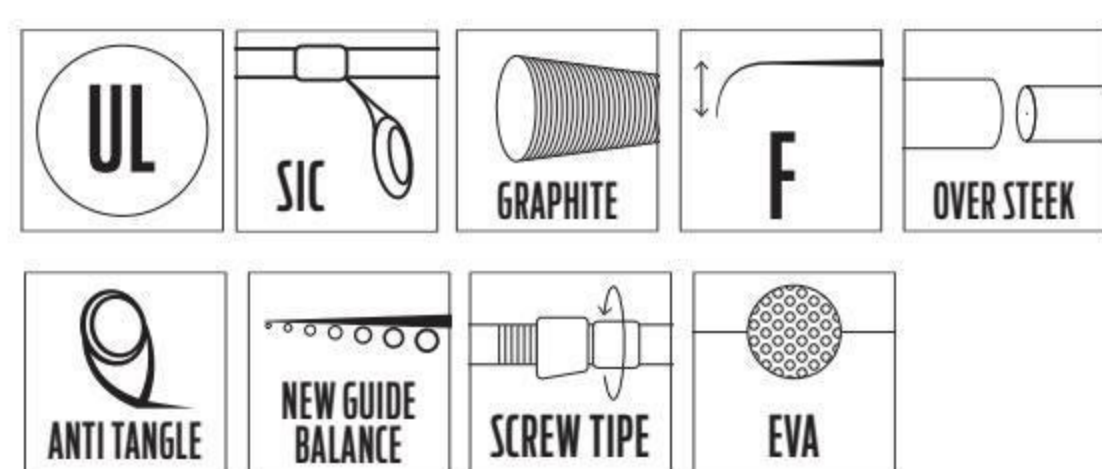

ITEM NO.	LENGTH (FT/M)	WEIGHT (G)	CLASS	ACTION	CASTING WEIGHT (G)	SECTIONS	TRANSP. LENGTH (CM)
LJA-662ULF	6,6/1,98	87	U-Light	Fast	0,7-5	2	104
LJA-712ULF	7,1/2,16	92	U-Light	Fast	0,7-5	2	111
LJA-752ULF	7,5/2,26	96	U-Light	Fast	0,7-5	2	118

## SPINNING ROD ANIRA 14

### BLANK:

- Material – carbon fiber (40T)
- Action – **fast F**
- Class – **light L**
- Joint type – **OVER STEEK**

### HANDLE:

- Material – hard **EVA**
- Screw type **FUJI** reel seat

### GUIDES:

- Anti-tangle **FUJI**
- **SIC** inserts

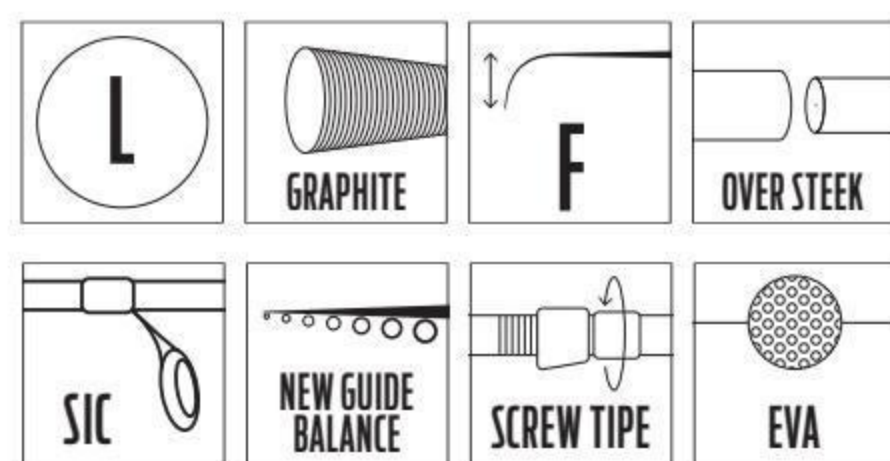

ITEM NO.	LENGTH (FT/M)	WEIGHT (G)	CLASS	ACTION	CASTING WEIGHT (G)	SECTIONS	TRANSP. LENGTH (CM)
LJA-712LF	7,1/2,16	92	L	F	4-14	2	112
LJA-762LMF	7,6/2,29	98	L	MF	4-14	2	119

## SPINNING ROD ANIRA 24

### BLANK:

- Material - carbon fiber (40T)
- Action - **fast F**
- Class - **medium light ML**
- Joint type - **OVER STEEK**

### HANDLE:

- Material - hard **EVA**
- Screw type **FUJI** reel seat

### GUIDES

- Anti-tangle **FUJI**
- **SIC** inserts

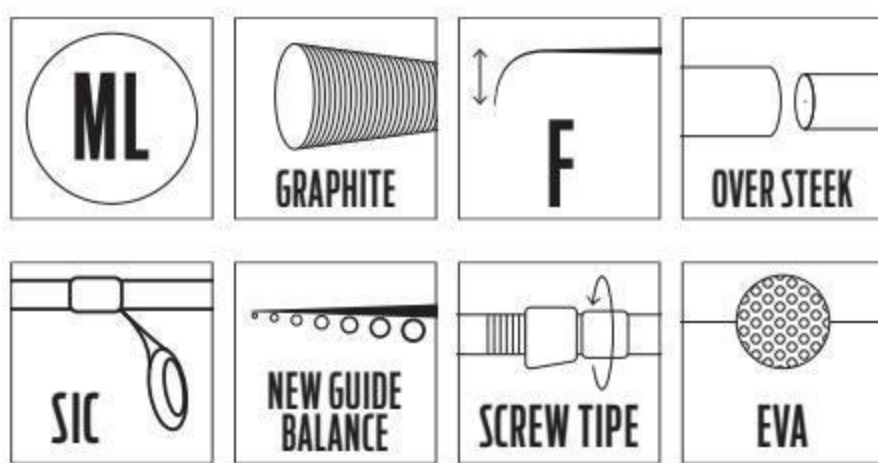

ITEM NO.	LENGTH (FT/M)	WEIGHT (G)	CLASS	ACTION	CASTING WEIGHT (G)	SECTIONS	TRANSP. LENGTH (CM)
LJA-712MLF	7,1/2,16	93	ML	F	5-24	2	112
LJA-762MLF	7,6/2,29	104	ML	F	5-24	2	119
LJA-802MLF	8,0/2,44	110	ML	F	5-24	2	126

## SPINNING ROD ANIRA 34

### BLANK:

- Material - carbon fibre (40T)
- Action - **fast F**
- Class - **medium M**
- Joint type - **OVER STEEK**

### HANDLE:

- Material - hard **EVA**
- Screw type **FUJI** reel seat

### GUIDES:

- Anti-tangle **FUJI**
- **SIC** inserts

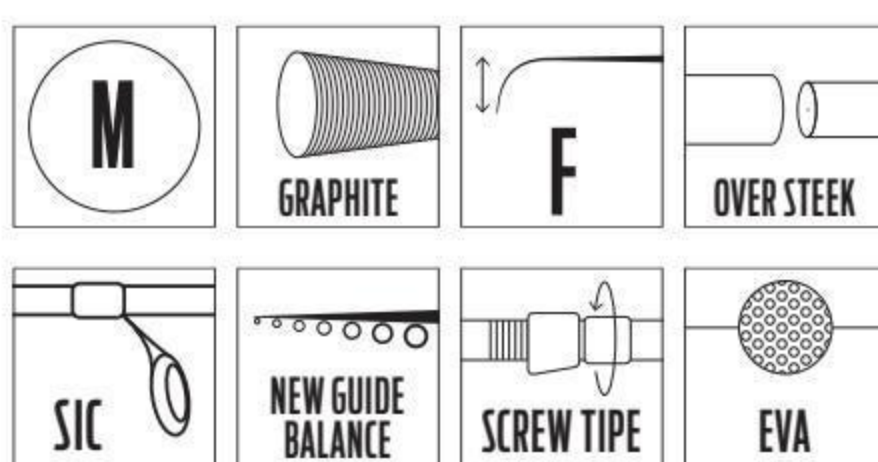

ITEM NO.	LENGTH (FT/M)	WEIGHT (G)	CLASS	ACTION	CASTING WEIGHT (G)	SECTIONS	TRANSP. LENGTH (CM)
LJA-712MF	7,1/2,16	100	M	F	8-34	2	112
LJA-762MF	7,6/2,29	106	M	F	8-34	2	119
LJA-822MF	8,2/2,49	124	M	F	8-34	2	129

## SPINNING ROD ANIRA 45

### BLANK:

- Material – carbon fiber (40T)
- Action – **extra fast EF**
- Class – **medium heavy MH**
- Joint type – **OVER STEEK**

### HANDLE:

- Material – hard **EVA**
- Screw type **FUJI** reel seat

### GUIDES:

- Anti-tangle **FUJI**
- **SIC** inserts

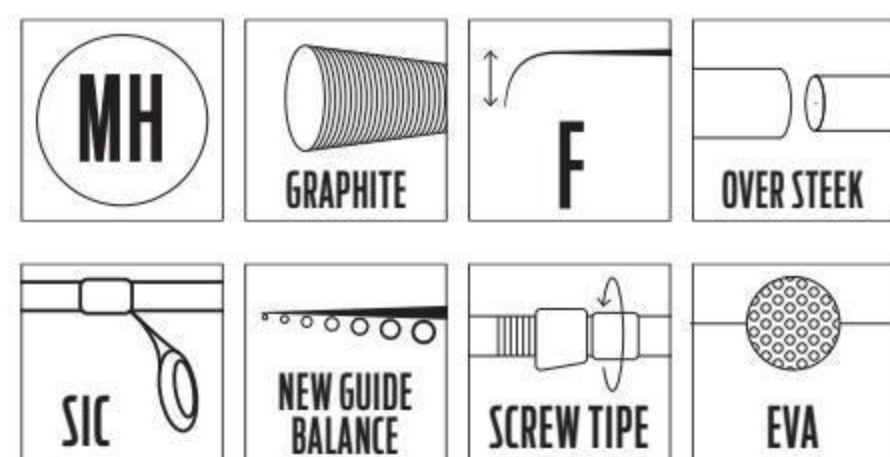

ITEM NO.	LENGTH (FT/M)	WEIGHT (G)	CLASS	ACTION	CASTING WEIGHT (G)	SECTIONS	TRANSP. LENGTH (CM)
LJA-782MHEF	7,8/2,34	123	MH	EF	12-45	2	121
LJA-822MHEF	8,2/2,49	131	MH	EF	12-45	2	129
LJA-902MHEF	9,0/2,74	161	MH	EF	12-45	2	142

## SPINNING ROD ANIRA 60

### BLANK:

- Material – carbon fibre (40T)
- Action – **extra fast EF**
- Class – **heavy H**
- Joint type – **OVER STEEK**

### HANDLE:

- Material – hard **EVA**
- Screw type **FUJI** reel seat

### GUIDES:

- Anti-tangle **FUJI**
- **SIC** inserts

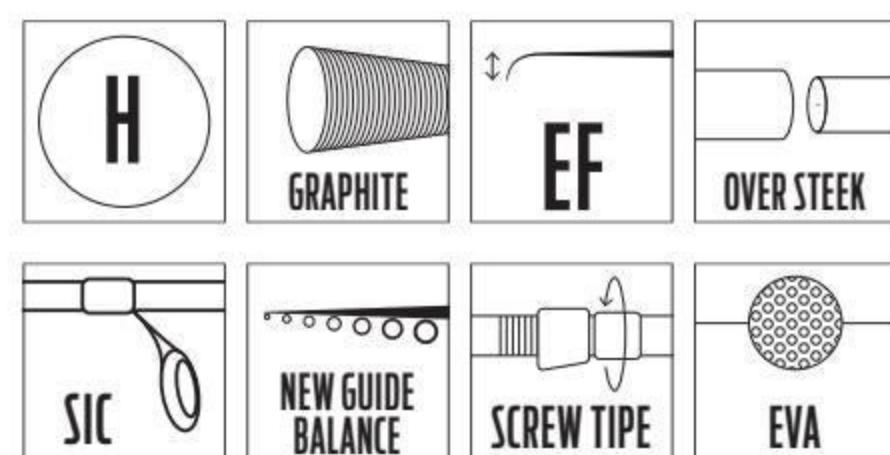

ITEM NO.	LENGTH (FT/M)	WEIGHT (G)	CLASS	ACTION	CASTING WEIGHT (G)	SECTIONS	TRANSP. LENGTH (CM)
LJA-822HEF	8,2/2,49	145	H	EF	15-60	2	129
LJA-902HEF	9,0/2,74	176	H	EF	15-60	2	142

## SPINNING ROD ANIRA STREAM 10

### BLANK:

- Material – carbon fiber (40T)
- Action – **medium M**
- Class – **light L**
- Joint type – **OVER STEEK**

### HANDLE:

- Material – hard **EVA**
- Screw type **FUJI** reel seat

### GUIDES:

- Anti-tangle **FUJI**
- **SIC** inserts

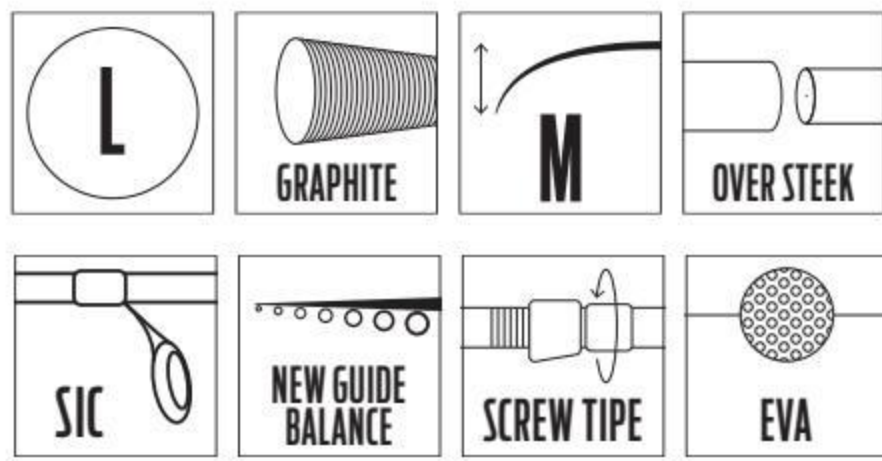
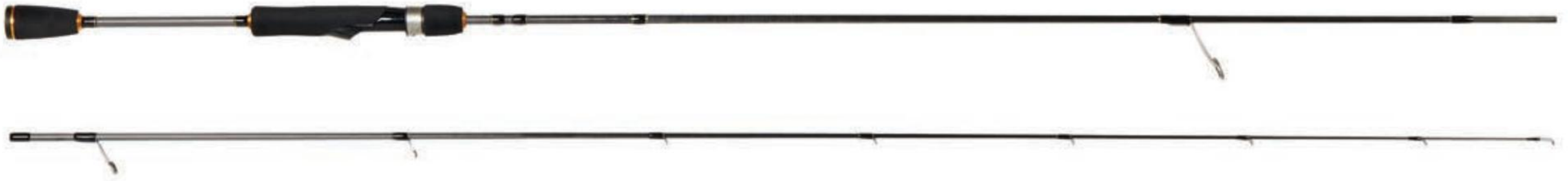

ITEM NO.	LENGTH (FT/M)	WEIGHT (G)	CLASS	ACTION	CASTING WEIGHT (G)	SECTIONS	TRANSP. LENGTH (CM)
LJASM-7112LM	7,11/2,16	102	L	M	3-10	2	126
LJASM-8102LM	8,1/2,46	117	L	M	3-10	2	140



## LUCKY JOHN SPINNING RODS BLACK SENSE

ITEM NO.	SERIES	MODEL	BLANK MATERIAL	ACTION	LENGTH (FT/M)	WEIGHT (G)	CASTING WEIGHT (G)	SECTIONS	TRANSP. LENGTH (CM)
LJBSBBS-732XHEFC	Black Sense	JERK&TWITCH 110	Toray carbon fiber	extra fast	7,3/2,21	192	40-110	2	114
LJBSBBS-752XHEFC	Black Sense	JERK&TWITCH 150	Toray carbon fiber	extra fast	7,5/2,26	207	50-150	2	116,5
LJBSBBS-802HEFC	Black Sense	BBS CAST 70	Toray carbon fiber	extra fast	8,0"/2,44	228	25-70	2	126
LJBSBBS-802XHEFC	Black Sense	BBS CAST 110	Toray carbon fiber	extra fast	8,0"/2,44	235	25-110	2	126
LJBSBBS-802XHEFS	Black Sense	BBS SPIN 110	Toray carbon fiber	extra fast	8,0"/2,44	240	25-110	2	126
LJBSBBS-842XHEFC	Black Sense	BBS CAST 150	Toray carbon fiber	extra fast	8,4"/2,54	275	35-150	2	132
LJBSBBS-862XHEFC	Black Sense	BBS CAST 220	Toray carbon fiber	extra fast	8,6"/2,59	310	45-220	2	134
LJBSBBS-882XHEFC	Black Sense	BBS CAST 280	Toray carbon fiber	extra fast	8'8"/2,64	337	70-280	2	136,5
LJBSF-662LFC	Black Sense	FARAON CAST 14	Toray carbon fiber	fast	6,6"/1,98	120	4-14	2	102
LJBSF-732LFC	Black Sense	FARAON CAST 14	Toray carbon fiber	fast	7,3"/2,21	130	4-14	2	114
LJBSF-662MLFC	Black Sense	FARAON CAST 21	Toray carbon fiber	fast	6,6"/1,98	125	6-21	2	102
LJBSF-732MLFC	Black Sense	FARAON CAST 21	Toray carbon fiber	fast	7,3"/2,21	135	6-21	2	114
LJBSF-662MFC	Black Sense	FARAON CAST 28	Toray carbon fiber	fast	6,6"/1,98	130	8-28	2	102
LJBSF-732MFC	Black Sense	FARAON CAST 28	Toray carbon fiber	fast	7,3"/2,21	140	8-28	2	114
LJBSF-662MHFC	Black Sense	FARAON CAST 42	Toray carbon fiber	fast	6,6"/1,98	135	15-42	2	102
LJBSF-732MHFC	Black Sense	FARAON CAST 42	Toray carbon fiber	fast	7,3"/2,21	145	15-42	2	114

### LUCKY JOHN ROD **BLACK SENSE JERK&TWITCH 110/150**

**NEW**

**BLANK:**

- Material - Toray carbon fiber (40T)
- Action - **extra fast EF**
- Class - **extra heavy XH**
- Joint type - **OVER STEEK**

**HANDLE:**

- Material - hard **EVA**
- Screw in type reel seat

**GUIDES:**

- Reinforced
- Low profile
- **SIC** inserts
- Anti-tagle



**BBS**  
BIG BAIT SERIES

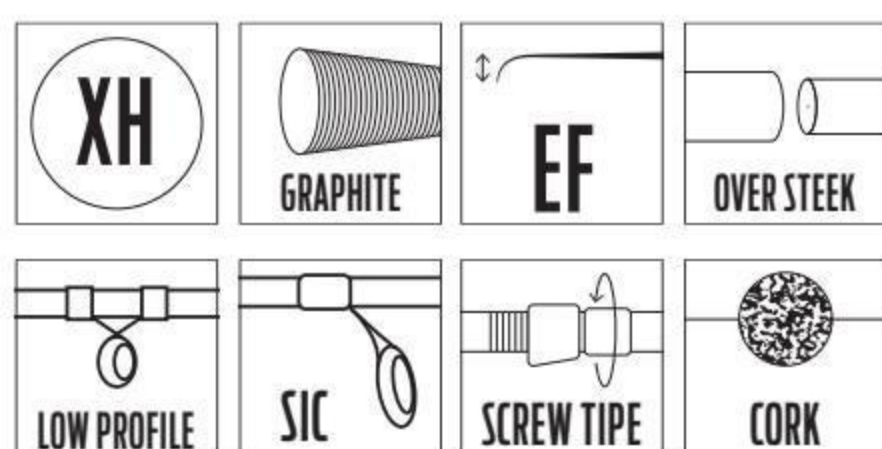

ITEM NO.	LENGTH (F/M)	WIGHT (G)	CLASS	ACTION	CASTING WIGHT (G)	SECTIONS	TRANSP.LENGTH (CM)
LJBSBBS-732XHEFC	7,3/2,21	192	XH	extra fast	40-110	2	114
LJBSBBS-752XHEFC	7,5/2,26	207	XH	extra fast	50-150	2	116,5

### LUCKY JOHN ROD **BLACK SENSE BBS CAST 070**

**NEW**

**BLANK:**

- Material - Toray carbon fiber (30T)
- Action - **extra fast EF**
- Class - **heavy H**
- Joint type - **OVER STEEK**

**HANDLE:**

- Material - hard **EVA**
- Screw in type reel seat

**GUIDES:**

- Reinforced
- Low profile
- **SIC** inserts
- Anti-tagle

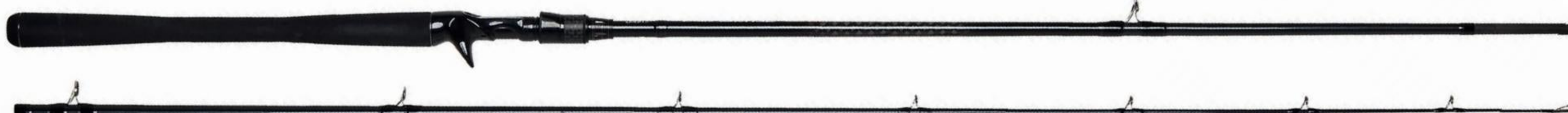

**BBS**  
BIG BAIT SERIES

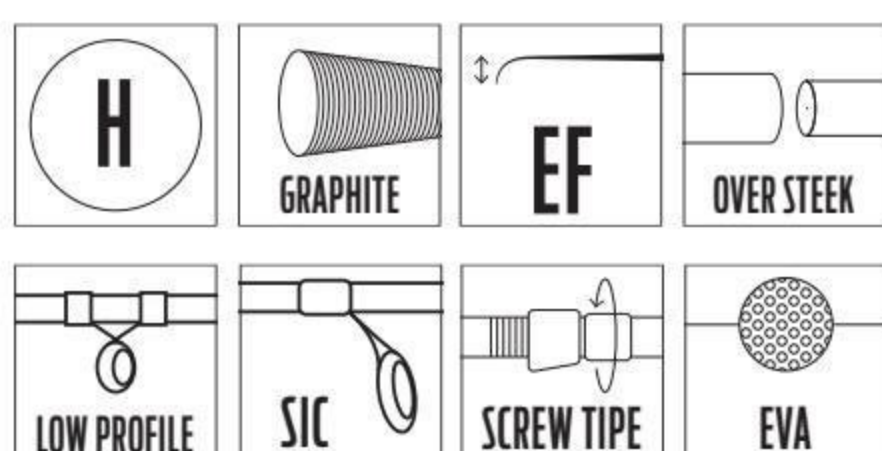

ITEM NO.	LENGTH (F/M)	WEIGHT (G)	CLASS	ACTION	CASTING WEIGHT (G)	SECTIONS	TRANSP. LENGTH (CM)
LJBSBBS-802HEFC	8,0"/2,44	228	H	extra fast	25-70	2	126

## LUCKY JOHN ROD **BLACK SENSE BBS CAST 110**

### BLANK:

- Material – Toray carbon fiber (**30T**)
- Action – **extra fast EF**
- Class – **extra heavy XH**
- Joint type – **OVER STEEK**

### HANDLE:

- Material – hard **EVA**
- Screw type reel seat

### GUIDES:

- **SIC** inserts
- Anti tangle

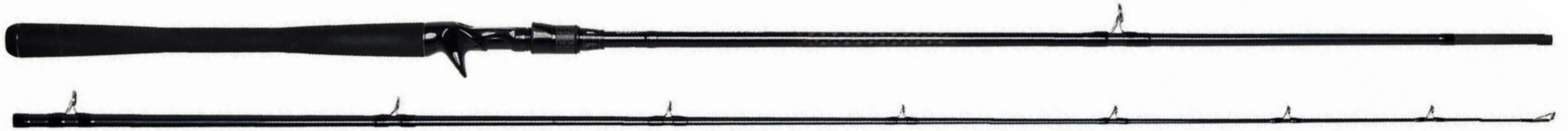

## **BBS** BIG BAIT SERIES

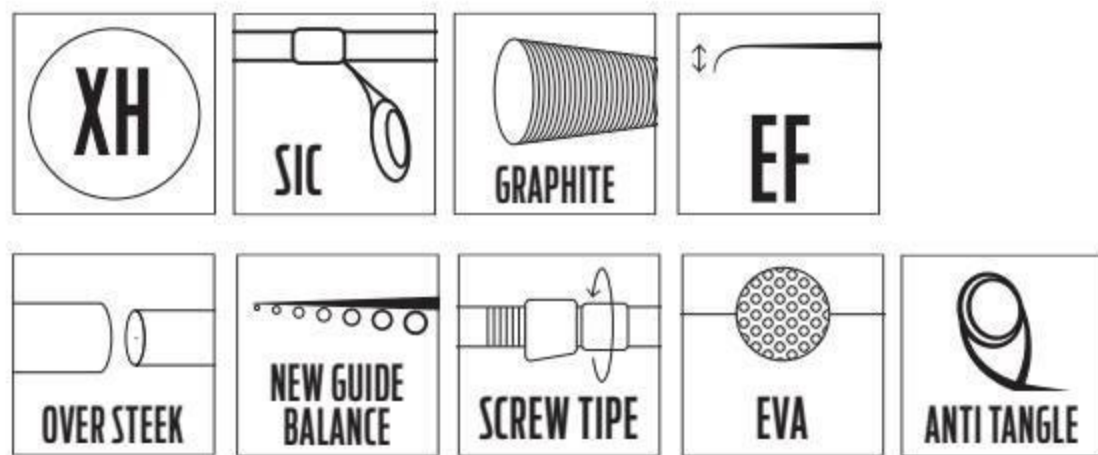

ITEM NO.	LENGTH (FT/M)	WEIGHT (G)	CLASS	ACTION	CASTING WEIGHT (G)	SECTIONS	TRANSP. LENGTH (CM)
LJBSBBS-802XHEFC	8,0"/2,44	235	XH	EF	25-110	2	126

## LUCKY JOHN ROD **BLACK SENSE BBS SPIN 110**

### BLANK:

- Material – Toray carbon fiber (**30T**)
- Action – **extra fast EF**
- Class – **extra heavy XH**
- Joint type – **OVER STEEK**

### HANDLE:

- Material – hard **EVA**
- Screw type reel seat

### GUIDES:

- Anti-tangle
- **SIC** inserts

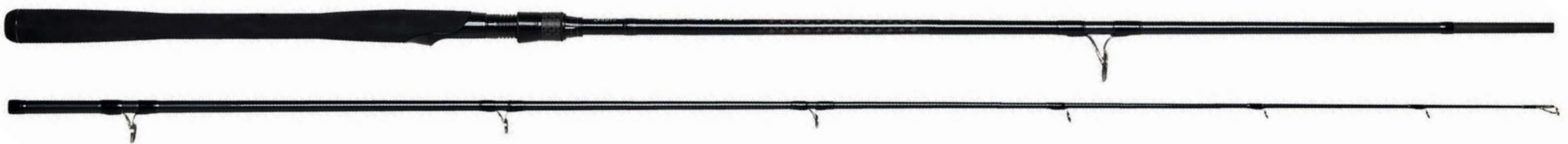

## **BBS** BIG BAIT SERIES

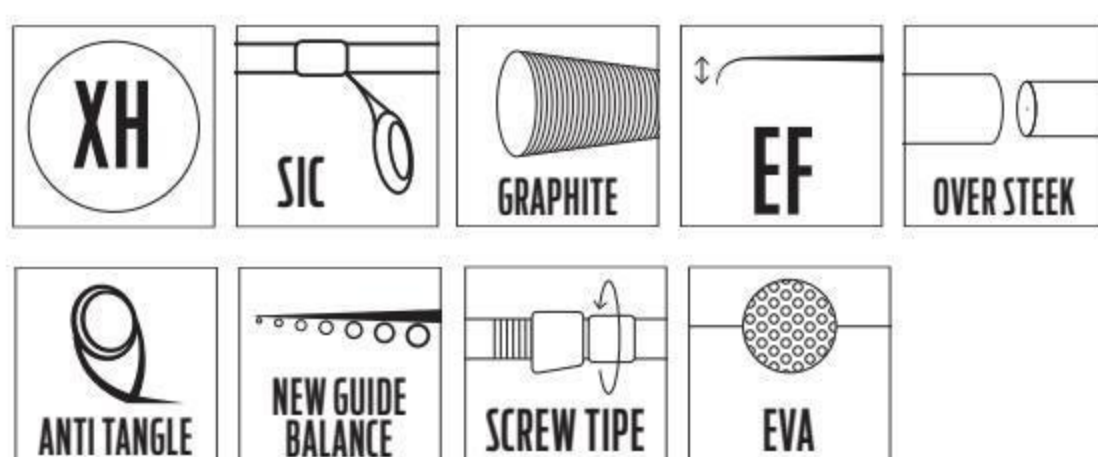

ITEM NO.	LENGTH (FT/M)	WEIGHT (G)	CLASS	ACTION	CASTING WEIGHT (G)	SECTIONS	TRANSP. LENGTH (CM)
LJBSBBS-802XHEFS	8,0"/2,44	240	XH	EF	25-110	2	126

## LUCKY JOHN ROD **BLACK SENSE BBS CAST 150**

### BLANK:

- Material – Toray carbon fiber (**30T**)
- Action – **extra fast EF**
- Class – **extra heavy XH**
- Joint type – **OVER STEEK**

### HANDLE:

- Material – hard **EVA**
- Screw type reel seat

### GUIDES:

- **SIC** inserts
- Anti tangle

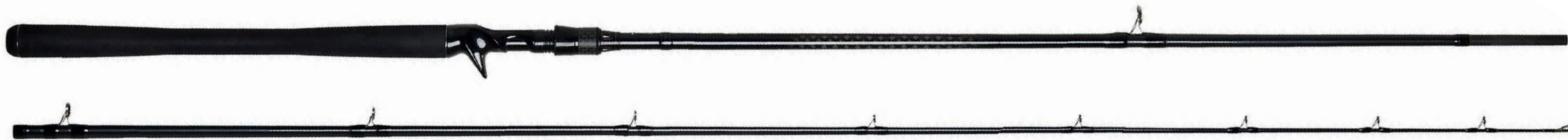

**BBS**  
BIG BAIT SERIES

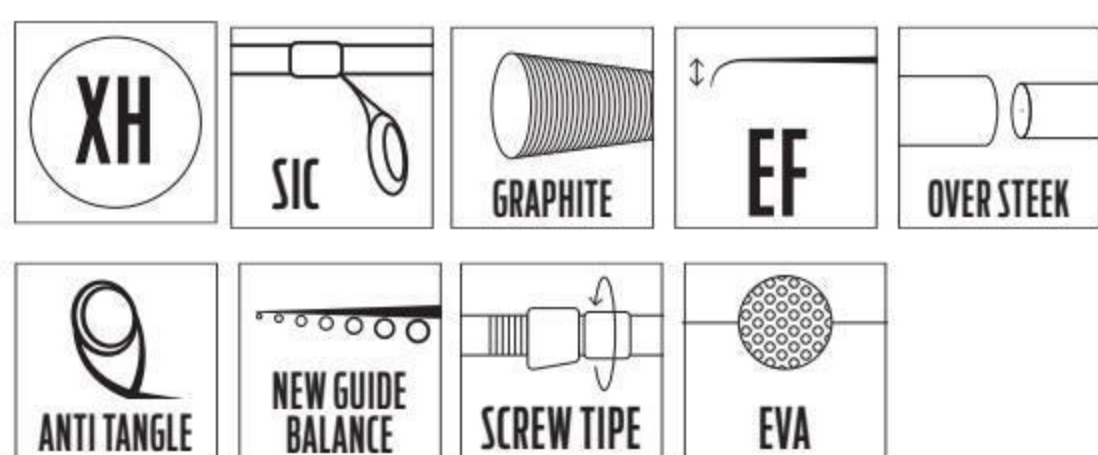

ITEM NO.	LENGTH (FT/M)	WEIGHT (G)	CLASS	ACTION	CASTING WEIGHT (G)	SECTIONS	TRANSP. LENGTH (CM)
LJBSBBS-842XHEFC	8,4"/2,54	275	XH	EF	35-150	2	132

## LUCKY JOHN ROD **BLACK SENSE BBS CAST 220**

### BLANK:

- Material – Toray carbon fiber (**30T**)
- Action – **extra fast EF**
- Class – **extra heavy XH**
- Joint type – **OVER STEEK**

### HANDLE:

- Material – hard **EVA**
- Screw type reel seat

### GUIDES:

- **SIC** inserts
- Anti tangle

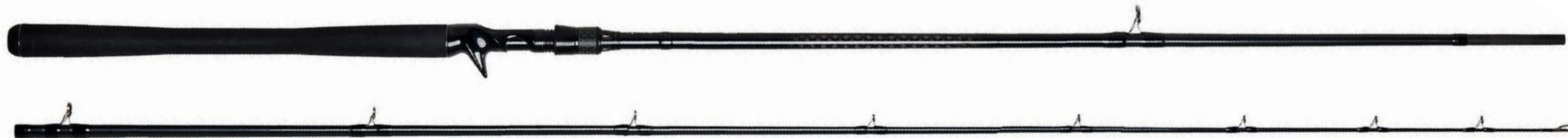

**BBS**  
BIG BAIT SERIES

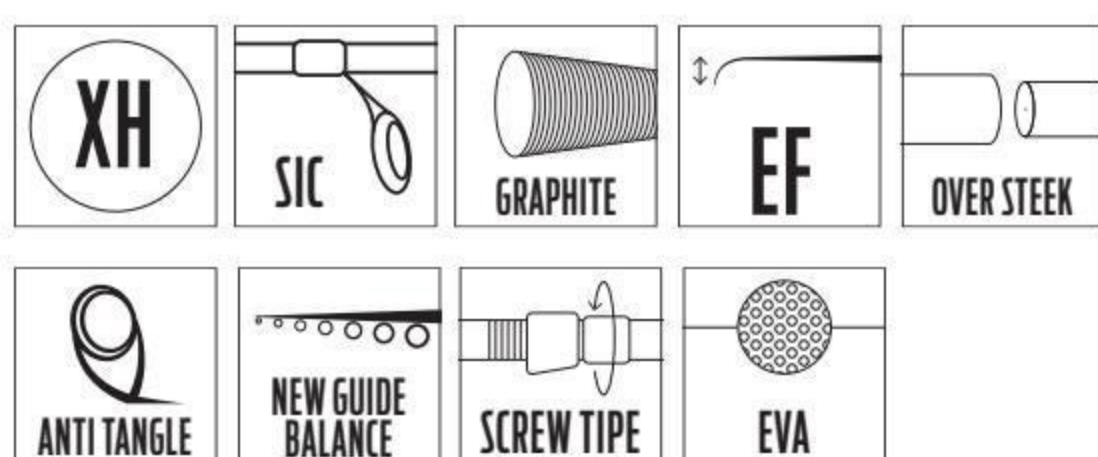

ITEM NO.	LENGTH (FT/M)	WEIGHT (G)	CLASS	ACTION	CASTING WEIGHT (G)	SECTIONS	TRANSP. LENGTH (CM)
LJBSBBS-862XHEFC	8,6"/2,59	310	XH	EF	45-220	2	134

**NEW**

## LUCKY JOHN ROD **BLACK SENSE BBS CAST 280**

**BLANK:**

- Material – Toray carbon fiber (**30T**)
- Action – **extra fast EF**
- Class – **extra heavy XH**
- Joint type – **OVER STEEK**

**HANDLE:**

- Material – hard **EVA**
- Screw type reel seat

**GUIDES:**

- Reinforced
- Low profile
- **SIC** inserts
- Anti-tagle



**BBS**  
BIG BAIT SERIES

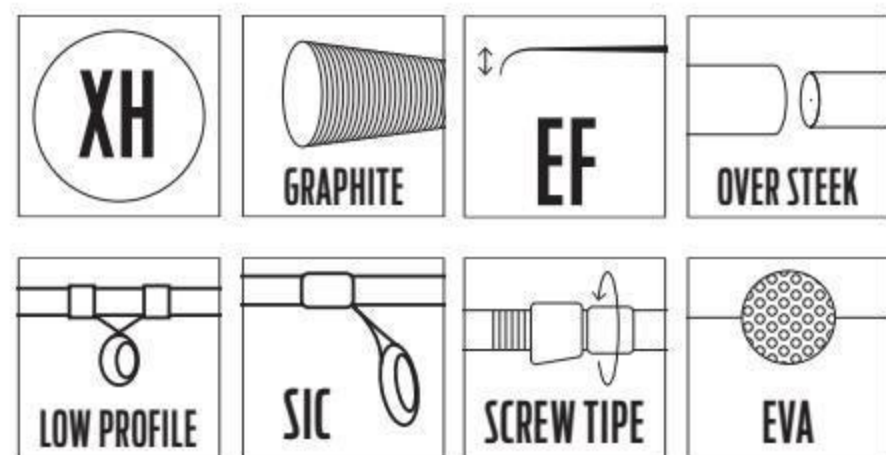

ITEM NO.	LENGTH (FT/M)	WEIGHT (G)	CLASS	ACTION	CASTING WEIGHT (G)	SECTIONS	TRANSP. LENGTH (CM)
LJBSBBS-882XHEFC	8,8"/2,64	337	XH	EF	70-280	2	136,5

## LUCKY JOHN ROD **BLACK SENSE FARAON CAST 14**

**BLANK:**

- Material – Toray carbon fiber (**30T**)
- Action – **fast F**
- Class – **light L**
- Joint type – **OVER STEEK**

**HANDLE:**

- Material – hard **EVA**
- Screw type reel seat

**GUIDES:**

- **SIC** inserts
- Anti tangle



**BBS**  
BIG BAIT SERIES

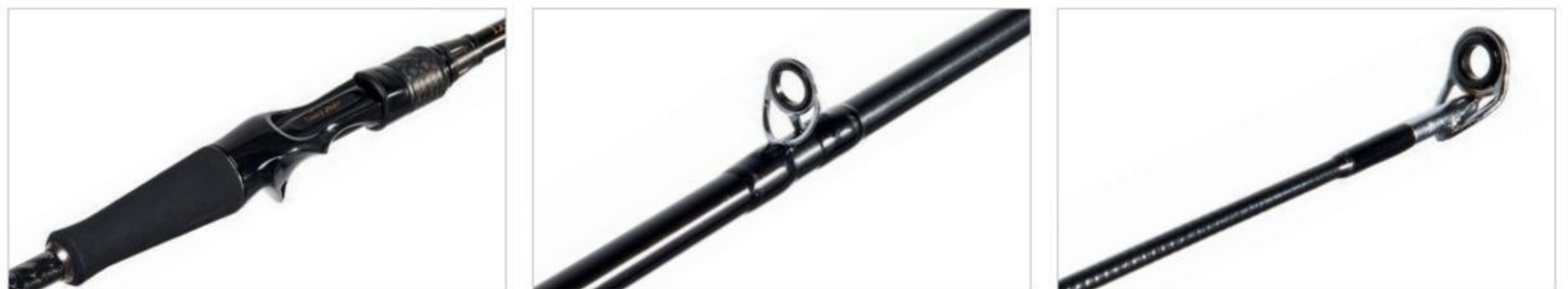
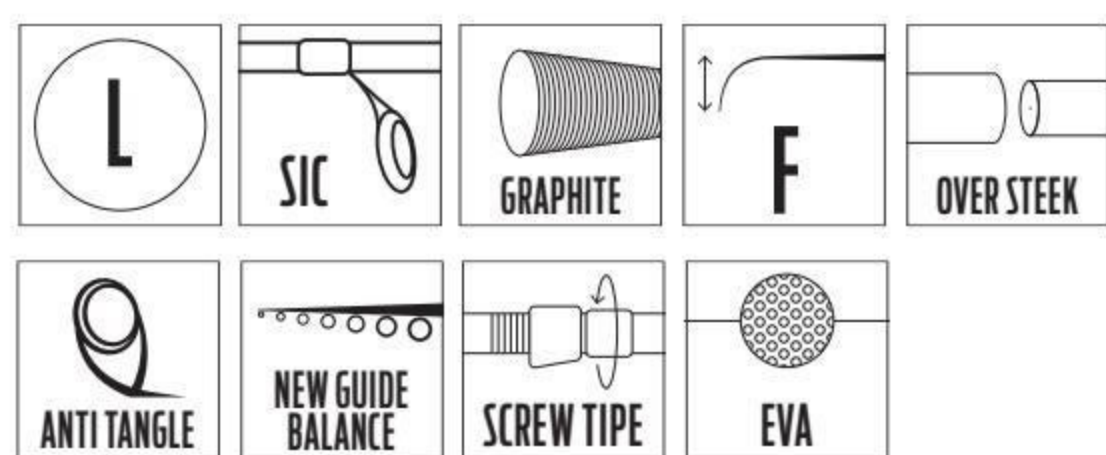

ITEM NO.	LENGTH (FT/M)	WEIGHT (G)	CLASS	ACTION	CASTING WEIGHT (G)	SECTIONS	TRANSP. LENGTH (CM)
LJBSF-662LFC	6,6"/1,98	120	L	F	4-14	2	102
LJBSF-732LFC	7,3"/2,21	130	L	F	4-14	2	114



## LUCKY JOHN ROD **BLACK SENSE FARAON CAST 21**

### BLANK:

- Material – Toray carbon fiber **(30T)**
- Action – **fast F**
- Class – **medium light ML**
- Joint type – **OVER STEEK**

### HANDLE:

- Material – hard **EVA**
- Screw type reel seat

### GUIDES:

- **SIC** inserts
- Anti tangle



**BBS**  
BIG BAIT SERIES

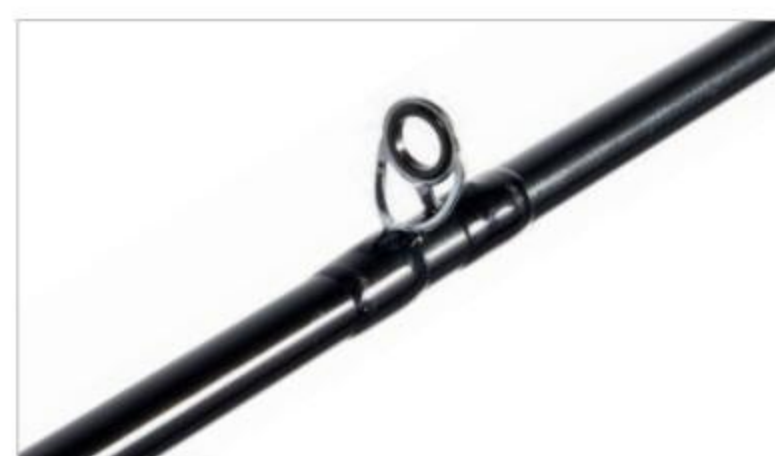
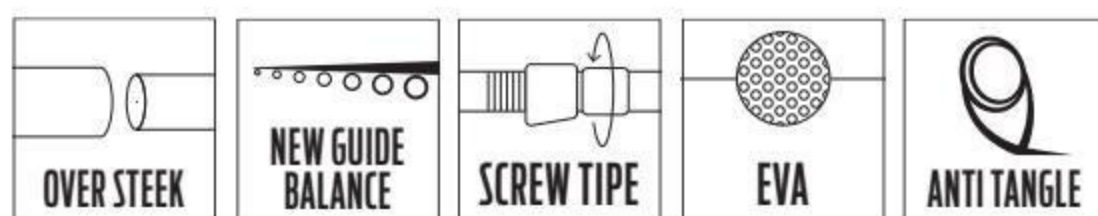
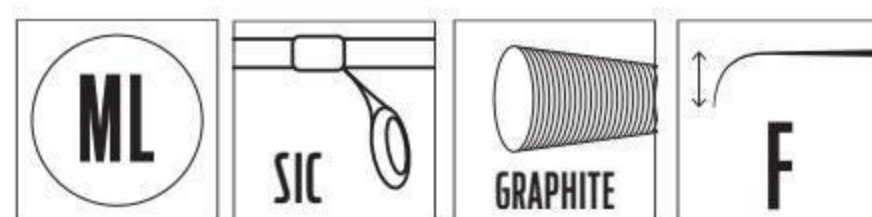

ITEM NO.	LENGTH (FT/M)	WEIGHT (G)	CLASS	ACTION	CASTING WEIGHT (G)	SECTIONS	TRANSP. LENGTH (CM)
LJBSF-662MLFC	6,6"/1,98	125	ML	F	6-21	2	102
LJBSF-732MLFC	7,3"/2,21	135	ML	F	6-21	2	114

## LUCKY JOHN ROD **BLACK SENSE FARAON CAST 28**

### BLANK:

- Material – Toray carbon fiber **(30T)**
- Action – **fast F**
- Class – **medium M**
- Joint type – **OVER STEEK**

### HANDLE:

- Material – hard **EVA**
- Screw type reel seat

### GUIDES:

- **SIC** inserts
- Anti tangle



**BBS**  
BIG BAIT SERIES

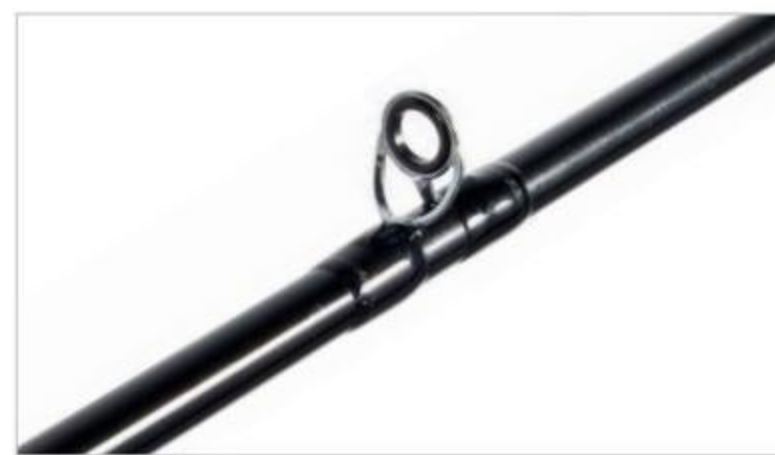
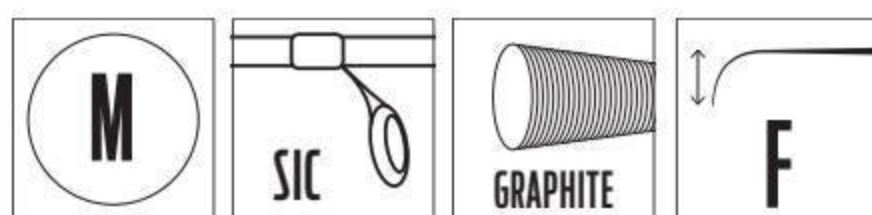

ITEM NO.	LENGTH (FT/M)	WEIGHT (G)	CLASS	ACTION	CASTING WEIGHT (G)	SECTIONS	TRANSP. LENGTH (CM)
LJBSF-662MFC	6,6"/1,98	130	M	F	8-28	2	102
LJBSF-732MFC	7,3"/2,21	140	M	F	8-28	2	114

## LUCKY JOHN ROD **BLACK SENSE FARAON CAST 42**

### BLANK:

- Material – Toray carbon fiber (30T)
- Action – **fast F**
- Class – **medium heavy MH**
- Joint type – **OVER STEEK**

### HANDLE:

- Material – hard **EVA**
- Screw type reel seat

### GUIDES:

- **SIC** inserts
- Anti tangle



## **BBS** BIG BAIT SERIES

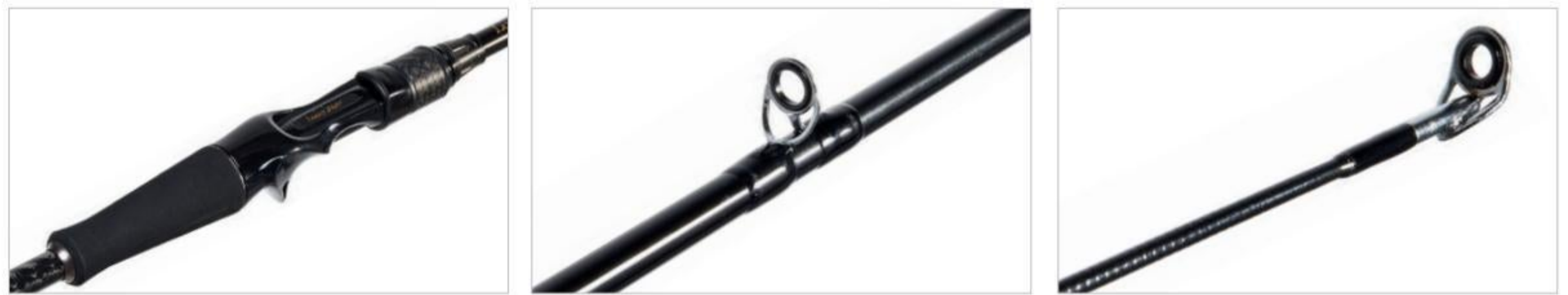
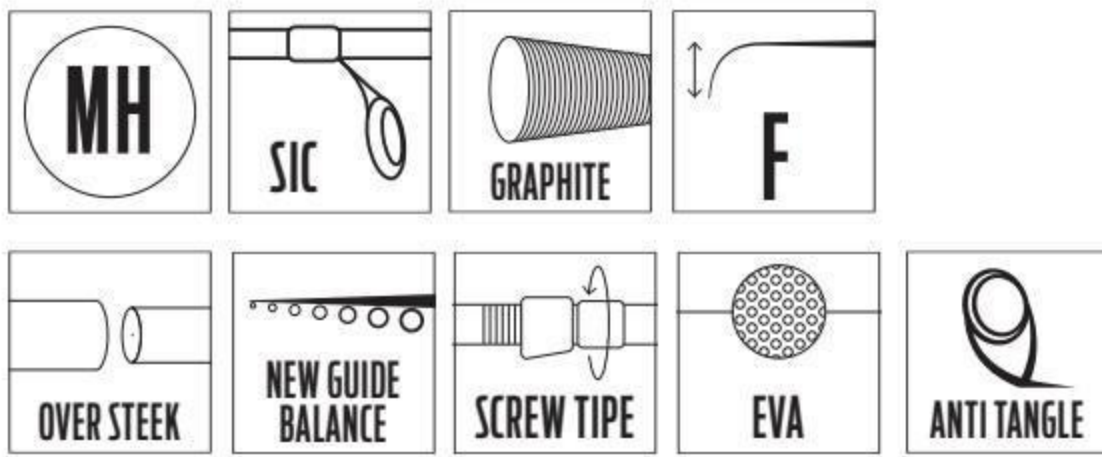

ITEM NO.	LENGTH (FT/M)	WEIGHT (G)	CLASS	ACTION	CASTING WEIGHT (G)	SECTIONS	TRANSP. LENGTH (CM)
LJBSF-662MHFC	6,6"/1,98	135	MH	F	15-42	2	102
LJBSF-732MHFC	7,3"/2,21	145	MH	F	15-42	2	114



## LUCKY JOHN SPINNING RODS PROGRESS SERIES

ITEM NO.	SERIES	MODEL	BLANK MATERIAL	ACTION	LENGTH (FT/M)	WEIGHT (G)	CASTING WEIGHT (G)	SECTIONS	TRANSP. LENGTH (CM)
LJPC-902LS	Progress	CHUB 10	Carbon fiber	medium	9,0"/2,74	121	3-10	2	143
LJPC-802LS	Progress	CHUB 10	Carbon fiber	medium	8,0"/2,44	106	3-10	2	125
LJPMX-602ULMF	Progress	MORMIX 03	Carbon fiber	medium fast	6,0"/1,83	74	0,5-3	2	95
LJPMX-662ULMF	Progress	MORMIX 03	Carbon fiber	medium fast	6,6"/1,98	80	0,5-3	2	102
LJPSW-762HF	Progress	SWIMBAIT	Carbon fiber	fast	7,6"/2,29	155	15-56	2	118
LJPSW-762MHF	Progress	SWIMBAIT	Carbon fiber	fast	7,6"/2,29	147	10-42	2	118
LJPSW-822HF	Progress	SWIMBAIT	Carbon fiber	fast	8,2"/2,49	172	15-56	2	129
LJPSW-822MHF	Progress	SWIMBAIT	Carbon fiber	fast	8,2"/2,49	164	10-42	2	129
LJPP-782MHF	Progress	POWERJIG 40	Carbon fiber	fast	7,8"/2,34	125	12-40	2	121
LJPP-822MHF	Progress	POWERJIG 40	Carbon fiber	fast	8,2"/2,48	135	12-40	2	129
LJPP-902MHF	Progress	POWERJIG 40	Carbon fiber	fast	9,0"/2,74	154	12-40	2	142
LJPP-822HF	Progress	POWERJIG 56	Carbon fiber	fast	8,2"/2,48	140	15-56	2	129
LJPP-902HF	Progress	POWERJIG 56	Carbon fiber	fast	9,0"/2,74	173	15-56	2	142
LJPP-852HEF	Progress	POWERJIG 80	Carbon fiber	fast	8,5"/2,57	122	30-80	2	134
LJPP-902HEF	Progress	POWERJIG 80	Carbon fiber	fast	9,0"/2,74	187	30-80	2	142

### SPINNING ROD PROGRESS CHUB 10

Delicate light class spinning rod.

**BLANK:**

- Material - carbon fiber (30T)
- Action - **medium M**
- Class - **light L**
- Joint type - **OVER STEEK**
- Loop shape hook keeper

**HANDLE:**

- Material - hard **EVA**
- Screw type reel seat

**GUIDES:**

- Anti-tangle
- **SIC** inserts

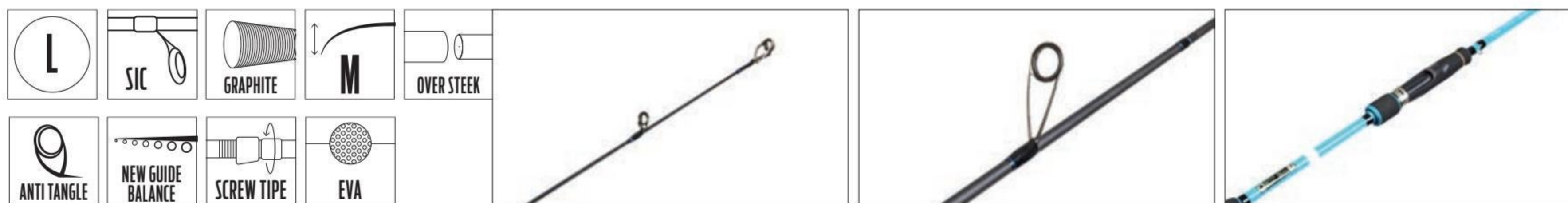

ITEM NO.	LENGTH (FT/M)	WEIGHT (G)	ACTION	CASTING WEIGHT (G)	SECTIONS	TRANSP. LENGTH (CM)
LJPC-902LS	9,0/2,74	121	M	3-10	2	143
LJPC-802LS	8,0/2,44	106	M	3-10	2	125

### SPINNING ROD PROGRESS MORMIX 03

Super sensitive spinning rod for catching predatory fish with very light and small jig heads. The sensitive rod tip will show the slightest movement of any lure.

**BLANK:**

- Material - carbon fiber (30T)
- Action - **medium fast MF**
- Class - **ultra light UL**
- Joint type - **OVER STEEK**

**HANDLE:**

- Material - hard **EVA**
- Screw type reel seat

**GUIDES:**

- Lightweight
- Anti-tangle
- **SIC** inserts

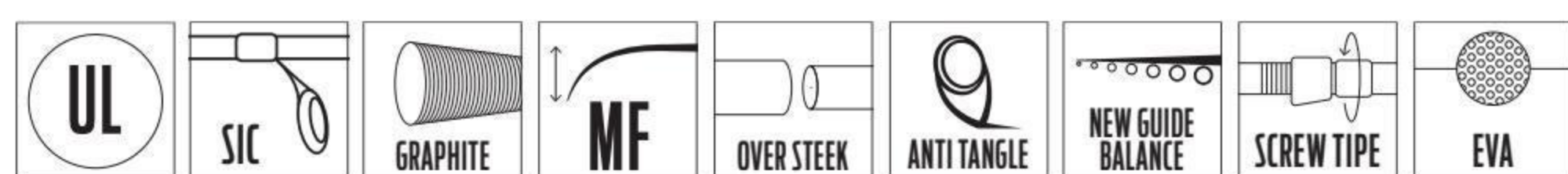

ITEM NO.	LENGTH (FT/M)	WEIGHT (G)	CLASS	ACTION	CASTING WEIGHT (G)	SECTIONS	TRANSP. LENGTH (CM)
LJPMX-602ULMF	6,0/1,83	74	UL	MF	0,5-3	2	95
LJPMX-662ULMF	6,6/1,98	80	UL	MF	0,5-3	2	102

## SPINNING ROD **PROGRESS SWIMBAIT**

Powerful, fast action spinning rod for fishing with heavy lures and jig heads, suitable for use with a multiplier reel.

**BLANK:**

- Material – carbon fiber **(30T)**
- Action – **fast F**
- Class – **heavy H**
- Joint type – **OVER STEEK**

**HANDLE:**

- Material – hard **EVA**
- Screw type reel seat

**GUIDES:**

- **SIC** inserts



ITEM NO.	LENGTH (FT/M)	WEIGHT (G)	CLASS	ACTION	CASTING WEIGHT (G)	SECTIONS	TRANSP. LENGTH (CM)
LJPSW-762HF	7,6/2,29	155	H	F	15-56	2	118
LJPSW-762MHF	7,6/2,29	147	MH	F	10-42	2	118
LJPSW-822HF	8,2/2,49	172	H	F	15-56	2	129
LJPSW-822MHF	8,2/2,49	164	MH	F	10-42	2	129

## SPINNING ROD **PROGRESS POWERJIG 40**

Powerful spinning rod for fishing with heavy jigs. Durability and sensitivity are the main features of this rod.

**BLANK:**

- Material – carbon fiber **(30T)**
- Action – **fast F**
- Class – **medium heavy MH**
- Joint type – **OVER STEEK**
- Loop shape hook keeper

**HANDLE:**

- Material – hard **EVA**
- Screw type reel seat

**GUIDES:**

- Anti-tangle
- **SIC** inserts

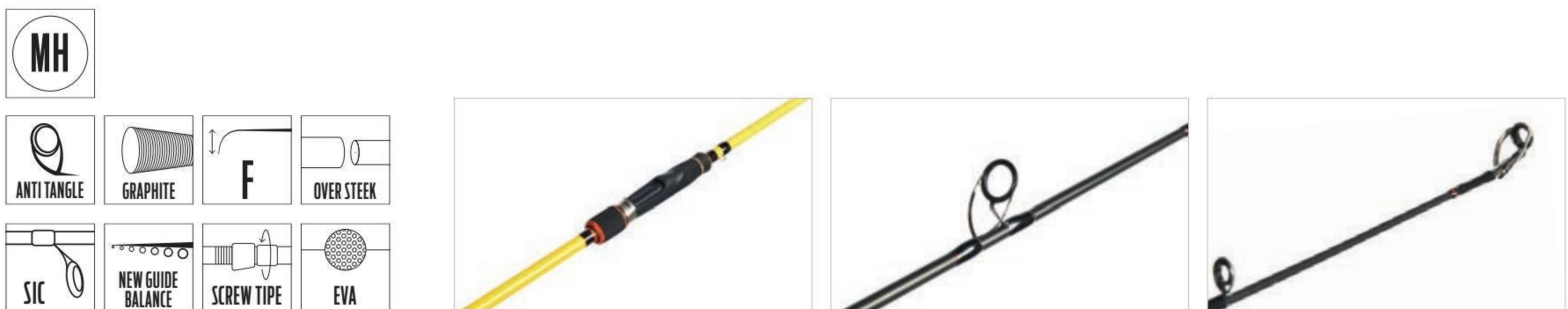

ITEM NO.	LENGTH (FT/M)	WEIGHT (G)	CLASS	ACTION	CASTING WEIGHT (G)	SECTIONS	TRANSP. LENGTH (CM)
LJPP-782MHF	7,8/2,34	125	M-Heavy	Fast	12-40	2	121
LJPP-822MHF	8,2/2,48	135	M-Heavy	Fast	12-40	2	129
LJPP-902MHF	9,0/2,74	154	M-Heavy	Fast	12-40	2	142

## SPINNING ROD **PROGRESS POWERJIG 56**

Powerful spinning rod for fishing with heavy jigs. Durability and sensitivity are the main features of this rod.

### BLANK:

- Material – carbon fiber **(30T)**
- Action – **fast F**
- Class – **heavy H**
- Joint type – **OVER STEEK**
- Loop shape hook keeper

### HANDLE:

- Material – hard **EVA**
- Screw type reel seat

### GUIDES:

- Anti-tangle
- **SIC** inserts

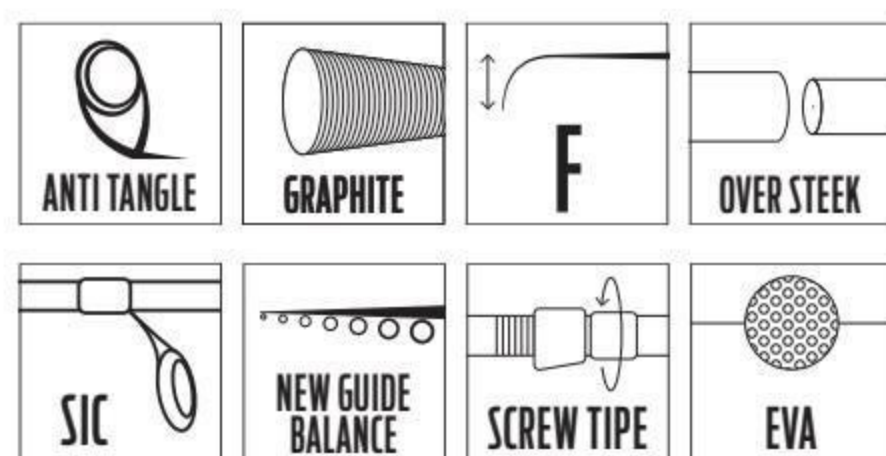

ITEM NO.	LENGTH (FT/M)	WEIGHT (G)	CLASS	ACTION	CASTING WEIGHT (G)	SECTIONS	TRANSP. LENGTH (CM)
LJPP-822HF	8,2/2,48	140	Heavy	Fast	15-56	2	129
LJPP-902HF	9,0/2,74	173	Heavy	Fast	15-56	2	142

## SPINNING ROD **PROGRESS POWERJIG 80**

Powerful spinning rod for fishing with heavy jigs. Durability and sensitivity are the main features of this rod.

### BLANK:

- Material – carbon fiber **(30T)**
- Action – **fast F**
- Class – **heavy H**
- Joint type – **OVER STEEK**
- Loop shape hook keeper

### HANDLE:

- Material – hard **EVA**
- Screw type reel seat

### GUIDES:

- Anti-tangle
- **SIC** inserts

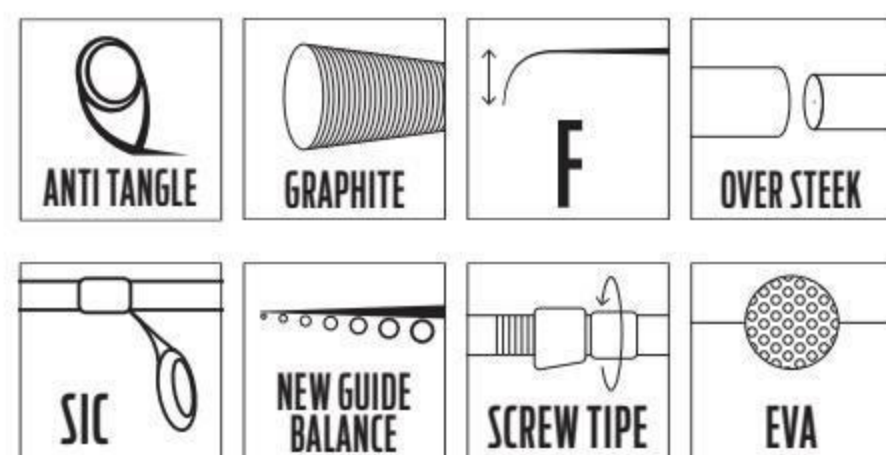

ITEM NO.	LENGTH (FT/M)	WEIGHT (G)	CLASS	ACTION	CASTING WEIGHT (G)	SECTIONS	TRANSP. LENGTH (CM)
LJPP-852HEF	8,5/2,57	122	Heavy	Fast	30-80	2	134
LJPP-902HEF	9,0/2,74	187	Heavy	Fast	30-80	2	142

## LUCKY JOHN SPINNING RODS VANREX SERIES

ITEM NO.	SERIES	MODEL	BLANK MATERIAL	ACTION	LENGTH (FT/M)	WEIGHT (G)	CASTING WEIGHT (G)	SECTIONS	TRANSP. LENGTH (CM)
LJVFG-702LMF	Vanrex	FINESS GAME	Carbon fiber	Medium-Fast	7'0"/2,13	100	3-9	2	110
LJVFG-762LMF	Vanrex	FINESS GAME	Carbon fiber	Medium-Fast	7'6"/2,28	104	3-9	2	118
LJVJ-662LMF	Vanrex	MICROJIG 9	Carbon fiber	Fast	6,6/1,98	88	2-9	2	104
LJVJ-702LMF	Vanrex	MICROJIG 9	Carbon fiber	Fast	7,0/2,13	93	2-9	2	110
LJVJ-762LMF	Vanrex	MICROJIG 9	Carbon fiber	Fast	7,6/2,28	99	2-9	2	118
LJVJ-702LF	Vanrex	JIG 14	Carbon fiber	Fast	7,0/2,13	99	3-14	2	110
LJVJ-762LF	Vanrex	JIG 14	Carbon fiber	Medium-Fast	7,6/2,28	109	3-14	2	118
LJVJ-802LF	Vanrex	JIG 14	Carbon fiber	Medium-Fast	8,0/2,44	113	3-14	2	124
LJVJ-702MLF	Vanrex	JIG 21	Carbon fiber	Fast	7,0/2,13	106	5-21	2	110
LJVJ-762MLF	Vanrex	JIG 21	Carbon fiber	Fast	7,6/2,28	118	5-21	2	118
LJVJ-802MLF	Vanrex	JIG 21	Carbon fiber	Fast	8,0/2,44	120	5-21	2	124
LJVJ-882MLF	Vanrex	JIG 21	Carbon fiber	Fast	8,8/2,65	139	5-21	2	135
LJVA-742LF	Vanrex	VANREX 15	Carbon fiber	Fast	7,4/2,23	116	3-15	2	115
LJVA-702MLF	Vanrex	VANREX 21	Carbon fiber	Fast	7,0/2,13	119	5-21	2	110,5
LJVA-762MLF	Vanrex	VANREX 21	Carbon fiber	Fast	7,6/2,28	127	5-21	2	118
LJVA-742MF	Vanrex	VANREX 28	Carbon fiber	Fast	7,4/2,33	124	7-28	2	115
LJVA-802MF	Vanrex	VANREX 28	Carbon fiber	Fast	8,0/2,44	143	7-28	2	126
LJVA-902MF	Vanrex	VANREX 28	Carbon fiber	Fast	9,0/2,74	167	7-28	2	142
LJVT-662LEF	Vanrex	TWITCHING 14	Carbon fiber	Fast	6,6/1,98	99	3-14	2	104
LJVT-742LEF	Vanrex	TWITCHING 14	Carbon fiber	Fast	7,4/2,23	116	3-14	2	115
LJVT-662MLEF	Vanrex	TWITCHING 21	Carbon fiber	Fast	6,6/1,98	106	5-21	2	104
LJVT-742MLEF	Vanrex	TWITCHING 21	Carbon fiber	Fast	7,4/2,23	118	5-21	2	115
LJVT-662MEF	Vanrex	TWITCHING 28	Carbon fiber	Fast	6,6/1,98	114	7-28	2	104
LJVT-742MEF	Vanrex	TWITCHING 28	Carbon fiber	Fast	7,4/2,23	126	7-28	2	115
LJVT-742MHEF	Vanrex	TWITCHING 42	Carbon fiber	Extra fast	7,4/2,23	135	10-42	2	115
LJVB-662LF	Vanrex	BAITCAST 14	Carbon fiber	Fast	6,6/1,98	104	3-14	2	104
LJVB-762LF	Vanrex	BAITCAST 14	Carbon fiber	Fast	7,6/2,28	120	3-14	2	118
LJVB-662MLF	Vanrex	BAITCAST 21	Carbon fiber	Fast	6,6/1,98	116	5-21	2	104
LJVB-762MLF	Vanrex	BAITCAST 21	Carbon fiber	Fast	7,6/2,28	131	5-21	2	118
LJVB-662MF	Vanrex	BAITCAST 28	Carbon fiber	Fast	6,6/1,98	122	7-28	2	104
LJVB-762MF	Vanrex	BAITCAST 28	Carbon fiber	Fast	7,6/2,28	138	7-28	2	118
LJVJ-804MLF	Vanrex	JIG TRAVEL 21	Carbon fiber	Fast	8,0/2,44	122	5-21	4	66

### SPINNING ROD VANREX FINESS GAME

Modern spinning rod for jigging technique.

#### BLANK:

- Material – carbon fibre **(30T)**
- Action – **medium fast MF**
- Class – **light L**
- Joint type – **OVER STEEK**

#### HANDLE:

- Material – hard **EVA**
- Screw type reel seat

#### GUIDES

- Lightweight
- **SIC** inserts

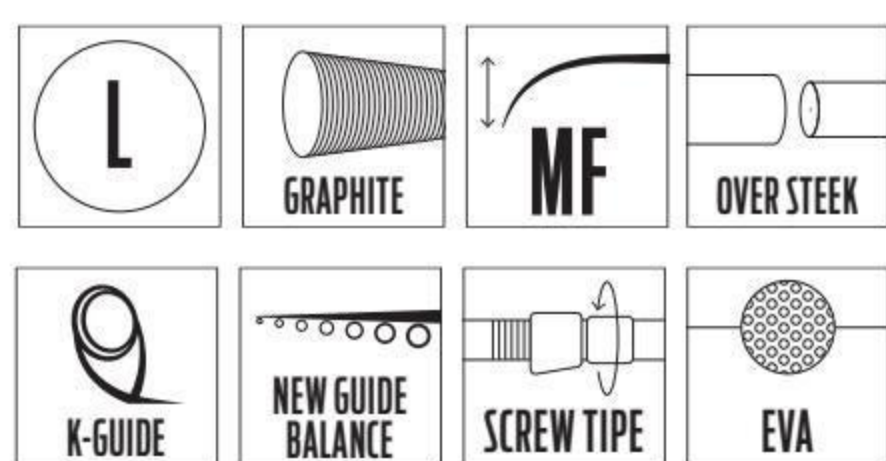

ITEM NO.	LENGTH (FT/M)	WEIGHT (G)	CLASS	ACTION	CASTING WEIGHT (G)	SECTIONS	TRANSP. LENGTH (CM)
LJVFG-702LMF	7'0"/2,13	100	Light	Medium fast	3-9	2	110
LJVFG-762LMF	7'6"/2,28	104	Light	Medium fast	3-9	2	118

## SPINNING ROD VANREX MICROJIG 9

Modern spinning rod for micro-jigging. Excellent combination of price and quality.

### BLANK:

- Material – carbon fiber **(30T)**
- Action – **fast F**
- Class – **light L**
- Joint type – **OVER STEEK**

### HANDLE:

- Material – hard **EVA**
- Screw type reel seat

### GUIDES:

- Lightweight
- **SIC** inserts

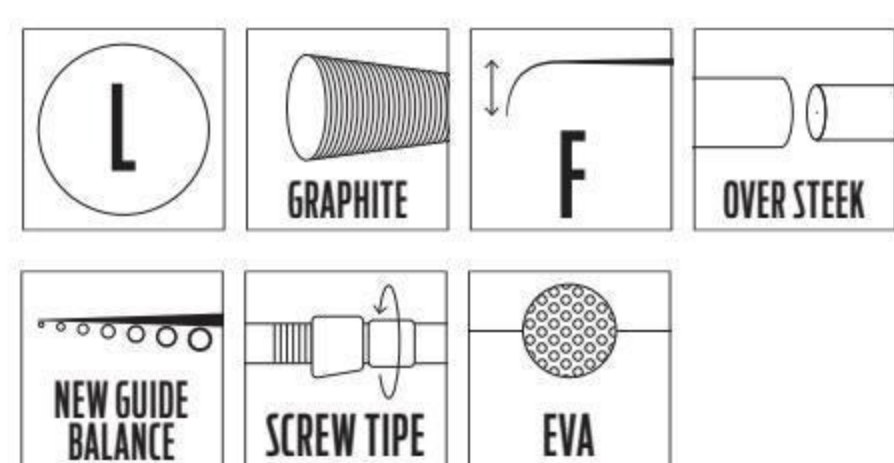

ITEM NO.	LENGTH (FT/M)	WEIGHT (G)	CLASS	ACTION	CASTING WEIGHT (G)	SECTIONS	TRANSP. LENGTH (CM)
LJVJ-662LMF	6,6/1,98	88	Light	Fast	2-9	2	104
LJVJ-702LMF	7,0/2,13	93	Light	Fast	2-9	2	110
LJVJ-762LMF	7,6/2,28	99	Light	Fast	2-9	2	118

## SPINNING ROD VANREX JIG 14

Modern spinning rod for jigging. Excellent combination of price and quality.

### BLANK:

- Material – carbon fiber **(30T)**
- Action – **fast F**
- Class – **light L**
- Joint type – **OVER STEEK**

### HANDLE:

- Material – hard **EVA**
- Screw type reel seat

### GUIDES:

- Lightweight
- **SIC** inserts

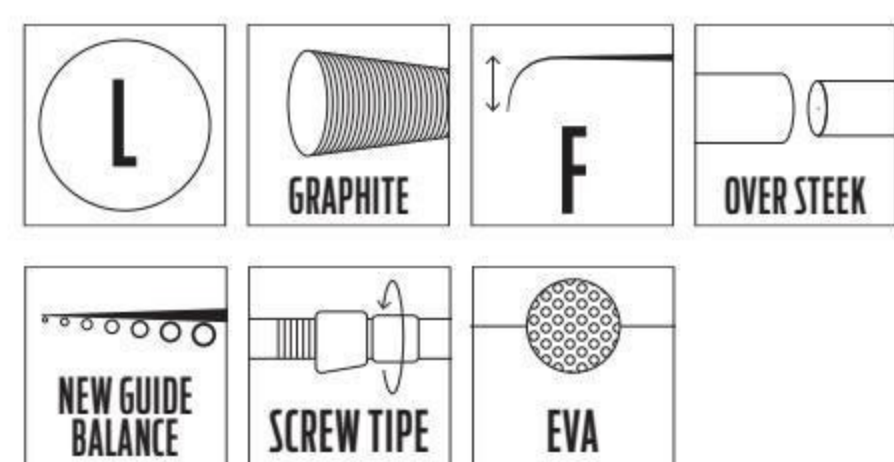

ITEM NO.	LENGTH (FT/M)	WEIGHT (G)	CLASS	ACTION	CASTING WEIGHT (G)	SECTIONS	TRANSP. LENGTH (CM)
LJVJ-702LF	7,0/2,13	99	Light	Fast	3-14	2	110
LJVJ-762LF	7,6/2,28	109	Light	Fast	3-14	2	118
LJVJ-802LF	8,0/2,44	113	Light	Fast	3-14	2	124

## SPINNING ROD VANREX JIG 21

Modern spinning rod for jigging. Excellent combination of price and quality.

### BLANK:

- Material – carbon fiber (30T)
- Action – **fast F**
- Class – **medium light ML**
- Joint type – **OVER STEEK**

### HANDLE:

- Material – hard **EVA**
- Screw type reel seat

### GUIDES:

- Lightweight
- **SIC** inserts

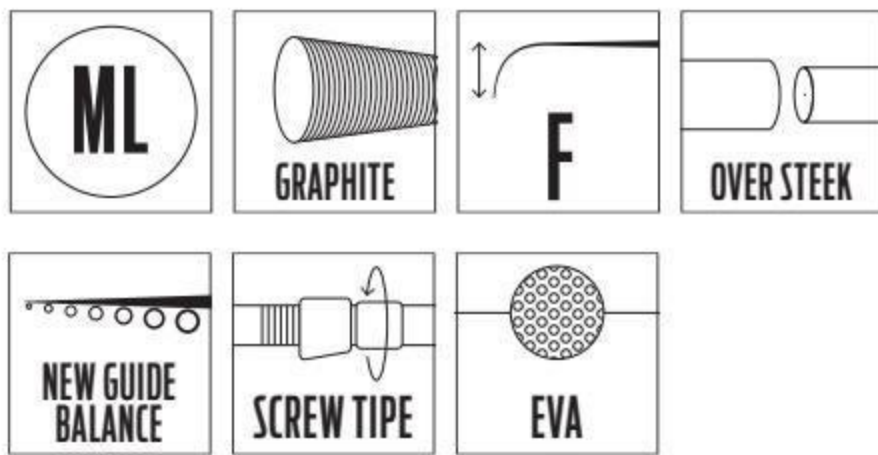

ITEM NO.	LENGTH (FT/M)	WEIGHT (G)	CLASS	ACTION	CASTING WEIGHT (G)	SECTIONS	TRANSP. LENGTH (CM)
LJVJ-702MLF	7,0/2,13	106	M-Light	Fast	5-21	2	110
LJVJ-762MLF	7,6/2,28	118	M-Light	Fast	5-21	2	118
LJVJ-802MLF	8,0/2,44	120	M-Light	Fast	5-21	2	124
LJVJ-882MLF	8,8/2,65	139	M-Light	Fast	5-21	2	135

## SPINNING ROD VANREX 15

Universal spinning rod, suitable for the most popular spinning techniques. The rod is equipped with a very comfortable “warm” Lucky John reel seat.

### BLANK:

- Material – carbon fiber (30T)
- Action – **fast F**
- Class – **light L**
- Joint type – **OVER STEEK**

### HANDLE:

- Material – hard **EVA**
- Screw type reel seat

### GUIDES:

- Lightweight
- Anti-tangle
- **SIC** inserts



ITEM NO.	LENGTH (FT/M)	WEIGHT (G)	CLASS	ACTION	CASTING WEIGHT (G)	SECTIONS	TRANSP. LENGTH (CM)
LJVA-742LF	7,4/2,23	116	Light	Fast	3-15	2	115



## SPINNING ROD VANREX 21

Universal spinning rod, suitable for the most popular spinning techniques. The rod is equipped with a very comfortable “warm” Lucky John reel seat.

### BLANK:

- Material – carbon fiber **(30T)**
- Action – **fast F**
- Class – **medium light ML**
- Joint type – **OVER STEEK**

### HANDLE:

- Material – hard **EVA**
- Screw type reel seat

### GUIDES:

- Lightweight
- Anti-tangle
- **SIC** inserts

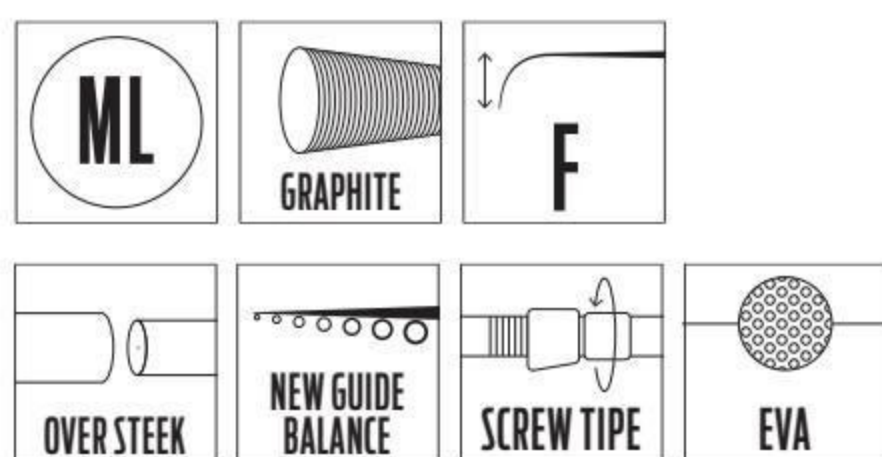

ITEM NO.	LENGTH (FT/M)	WEIGHT (G)	CLASS	ACTION	CASTING WEIGHT (G)	SECTIONS	TRANSP. LENGTH (CM)
LJVA-702MLF	7,0/2,13	119	M-Light	Fast	5-21	2	110,5
LJVA-762MLF	7,6/2,28	127	M-Light	Fast	5-21	2	118

## SPINNING ROD VANREX 28

Universal spinning rod, suitable for the most popular spinning techniques. The rod is equipped with a very comfortable “warm” Lucky John reel seat.

### BLANK:

- Material – carbon fiber **(30T)**
- Action – **fast F**
- Class – **medium M**
- Joint type – **OVER STEEK**

### HANDLE:

- Material – hard **EVA**
- Screw type reel seat

### GUIDES:

- Lightweight
- Anti-tangle
- **SIC** inserts

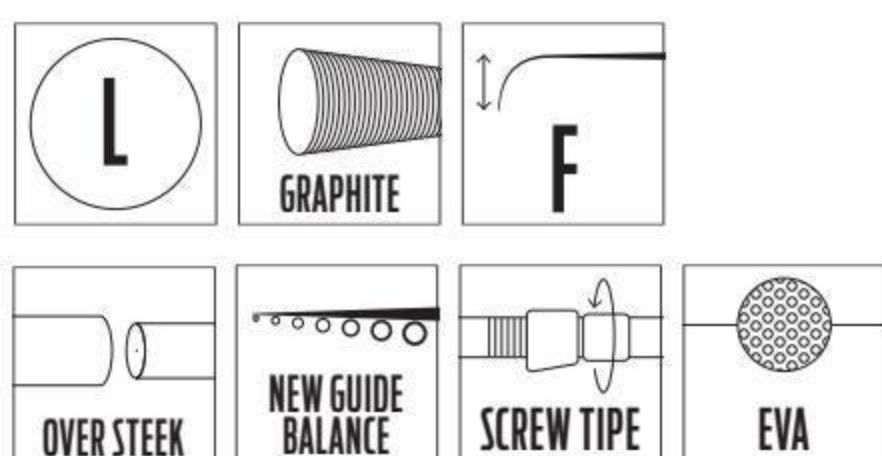

ITEM NO.	LENGTH (FT/M)	WEIGHT (G)	CLASS	ACTION	CASTING WEIGHT (G)	SECTIONS	TRANSP. LENGTH (CM)
LJVA-742MF	7,4/2,23	124	Medium	Fast	7-28	2	115
LJVA-802MF	8,0/2,44	143	Medium	Fast	7-28	2	126
LJVA-902MF	9,0/2,74	167	Medium	Fast	7-28	2	142

## SPINNING ROD VANREX TWITCHING 14

Spinning rod, perfect for twitching technique. Fast, functional, and sensitive rod. Excellent combination of price and quality.

**BLANK:**

- Material – carbon fiber **(30T)**
- Action – **fast F**
- Class – **light L**
- Joint type – **OVER STEEK**

**HANDLE:**

- Material – hard **EVA**
- Screw type reel seat

**GUIDES:**

- Anti-tangle
- **SIC** inserts

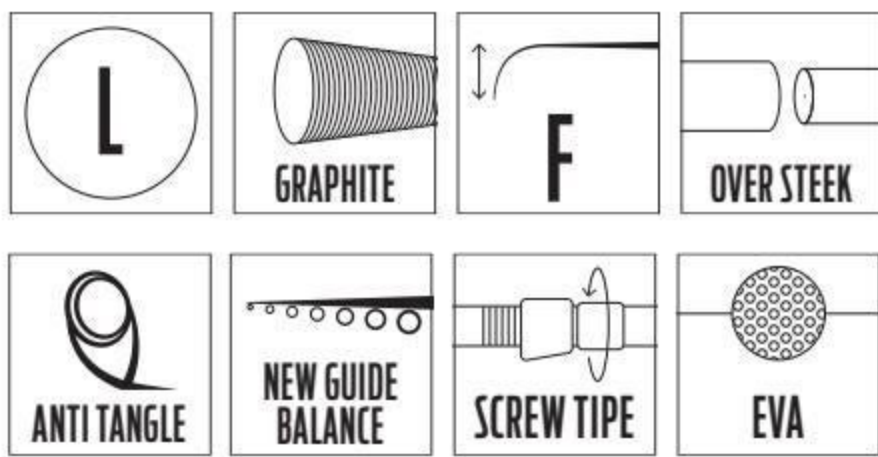

ITEM NO.	LENGTH (FT/M)	WEIGHT (G)	CLASS	ACTION	CASTING WEIGHT (G)	SECTIONS	TRANSP. LENGTH (CM)
LJVT-662LEF	6,6/1,98	99	Light	Fast	3-14	2	104
LJVT-742LEF	7,4/2,23	116	Light	Fast	3-14	2	115

## SPINNING ROD VANREX TWITCHING 21

Spinning rod, perfect for twitching technique. Fast, functional, and sensitive rod. Excellent combination of price and quality.

**BLANK:**

- Material – carbon fiber **(30T)**
- Action – **extra fast EF**
- Class – **medium light ML**
- Joint type – **OVER STEEK**

**HANDLE:**

- Material – hard **EVA**
- Screw type reel seat

**GUIDES:**

- Anti-tangle
- **SIC** inserts

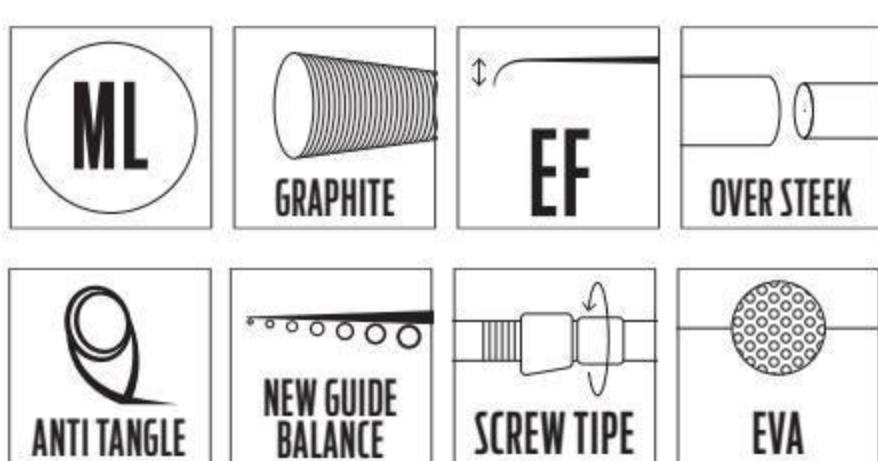

ITEM NO.	LENGTH (FT/M)	WEIGHT (G)	CLASS	ACTION	CASTING WEIGHT (G)	SECTIONS	TRANSP. LENGTH (CM)
LJVT-662MLEF	6,6/1,98	106	M-Light	Extra fast	5-21	2	104
LJVT-742MLEF	7,4/2,23	118	M-Light	Extra fast	5-21	2	115

## SPINNING ROD VANREX TWITCHING 28

Spinning rod, perfect for twitching technique. Fast, functional, and sensitive rod. Excellent combination of price and quality.

### BLANK:

- Material – carbon fiber **(30T)**
- Action – **extra fast EF**
- Class – **medium M**
- Joint type – **OVER STEEK**

### HANDLE:

- Material – hard **EVA**
- Screw type reel seat

### GUIDES:

- Anti-tangle
- **SIC** inserts

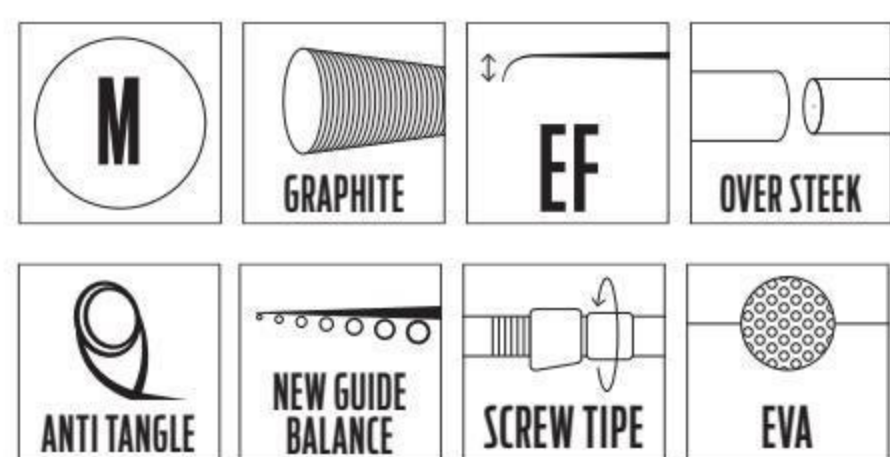

ITEM NO.	LENGTH (FT/M)	WEIGHT (G)	CLASS	ACTION	CASTING WEIGHT (G)	SECTIONS	TRANSP. LENGTH (CM)
LJVT-662MEF	6,6/1,98	114	Medium	Extra fast	7-28	2	104
LJVT-742MEF	7,4/2,23	126	Medium	Extra fast	7-28	2	115

## SPINNING ROD VANREX TWITCHING 42

Spinning rod, perfect for twitching with large lures. Fast, functional, and sensitive rod. Excellent combination of price and quality.

### BLANK:

- Material – carbon fiber **(30T)**
- Action – **extra fast EF**
- Class – **medium heavy MH**
- Joint type – **OVER STEEK**

### HANDLE:

- Material – hard **EVA**
- Screw type reel seat

### GUIDES:

- Anti-tangle
- **SIC** inserts

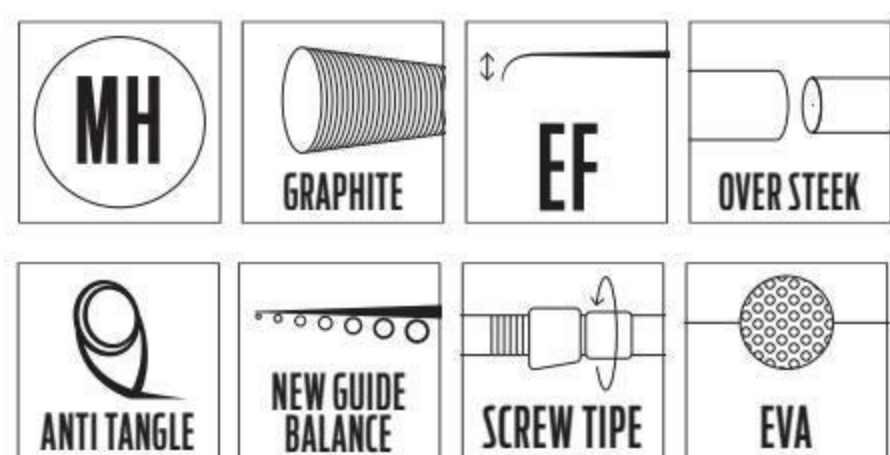

ITEM NO.	LENGTH (FT/M)	WEIGHT (G)	CLASS	ACTION	CASTING WEIGHT (G)	SECTIONS	TRANSP. LENGTH (CM)
LJVT-662MHEF	6,6/1,98	120	Medium heavy	Extra fast	10-42	2	104
LJVT-742MHEF	7,4/2,23	135	Medium heavy	Extra fast	10-42	2	115

## SPINNING ROD VANREX BAITCAST 14

Modern spinning rod for fishing with a multiplier (baitcasting) reel. Powerful and sensitive rod. Excellent combination of price and quality.

**BLANK:**

- Material – carbon fiber **(30T)**
- Action – **fast F**
- Class – **light L**
- Joint type – **OVER STEEK**

**HANDLE:**

- Material – hard **EVA**
- Screw type reel seat

**GUIDES:**

- **SIC** inserts

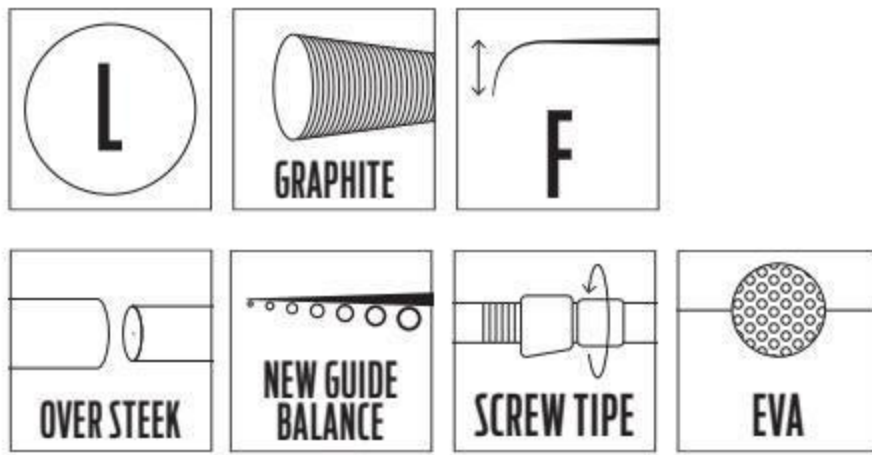

ITEM NO.	LENGTH (FT/M)	WEIGHT (G)	CLASS	ACTION	CASTING WEIGHT (G)	SECTIONS	TRANSP. LENGTH (CM)
LJVB-662LF	6,6/1,98	104	Light	Fast	3-14	2	104
LJVB-762LF	7,6/2,28	120	Light	Fast	3-14	2	118

## SPINNING ROD VANREX BAITCAST 21

Modern spinning rod for fishing with a multiplier (baitcasting) reel. Powerful and sensitive rod. Excellent combination of price and quality.

**BLANK:**

- Material – carbon fiber **(30T)**
- Action – **fast F**
- Class – **medium light ML**
- Joint type – **OVER STEEK**

**HANDLE:**

- Material – hard **EVA**
- Screw type reel seat

**GUIDES:**

- **SIC** inserts

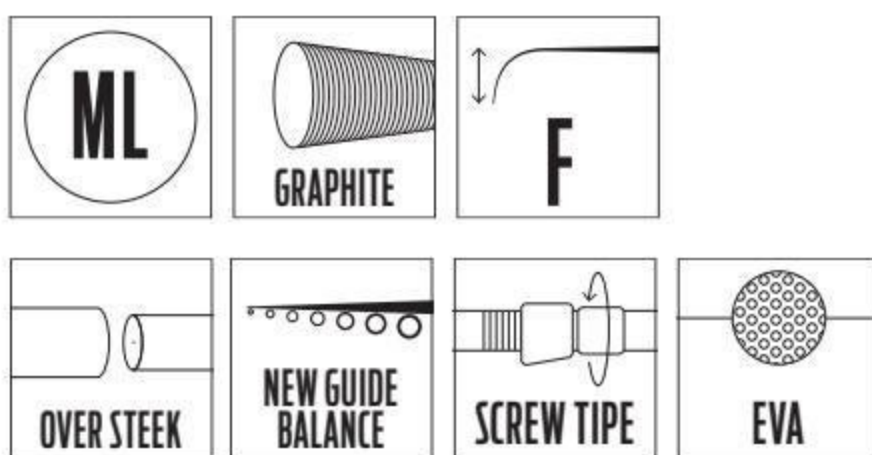

ITEM NO.	LENGTH (FT/M)	WEIGHT (G)	CLASS	ACTION	CASTING WEIGHT (G)	SECTIONS	TRANSP. LENGTH (CM)
LJVB-662MLF	6,6/1,98	116	M-Light	Fast	5-21	2	104
LJVB-762MLF	7,6/2,28	131	M-Light	Fast	5-21	2	118

## SPINNING ROD VANREX BAITCAST 28

Modern spinning rod for fishing with a multiplier (baitcasting) reel. Powerful and sensitive rod. Excellent combination of price and quality.

### BLANK:

- Material – carbon fiber **(30T)**
- Action – **fast F**
- Class – **medium M**
- Joint type – **OVER STEEK**

### HANDLE:

- Material – hard **EVA**
- Screw type reel seat

### GUIDES:

- **SIC** inserts

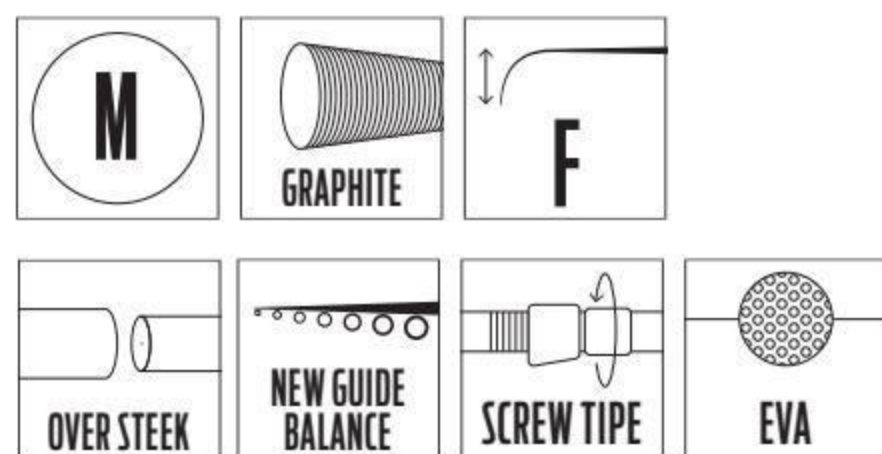

ITEM NO.	LENGTH (FT/M)	WEIGHT (G)	CLASS	ACTION	CASTING WEIGHT (G)	SECTIONS	TRANSP. LENGTH (CM)
LJVB-662MF	6,6/1,98	122	Medium	Fast	7-28	2	104
LJVB-762MF	7,6/2,28	138	Medium	Fast	7-28	2	118

## SPINNING ROD VANREX JIG TRAVEL 21

### BLANK:

- Material – carbon fiber **(30T)**
- Action – **fast F**
- Class – **medium light ML**
- Joint type – **OVER STEEK**

### HANDLE:

- Material (hard) **EVA**
- Screw type reel seat

### GUIDES:

- Light weight
- AT-GUIDE
- **SIC** inserts

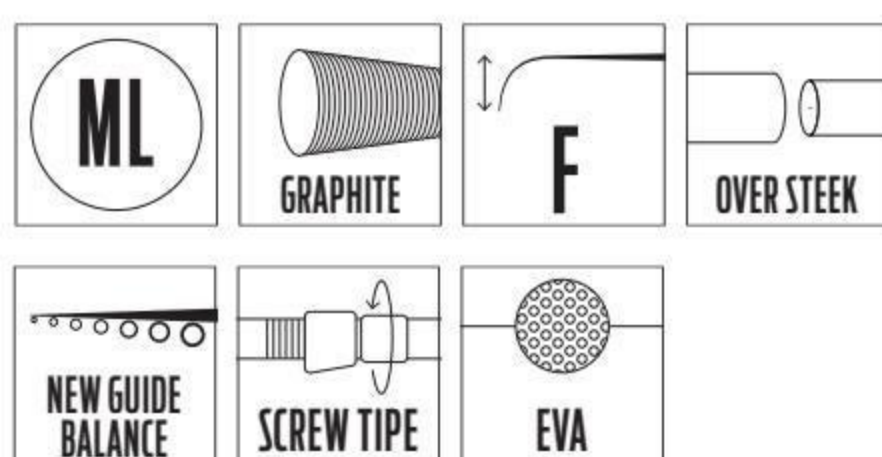

ITEM NO.	LENGTH (FT/M)	WEIGHT (G)	CLASS	ACTION	CASTING WEIGHT (G)	SECTIONS	TRANSP. LENGTH (CM)
LJVJ-804MLF	8,0/2,44	122	ML	F	5-21	4	66

## LUCKY JOHN SPINNING RODS AREA TROUT GAME SERIES

### SPINNING ROD ONE SENSORIC AREA TROUT GAME

Medium action 2 section high class spinning rod, developed specifically for area fishing.

**BLANK:**

- Material - carbon fiber (40T)
- Action - **medium M**
- Class - **ultra light UL**
- Joint type - **OVER STEEK**

**HANDLE:**

- Material - AAA class cork
- Screw type **FUJI** reel seat

**GUIDES:**

- Type - **FUJI KR** Torzite

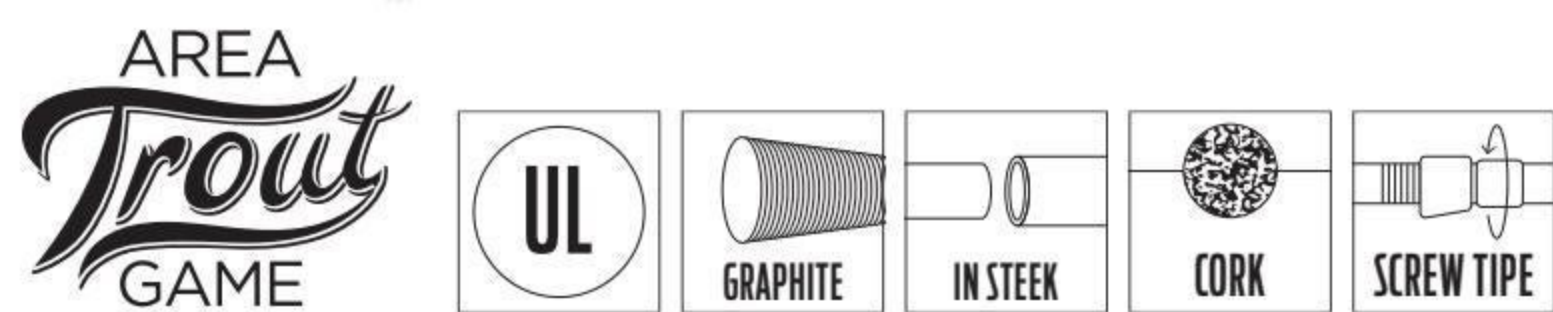

ITEM NO.	LENGTH (FT/M)	WEIGHT (G)	CLASS	ACTION	CASTING WEIGHT (G)	SECTIONS	TRANSP. LENGTH (CM)
LJOS-602LM	6/1,83	U-Light	70	Medium	1-4	2	95

### SPINNING ROD ATG ARCO 03

Medium action, ultra-light class 2 section spinning rod specially designed for area fishing.

**BLANK:**

- Material - carbon fiber (30T)
- Action - **medium M**
- Class - **ultra light UL**
- Joint type - **OVER STEEK**

**HANDLE:**

- Material - AAA class cork
- Screw type reel seat

**GUIDES:**

- Lightweight
- **SIC** inserts

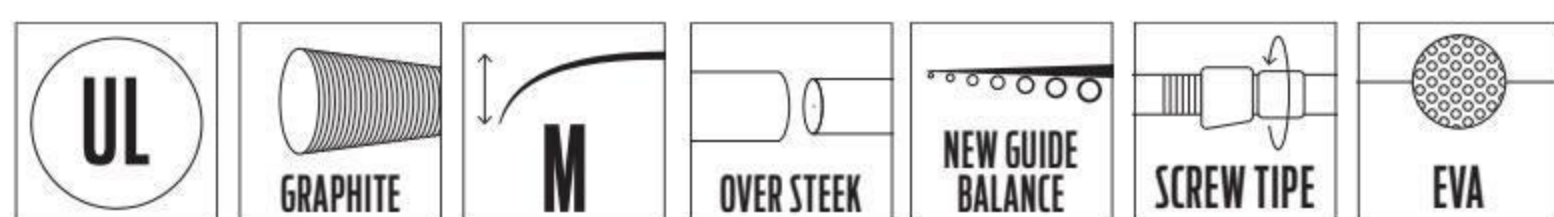

ITEM NO.	LENGTH (FT/M)	WEIGHT (G)	CLASS	ACTION	CASTING WEIGHT (G)	SECTIONS	TRANSP. LENGTH (CM)
LJATAR-602ULM	6,0/1,83	59	UL	M	0,5-3	2	95

### SPINNING ROD ATG INTOX 04/05

Light and functional high-quality spinning rod.

**BLANK:**

- Material - carbon fiber (30T)
- Action - **medium fast MF**
- Class - **ultra light UL**
- Joint type - **OVER STEEK**

**HANDLE:**

- Material - hard **EVA**
- Screw type reel seat

**GUIDES:**

- Anti-tangle
- **SIC** inserts

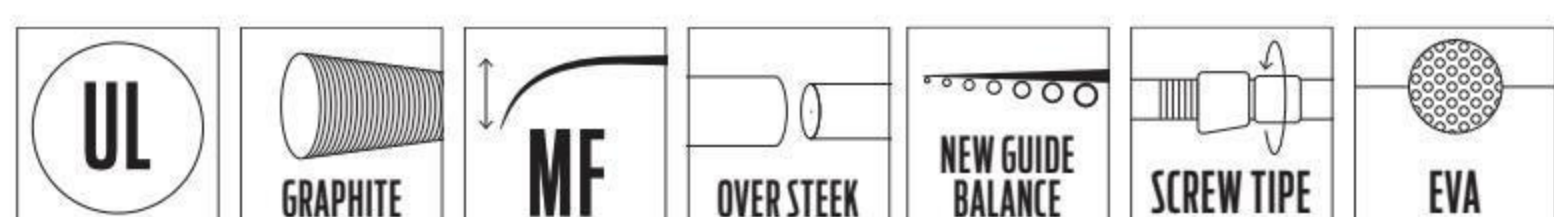

ITEM NO.	LENGTH (FT/M)	WEIGHT (G)	CLASS	ACTION	CASTING WEIGHT (G)	SECTIONS	TRANSP. LENGTH (CM)
LJATIN-602ULMF	6,0/1,83	85	UL	MF	1-4	2	94
LJATIN-662ULMF	6,6/1,98	90	UL	MF	1,5-5	2	101



LUCKY JOHN  
SUMMER

FEEDER  
CONCEPT

NORFIN  
SUMMER

LUCKY JOHN  
WINTER

NORFIN  
WINTER

MARKETING  
MATERIALS

## BRAIDED FISHING LINE VANREX X4

A modern 4-strand braided fishing line made of PE fibre. The round cross section of the line in combination with a smooth and "slippery" surface provides a long casting distance of the bait: jig head, wobbler or a spinner. High braid density and increased durability allow the line to be used in all seasons. Supplied in individual package – 125 m length. Excellent combination of price and quality.

- High abrasion resistance
- Round cross section
- Increased durability
- Maximum casting distance
- All-season usage
- Fluo orange color

ITEM NO.	DIAM. (MM)	LENGTH (M)	COLOR	Q-TY IN PACKAGE
LJ4113-008	0,08	125	Fluo orange	ind. pack.
LJ4113-010	0,10	125	Fluo orange	ind. pack.
LJ4113-012	0,12	125	Fluo orange	ind. pack.
LJ4113-014	0,14	125	Fluo orange	ind. pack.
LJ4113-017	0,17	125	Fluo orange	ind. pack.
LJ4113-020	0,20	125	Fluo orange	ind. pack.

ITEM NO.	DIAM. (MM)	LENGTH (M)	COLOR	Q-TY IN PACKAGE
LJ4114-008	0,08	125	Moss Green	ind. pack.
LJ4114-010	0,10	125	Moss Green	ind. pack.
LJ4114-012	0,12	125	Moss Green	ind. pack.
LJ4114-014	0,14	125	Moss Green	ind. pack.
LJ4114-017	0,17	125	Moss Green	ind. pack.
LJ4114-020	0,20	125	Moss Green	ind. pack.
LJ4114-028	0,28	125	Moss Green	ind. pack.
LJ4114-032	0,32	125	Moss Green	ind. pack.
LJ4114-037	0,37	125	Moss Green	ind. pack.
LJ4114-040	0,40	125	Moss Green	ind. pack.
LJ4114-045	0,45	125	Moss Green	ind. pack.

**NEW**  
**NEW**

## BRAIDED FISHING LINE VANREX EGI & JIGGING X4 MULTI COLOR

**NEW**

Multi-colored fishing line, perfect for jig fishing. The color changes every ten meters, which provides good visual control of the cast. After each meter there is a white mark on the line, which allows to determine precise casting distance.

- high durability
- low stretch ratio
- high sensitivity
- increased casting distance
- enhanced wear-resistance
- all-season usage
- multi-color



**STRENGTH TABLE**

Diameter (mm)	0,08	0,10	0,12	0,14	0,17
Test (kg)	2,50	3,40	5,10	6,20	7,30

ITEM NO.	DIAM. (MM)	LENGTH (M)	COLOR	Q-TY IN PACKAGE
LJ4108-010	0,10	150	multicolor	ind. pack.
LJ4108-012	0,12	150	multicolor	ind. pack.
LJ4108-014	0,14	150	multicolor	ind. pack.
LJ4108-017	0,17	150	multicolor	ind. pack.

**BBS**  
BIG BAIT SERIES



**STRENGTH TABLE**

Diameter (mm)	0,08	0,10	0,12	0,14	0,17	0,20	0,28	0,32	0,37	0,40	0,45
Test (kg)	2,50	3,40	5,10	6,20	7,30	9,10	14,1	18,2	21,8	25,00	29,50

## BRAIDED FISHING LINE AREA TROUT GAME X4 PINK

**NEW**

Specialized thin braided line for area trout fishing. 4-strand braided fishing line made of PE fibre. Due to the cross-section and special coating, the line perfectly slides through the guides, allowing to cast small baits for long distances. Pink color in combination with thin diameters does not frighten trout and the number of bites increases.

- high durability
- low stretch ratio
- high sensitivity
- increased casting distance
- enhanced wear-resistance
- all-season usage
- color – pink



**STRENGTH TABLE**

Diameter (mm)	0,08	0,10	0,12
Test (kg)	2,50	3,40	5,10

ITEM NO.	DIAM. (MM)	LENGTH (M)	COLOR	Q-TY IN PACKAGE
LJ4110-008	0,08	125	pink	ind. pack.
LJ4110-010	0,10	125	pink	ind. pack.
LJ4110-012	0,12	125	pink	ind. pack.



## BRAIDED FISHING LINE VANREX X8

A modern 8-strand braided fishing line made of PE fibre. The round cross section of the line in combination with a smooth and “slippery” surface provides a long casting distance of the bait: jig head, wobbler or a spinner. High braid density and increased durability allow the line to be used in all seasons. Supplied in individual package – 125 m length. Excellent combination of price and quality.

- High sensitivity
- Round cross section
- Durable at the knots
- Maximum casting distance
- All-season usage
- Fluo green color



ITEM NO.	DIAM. (MM)	LENGTH (M)	COLOR	Q-TY IN PACKAGE
LJ4118-012	0,12	125	Fluo Green	ind. pack.
LJ4118-014	0,14	125	Fluo Green	ind. pack.
LJ4118-016	0,16	125	Fluo Green	ind. pack.
LJ4118-018	0,18	125	Fluo Green	ind. pack.
LJ4118-020	0,20	125	Fluo Green	ind. pack.



STRENGTH TABLE

Diameter (mm)	0,12	0,14	0,16	0,18	0,20
Test (kg)	5,20	6,30	7,50	9,30	10,05

## MONOFILAMENT FISHING LINE FLUOROCARBON HARD

Fast sinking (specific weight – 1,78g/cm<sup>2</sup>) durable fishing line designed for tying leaders and shock leaders. Fluorocarbon is invisible in water, does not absorb water and retains its durability for a long period. Low linear stretching ability prevents the thinning of fishing line and retains its durability, which allows making a stiff strike. Supplied in individual package – 30 m length. Produced in Japan.

- 100% fluorocarbon
- Fast sinking
- Invisible in water
- High sensitivity
- Zero water absorption
- Enhanced wear-resistance
- Durable at the knot
- Transparent colorless fishing line



STRENGTH TABLE

Diameter, mm	0,148	0,165	0,180	0,205	0,235	0,260	0,285	0,310
Size #	0,8	1,0	1,0	1,5	2,0	2,5	3,0	3,5
Test (kg)	1,84	2,26	2,09	3,05	4,14	5,06	6,32	7,17
Test (lb)	4	5	2,09	7	9	11	14	16

ITEM NO.	DIAM. (MM)	#	LENGTH (M)	COLOR	Q-TY IN PACKAGE
LJ4051-014	0,148	0,8	30	transparent	ind. pack.
LJ4051-016	0,165	1,0	30	transparent	ind. pack.
LJ4051-018	0,180	1,0	30	transparent	ind. pack.
LJ4051-020	0,205	1,5	30	transparent	ind. pack.
LJ4051-023	0,235	2,0	30	transparent	ind. pack.
LJ4051-026	0,260	2,5	30	transparent	ind. pack.
LJ4051-028	0,285	3,0	30	transparent	ind. pack.
LJ4051-031	0,310	3,5	30	transparent	ind. pack.

## MONOFILAMENT FISHING LINE FLUOROCARBON SOFT

Fast-sinking (specific weight – 1,78 g/cm<sup>3</sup>) durable fishing line. Fluorocarbon is invisible in water (light refraction angle is the same as with water), does not absorb water and retains its durability for a long period. Low linear stretching ability prevents the thinning of fishing line and retains its durability, which allows making a stiff strike. The fishing line is unreeled onto high-tech doughnut spools of 100 metres. The fishing line is produced and unreeled at a specialised factory in Japan.

- 100% fluorocarbon
- Fast sinking
- Invisible in water
- High sensitivity
- Zero water absorption
- Enhanced wear-resistance
- Durable at the knot
- Transparent colorless fishing line



STRENGTH TABLE

Diameter (mm)	0,161	0,180	0,201	0,234	0,257	0,283
Test (kg)	1,76	2,20	2,80	3,79	4,57	5,55

ITEM NO.	DIAM. (MM)	#	LENGTH (M)	COLOR	Q-TY IN PACKAGE
LJ4049-016	0,161	0,8	100	transparent	ind. pack.
LJ4049-018	0,180	1,0	100	transparent	ind. pack.
LJ4049-020	0,201	1,2	100	transparent	ind. pack.
LJ4049-023	0,234	1,75	100	transparent	ind. pack.
LJ4049-025	0,257	2,0	100	transparent	ind. pack.
LJ4049-028	0,283	2,5	100	transparent	ind. pack.

## LANDING NETS

### LANDING NET



ITEM NO.	LENGTH (CM)	HEAD SIZE (CM)	CELL (CM)	MATERIAL
LJ-7358-063	63	42 x 33	4,0 x 4,0	silicone

### FOLDING TELESCOPIC LANDING NET

Folding telescopic landing net made of rubberized polyester. This material is less traumatic to the fish and prevents the hook from getting caught in the net.



ITEM NO.	TRANSP. LENGTH (CM)	LENGTH (CM)	HEAD SIZE (CM)	CELL (CM)	MATERIAL
LJ-7354-220	128	220	50 x 48	4,0 x 4,0	polyester rubberized

### FOLDING TELESCOPIC LANDING NET

Large telescopic landing net with folding triangular head.



ITEM NO.	TRANSP. LENGTH (CM)	LENGTH (CM)	HEAD SIZE (CM)	CELL (CM)	MATERIAL
LJ-7070-200	85	200	63 x 63	3,5 x 3,5	tennis cord
LJ-7070-250	85	250	70 x 70	3,5 x 3,5	tennis cord

### FOLDING LANDING NET

Folding landing net. Suitable for trout sport fishing, as the net soft silicone material does not injure the trout and allows it to be released back into the water.



ITEM NO.	TRANSP. LENGTH (CM)	LENGTH (CM)	HEAD SIZE (CM)	CELL (CM)	MATERIAL
LJAT-7069-115	73	115	35 x 45	2,2 x 2,2	silicone

### LANDING NET

Large folding landing net with a round head.



ITEM NO.	TRANSP. LENGTH (CM)	LENGTH (CM)	HEAD SIZE (CM)	CELL (CM)	MATERIAL
LJ-7349-185	128	185	50 x 48	4 x 4	Tennis cord
LJ-7352-185	115	185	60 x 70	4,0 x 4,0	Tennis cord
LJ-7353-215	135	215	70 x 80	4,0 x 4,0	Tennis cord

## FOLDING LANDING NET

Folding landing net made of rubberized polyester. This material is less traumatic to the fish and prevents the hook from getting caught in the net. Powerful handle.



ITEM NO.	TRANSP. LENGTH (CM)	LENGTH (CM)	HEAD SIZE (CM)	CELL (CM)	MATERIAL
LJ-7357-090	48	90	42 x 35	0,8 x 0,6	polyester rubberized

## FOLDING LANDING NET

Folding landing net made of rubberized polyester. This material is less traumatic to the fish and prevents the hook from getting caught in the net. Powerful handle.



ITEM NO.	TRANSP. LENGTH (CM)	LENGTH (CM)	HEAD SIZE (CM)	CELL (CM)	MATERIAL
LJ-7355-170	101	170	70 x 60	0,9 x 0,9	polyester rubberized

## LUCKY JOHN FOLDING TELESCOPIC LANDING NET **NEW**



ITEM NO.	TRANSP. LENGTH (CM)	LENGTH (CM)	HEAD SIZE (CM)	MATERIAL
LJ7060-180LN	75	180	70 x 60	polyester rubberized

## LUCKY JOHN FOLDING TELESCOPIC LANDING NET **NEW**



ITEM NO.	TRANSP. LENGTH (CM)	LENGTH (CM)	HEAD SIZE (CM)	CELL (CM)	MATERIAL
LJ-7362-195	96	195	50 x 65	0,6 x 1,5	polyester rubberized

## LANDING NET **NEW**



**BBS**  
BIG BRIT SERIES

ITEM NO.	TRANSP. LENGTH (CM)	LENGTH (CM)	HEAD SIZE (CM)	MATERIAL
LJ8570-215LN	140	215	85 x 70	polyester rubberized

## LUCKY JOHN FLOATING ANCHOR **NEW**

Floating anchor that keeps the boat in a slow drift.



ITEM NO.	SIZE (CM)
LJBSS120-120FA	120 x 120

## LUCKY JOHN FISHING PLIERS **BBS** NEW

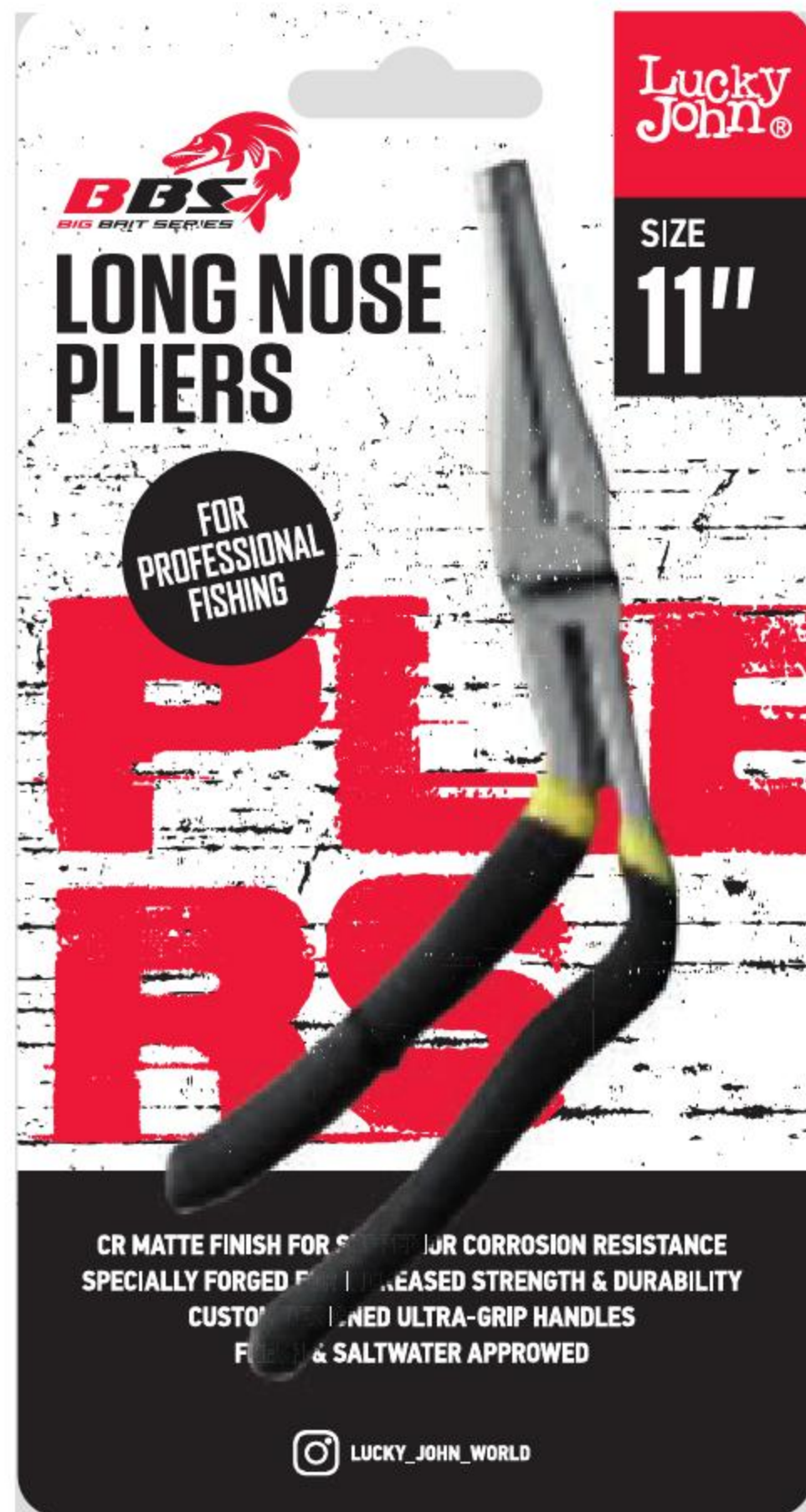

ITEM NO.	SIZE (CM)	MATERIAL
LJBBS279-FP	27,9	STEEL

## FISH MOUTH OPENER **BBS** NEW

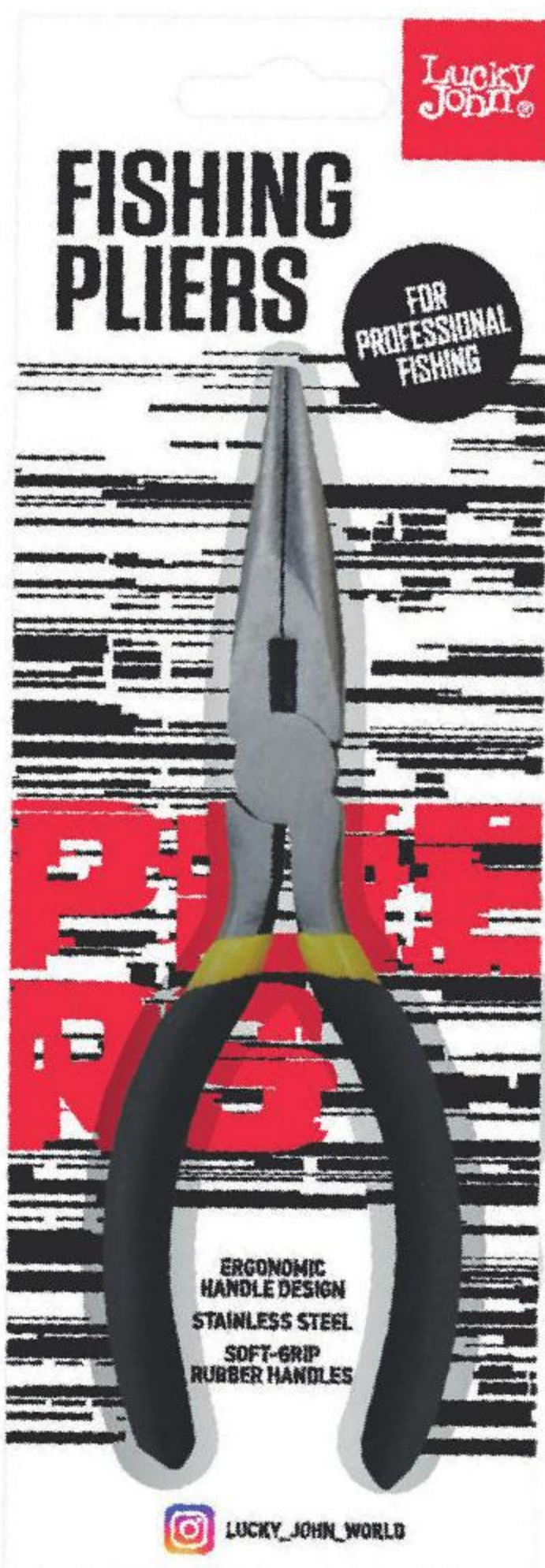

ITEM NO.	SIZE (CM)	MATERIAL
LJ230-FP	23,0	STEEL

## LUCKY JOHN FISHING PLIERS



ITEM NO.	SIZE (CM)	MATERIAL
LJ180-FP	180	STEEL

## LUCKY JOHN FISHING PLIERS



ITEM NO.	SIZE (CM)	MATERIAL
LJ165-FP	165	STEEL

## LUCKY JOHN **PREDATOR GLOVES BBS** NEW

Fish handling gloves equipped with a carabiner and detachable magnet for attaching to the belt or backpack.



ITEM NO.	SIZE (CM)
LJBBS-FGR	L

## TIP COVER & ROD BELT

Lucky John spinning rods' tip cover and rod belt. Color – black.



ITEM NO.	BRAND
LJ263	Lucky John

## ROD BELT LUCKY JOHN



ITEM NO.	SIZE (CM)
LJ264-100	100
LJ264-120	120
LJ264-130	130

## FISH GRIPPER PLASTIC

**NEW**

Plastic fish gripper. A special device for pulling pike out of the water, grabbing a large bait. It is also useful for followers of C&R (catch-release), as it minimally injures the fish.



ITEM NO.
LJ-9604

## BRAIDED LINE CUTTER WITH RING OPENER

Scissors designed for cutting braided fishing line, which is possible thanks to the serrated surface of the blades. Scissors are equipped with a ring opener.



ITEM NO.
LJ-133-03

## Lucky John

**NEW**

## ELECTRONIC SCALES BBS

Electronic scales for weighing the caught fish. Equipped with an electronic thermometer. The maximum weight of fish is 50 kg.



**BBS**  
BIG BAIT SERIES

ITEM NO.
LJBBS050-FS

## FISH MOUTH OPENER BBS



ITEM NO.	LENGTH (CM)
LJ24-04MO	24

## FISH GRIPPER METAL

Metal fish gripper. A special device for pulling pike out of the water, grabbing a large bait. It is also useful for followers of C&R (catch-release), as it minimally injures the fish.



ITEM NO.
LJ-9603

## FISH MEASURING MAT











**BBS**  
BIG BAIT SERIES

ITEM NO.	SIZE (CM)
LJ132-64FMM	132 x 64

## SOFT LURES LUCKY JOHN PRO SERIES

All Lucky John lures have stable flavour and smell (crayfish, shrimp or mackarel). The flavouring and aromatic substances are not only applied to the lures surfaces, but also are the part of lures material. Scent&Taste Inside Formula guarantees that 65% of attractant is placed inside lure material, other 35% composes special substance used for lures treating before packaging. The attractant composition is a secret of Lucky John Company. This way in these lures made of the „eatable rubber” an attractant is maximally kept for the long time. The color-grade is also well matched, the range of lures includes all colors, popular among anglers, therefore, it is easy to choose the required one. For example, the popular among perch-anglers green-brown color-grade is presented by few colors variants. Among them are Cola – well-known „engine oil” and close to this color Nagoya Shrimp „american”, Green Pumpkin, Dark Green and Kiwi Seed. There are many other variants of colorations, so Lucky John has its solution for all kinds of predator’s mood.

 <p>3D Live Series</p>	 <p>Designed in Japan</p>	 <p>Scent &amp; Taste Inside Formula</p>
 <p>Floating Soft Plastic System</p>	 <p>Real Fish Action</p>	 <p>Area Trout Game</p>
 <p>Ultra Violet Colors</p>	 <p>Glow</p>	 <p>Blister Box</p>

### PACKAGE OF KUBIRA FIRE TAIL

7"/9"

**NEW**



KUBIRA FIRE TAIL is a softbait with wide profile, long curly tail, and wobbling action. A magnet for the big pike at any time of the year. Rig it any way you prefer with Deep Pike Stinger in combination with Flexhead or use shallow screw version stinger.

ITEM NO.	COLOR	LENGTH ("/CM)	Q-TY IN PACKAGE (PCS.)
140436-***	PG18, PG27, PG30, PG36, PG37, PG38, PG40, PG41 PG42	7,0/17,50	2
1404347-***	PG18, PG27, PG30, PG36, PG37, PG38, PG40, PG41 PG42	9,0/22,8	1



## PACKAGE OF KUBIRA SWIM SHAD

5"/7"/9"/10,3"/12"



KUBIRA SWIM SHAD is a classic large twister created using 3D technology. The lure is impregnated with shrimp attractant. The bait is available in 5 sizes: 5, 7, 9, 10,3 and 12 inches. The body of the bait has special cut for offset hook easy insertion.

ITEM NO.	COLOR	LENGTH ("/CM)	Q-TY IN PACKAGE (PCS.)
140420-***	PG01, PG02, PG03, PG06, PG08, PG13, PG14, PG15, PG16, PG17, PG18, PG19, PG21, PG22, PG23, <b>PG27</b> , PG28, <b>PG29</b> , <b>PG36</b>	5,0/12,50	3
140421-***	PG01, PG02, PG03, PG06, PG08, PG13, PG14, PG15, PG16, PG17, PG18, PG19, PG21, PG22, PG23, <b>PG27</b> , PG28, <b>PG29</b> , <b>PG36</b>	7,0/15	2
140433-***	PG01, PG14, PG17, PG18, PG21, PG22, PG23, <b>PG27</b> , PG28, <b>PG29</b> , <b>PG30</b> , <b>PG36</b> , <b>PG38</b>	9,0/22,8	1
140434-***	PG14, PG18, PG21, PG22, PG23, <b>PG27</b> , PG28, <b>PG29</b> , <b>PG36</b> , <b>PG38</b>	10,3/26	1
<b>NEW</b> 140435-***	<b>PG18</b> , <b>PG30</b> , <b>PG36</b>	12,0/32	1



## PACKAGE OF KUBIRA SWIM SHAD SET

9"/10,3"



KUBIRA SWIM SHAD is a classic large twister created using 3D technology. The lure is impregnated with shrimp attractant. The set includes LJ STINGER SYSTEM SSW.



ITEM NO.	COLOR	LENGTH ("/CM)	Q-TY IN PACKAGE (PCS.)
140433SET-***	PG14, PG18, PG21, PG22, PG23, PG28	9,0/22,8	1 + LJP7401-L
140434SET-***	PG14, PG18, PG21, PG22, PG23, PG28	10,3/26	1 + LJP7401-XL

## PACKAGE OF RED TAIL SHAD

3,5"/5"



ITEM NO.	COLOR	LENGTH ("/CM)	Q-TY IN PACKAGE (PCS.)
140426-***	PG01, PG03, PG14, PG15, PG18, PG22, PG31, PG32, PG33, PG34, PG35	3,5/8,9	5
140427-***	PG01, PG03, PG14, PG15, PG18, PG22, PG31, PG32, PG33, PG34, PG35	5/12,5	3



## PACKAGE OF ZANDER PADDLE TAIL

4,8"

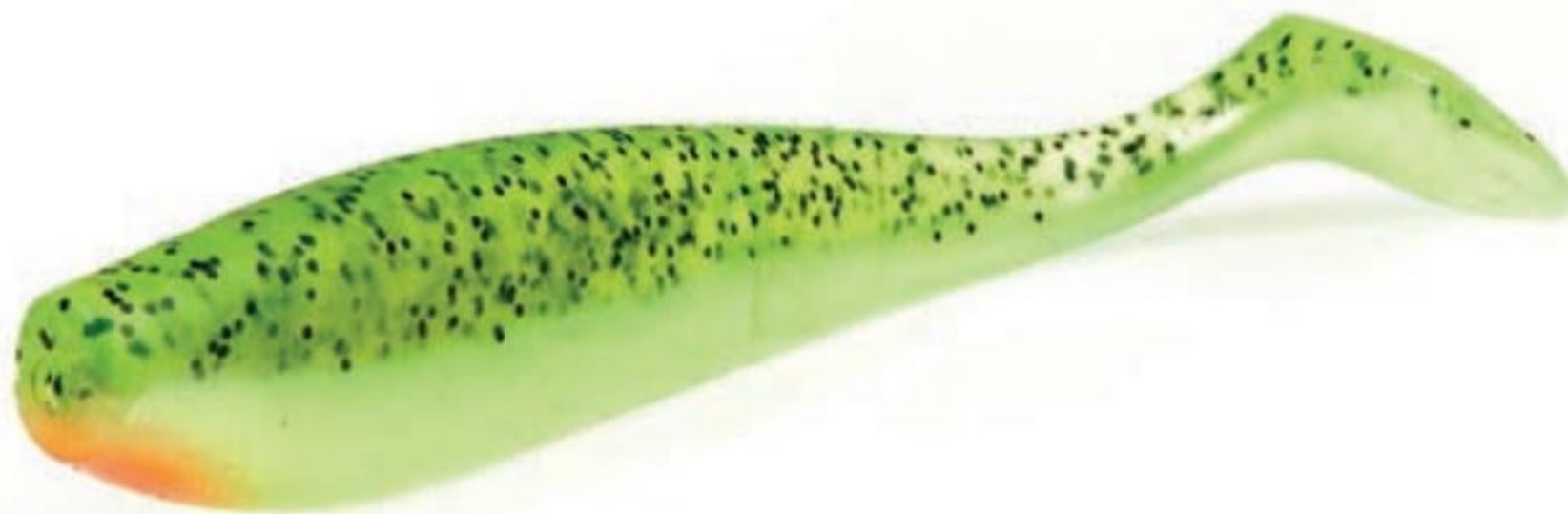

ITEM NO.	COLOR	LENGTH ("/CM)	Q-TY IN PACKAGE (PCS.)
140430-***	Z01, Z02, Z03, Z04, Z05, Z06, Z07, Z08, Z09, Z10	4,8/12	4



## PACKAGE OF ROACH PADDLE TAIL

3,5"/5"



Soft lure Lucky John Pro Series ROACH PADDLE TAIL was created using the new technology, which allows to combine contrasting colors without losing brightness. This is the first triple color injection paddle tail and completely new color combination for freshwater predators.

Available in two popular sizes: 3,5 and 5 inches, the weight of the 3,5" bait is 6,4 grams, and 5,0" – 14 grams.

ITEM NO.	COLOR	LENGTH ("/CM)	ATTRACTANT	Q-TY IN PACKAGE (PCS.)
140180-***	G01, G02, G03, G04, G05, G06, G07, G08	3,5/8,9	Squid	6
140181-***	G01, G02, G03, G04, G05, G06, G07, G08	5/12,7	Squid	4

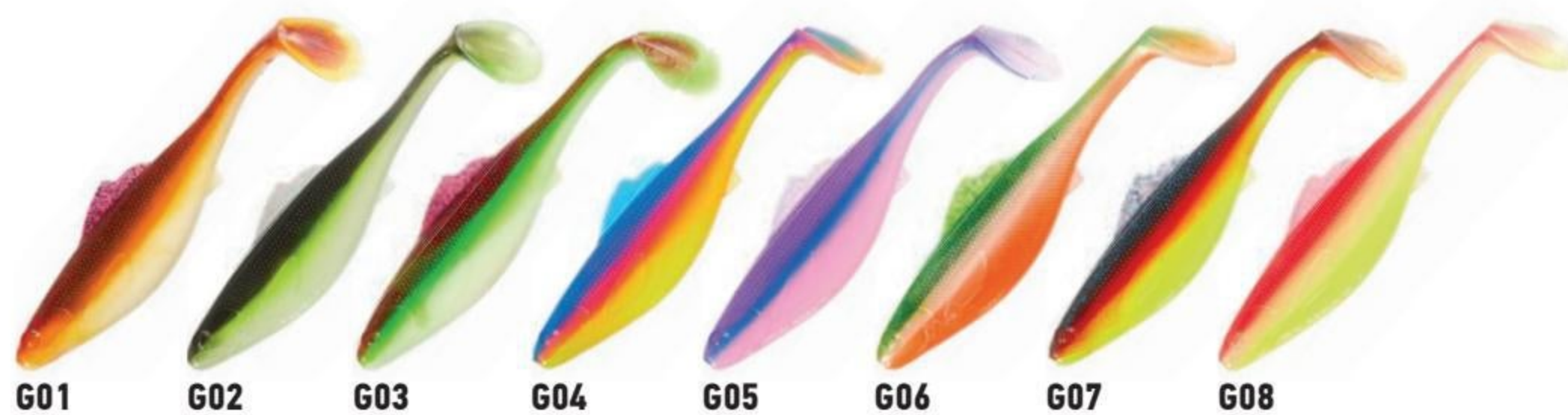



PACKAGE OF SHADS **3D SLICK SHAD-V**  
5"/7"/9"



The new 3D SLICK SHAD-V is the latest model of shads generated by Lucky John. A new split tail concept soft plastic developed for pelagic, drop shot and jigging methods.

ITEM NO.	COLOR	LENGTH ("/CM)	Q-TY IN PACKAGE (PCS.)
140423-***	001, 002, 004, 005, 008, 009, 010, 012	5"/12,7	5
140424-***	001, 002, 004, 005, 008, 009, 010, 011, 012	7"/ 17,8	3
140425-***	002, 003, 004, 006, 007, 008, 009, 010, 011, 012	9"/ 22,8	2



PACKAGE OF SHADS **3D BASARA SOFT SWIM**  
2,5"/3,5"/5,0"/6,0"



3D BASARA SOFT SWIM – a soft plastic lure that has a realistic color with a 3D effect. The bait is available in 4 sizes: 2,5" (6,3 cm), 3,5" (8,9 cm), 5" (12,7 cm) and 6" (15,2 cm). Sizes 2,5 and 3,5 inches are perfect for catching perch and pike perch, sizes 5 and 6 are the best for pike fishing. The lure is coated with shrimp attractant. There is special cut in the body of the bait for offset hook insertion.

ITEM. NO	COLOR	LENGTH ("/CM)	Q-TY PER PACK
140402-***	PG01, PG02, PG03, PG04, PG05, PG06, PG07, PG08, PG10, PG11, PG12	2,5/6,3	8
140403-***	PG01, PG02, PG03, PG04, PG05, PG06, PG07, PG08, PG10, PG11, PG12, PG13	3,5/8,9	6
140404-***	PG01, PG02, PG03, PG04, PG05, PG06, PG07, PG08, PG10, PG11, PG12, PG13	5,0/12,7	4
140405-***	PG01, PG02, PG03, PG04, PG05, PG06, PG08, PG10, PG11, PG12, PG13	6,0/15,2	3



## BOX OF SHADS 3D BASARA SOFT SWIM/BOX 2,5"/3,5"/5,0"/7,5"



3D BASARA SOFT SWIM/BOX – a soft plastic lure that has a realistic color with a 3D effect. The bait is available in 4 sizes: 2,5" (6,3 cm), 3,5" (8,9 cm), 5" (12,7 cm) and 7,5" (18,9 cm). The number of lures in a box varies by size. The lure is coated with shrimp attractant. There is special cut in the body of the bait for offset hook insertion.



ITEM. NO	COLOR	LENGTH ("/CM)	QTY IN BOX	QTY IN ONE LEVEL	LEVELS
B140402-***	PG02, PG05, PG07, PG08, PG10	2,5/6,3	70	14	5
B140403-***	PG02, PG05, PG07, PG08, PG10	3,5/8,9	50	10	5
B140404-***	PG02, PG05, PG07, PG08, PG10	5,0/12,7	40	8	5
B140414-***	PG02, PG05, PG07, PG08, PG10	7,5/18,9	16	4	4

## BOX OF SHADS 3D ANIRA SOFT SWIM 5,0"/6"/6,8"

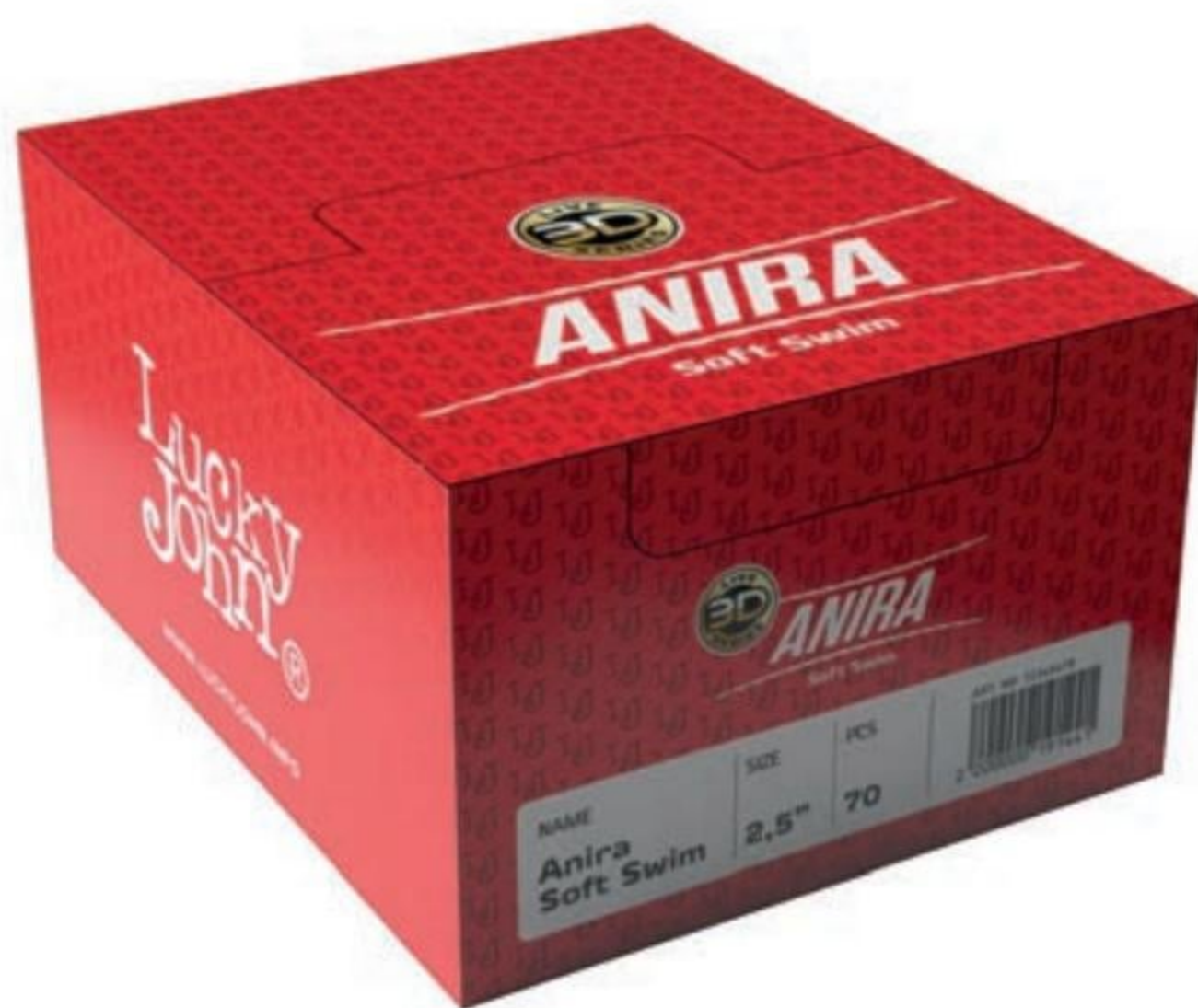

ANIRA SOFT SWIM – lure that has a realistic shape of a natural fish and color with a 3D effect. The bait is made of high-quality soft PVC plastic, which has proven its efficiency in Lucky John 3D series. Lures do not have an edible effect. The model comes in 3 sizes, multiple colorings and has Lucky John already known signature – “angry eyes”. Individual and big box packaging available. 3D ANIRA SOFT SWIM is recommended to use with Lucky John stingers LJP740\*\*\* and other terminal tackle.



ITEM. NO	COLOR	LENGTH ("/CM)	Q-TY PER PACK
B140414-***	A01, A02, A03, A04, A05	5/12,7	16
B140415-***	A01, A02, A03, A04, A05	6/15,2	16
B140416-***	A01, A02, A03, A04, A05	6,8/17,0	9

## PACKAGE OF SHADS 3D MAKORA SHAD TAIL

3,0"/4,0"/5,0"/6"



3D MAKORA SHAD TAIL – a soft plastic lure made in the classic shape of a shad tail. 3D technology gives the lure lifelike appearance. This is highly important when fishing in clear water. The bait is available in 4 sizes: 3" (7,6 cm); 4" (10 cm); 5" (12,7 cm) and 6" (15,2 cm). Sizes 3 and 4 inches are perfect for catching perch and pike perch, sizes 5 and 6 inches are the best for pike fishing. 3D Makora Shad Tail lures are available in 7 colors.



ITEM. NO	COLOR	LENGTH ("/CM)	Q-TY PER PACK
140406-***	001, 002, 003, 004, 005, 006, 007	3,0/7,6	7
140408-***	001, 002, 003, 005, 006, 007	4,0/10	6
140408-MIX1	001, 002, 003, 005, 006, 007	4,0/10	6
140410-MIX1	001, 005, 006, 007	5,0/12,7	4
140412-***	001, 002, 004, 005, 006, 007	6,0/15,2	3



## PACKAGE OF SHADS 3D MAKORA SPLIT TAIL

3,0"/4,0"



3D MAKORA SPLIT TAIL – a soft plastic lure, made in the shape of a fish. The bait is perfect for «drop-shot», as well as for jiggling techniques. 3D technology gives the lure lifelike appearance. This is highly important when fishing in clear water. The bait is available in 2 sizes 3" (7,6 cm) and 4" (10 cm) that are perfect for catching perch and pike perch. 3D Makora Split Tail lures are available in 7 colors.



ITEM. NO	COLOR	LENGTH ("/CM)	Q-TY PER PACK
140407-***	002, 003, 004, 005, 006, 007	3,0/7,6	7
140409-***	001, 003, 004, 005, 006, 007	4,0/10,1	6



**NEW**

## FREDDY FROG 2,5"



FREDDY FROG is a true frog imitation with two legs and weed protected hooks. Lure is developed for a great surface action, highly efficient for pike fishing!

ITEM NO.	COLOR	LENGTH ("/CM)	SIZE (G)	Q-TY IN PACKAGE (PCS.)
140422-***	007, 008, 009, 010, 011, 012	2,5"/6,3	23	1



## FROG 2,0"/2,6"



FROG – a soft rubber, surface floating lure. The lure imitates a frog and is designed for catching predators in heavily overgrown waters, where the use of other lures is impossible. When the bait falls in the water, the hooks are always oriented upwards, and the double-hook tips are pressed against lure's body, therefore, when guiding, the hooks do not catch on the water plants. The main fishing target is pike. The main method of guiding – light jerking of the lure with short intervals, simulating the frogs' jumps on the water surface. To avoid unrealized bites, do not rush. When you see that pike has grabbed the lure, ease the line, wait for fishing line to tighten, and only then pull. Usually, when missed, the pike repeatedly attacks the bait. The lure is made in sizes of 2" (5,0 cm) and 2,6" (6,5 cm). To avoid lost bites, it is recommended to insert an additional hook to the lure - the LJ Frog Trailer Hook (art. LJPTH-001).

ITEM NO.	COLOR	LENGTH ("/CM)	Q-TY IN PACKAGE (PCS.)
140400-**	001, 002, 003, 004, 005,	2,0/5,0	1
140401-**	001, 002, 003, 004, 005, 006	2,6/6,5	1



## TRAILER HOOK FOR LUCKY JOHN FROG

The trailer hook is designed to put on the double hooks of Lucky John FROG. An additional trailer hook significantly increases the bites of predator fish. Size L suitable for 2" (5 cm) and 2,6" (6,5 cm) FORGS.



ITEM NO.	SIZE	Q-TY IN PACKAGE (PCS.)
LJPTH-001	L	2

## PACKAGE OF UNAGI SLUG

3,0"/3,5"



The secret of the efficiency of UNAGI SLUG lies in the lure's design. The Slug is divided by thin partitions into several sections. Even with very careful jerks the tail of the lure starts actively moving and attracts the most passive fish. UNAGI SLUG is impregnated with shrimp attractant that guarantees results in any predator fishing. The lure available in 2 sizes – 3" (7,6 cm), 3,5" (8,9 cm).

ITEM NO.	COLOR	LENGTH ("/CM)	ATTRACTANT	Q-TY IN PACKAGE (PCS.)
140305-***	F01, F02, F03, F04, F05, F07, F08, F13, F29, F33	3,0/7,6	Mackerel	7
140306-***	F01, F02, F04, F05, F07, F08, F13, F33	3,5/8,9	Mackerel	5



## PACKAGE OF JOCO SHAKER SUPER FLOATING

3,5"/4,5"/5,5"



JOCO SHAKER Super Floating is a lure with a classic shape of a shad and ribbed surface of the body. The material of the lure has extremely low density, therefore it is lighter than water. The lure will retain its floating properties even after its use on different tackles and after pike's "bites". The lure is impregnated with mackerel attractant, which is also applied to lure's surface in liquid form. The bait has a special "pocket" for offset hook insertion. JOCO SHAKER SUPER FLOATING is produced in the following sizes: 3,5" (8,9 cm) – for catching perch and zander, 4,5" (11,4 cm) and 5,5" (13,8 cm) – for catching pike.

ITEM NO.	COLOR	LENGTH ("/CM)	ATTRACTANT	Q-TY IN PACKAGE (PCS.)
140302-***	F01, F03, F04, F13, F29, F33, T42	3,5/8,9	Mackerel	4
140303-***	F03, F05, F13, F29, F33, T42	4,5/11,4	Mackerel	3
140307-***	F03, F05, F13, F15, F29, T42, T50, MIX1, MIX2	5,5/13,97	Mackerel	3



## PACKAGE OF SHADS **TIOGA**

2"/2,4"/2,9"/3,4"/3,9"



TIOGA is a lure specially designed for perch and pike perch (zander) fishing. The unique shape of the body provides movements in the water generating swings attracting a predator. The side ribs serve to enhance the lure's play, making its movements more real. This hybrid lure has a worm-like body with the typical thickening in the front part and small claw-tail of the shad. The lure is impregnated with a mackerel attractant. TIOGA is available in multiple colors and 5 sizes – 2" (5,1 cm), 2,4" (6,1 cm), 2,9" (7,4 cm), 3,4" (8,6 cm), 3,9" (9,9 cm).

ITEM NO.	COLOR	LENGTH ("/CM)	ATTRACTANT	Q-TY IN PACKAGE (PCS.)
140102-***	033, 071, 085, F05, PA01, PA03, PA19, S10, S13, S14, S26, S88	2/5,1	Mackerel	10
140119-***	033, 071, 085, F05, F08, PA01, PA03, PA19, S08, S10, S13, S14, S63, S67, S88, T05, T18, T36, T44, T46, T50, T51, T52, T53, T54, T56, T57, T61, T64, T65, T66, T68, T69	2,4/6,1	Mackerel	9
140103-***	033, 071, 085, F05, PA01, PA03, PA19, S08, S13, S14, S63, S67, T18, T18, T26, T44, T46, T47, T50, T51, T52, T56, T57, T61, T64, T65, T66, T68, T69	2,9/7,4	Mackerel	7
140127-***	033, 071, 085, F05, PA03, PA19, S08, S13, S63, S67, T44, T46, T47, T51, T61, T64, T65, T66, T68, T69	3,4/8,6	Mackerel	6
140104-***	S08, S63, S67, T51, T61, T64, T65, T66, T68, T69	3,9/9,9	Mackerel	5

COLOR	2	2,4"	2,9	3,4	3,9
033	2	2,4	2,9	3,4	
071	2	2,4	2,9	3,4	
085	2	2,4	2,9	3,4	
F05	2	2,4	2,9	3,4	
F08		2,4			
PA01	2	2,4	2,9		
PA03	2	2,4	2,9	3,4	
PA19	2	2,4	2,9	3,4	
S08		2,4	2,9	3,4	3,9
S10	2	2,4			
S13	2	2,4	2,9	3,4	
S14	2	2,4	2,9		
S26	2				

COLOR	2	2,4"	2,9	3,4	3,9
S63		2,4	2,9	3,4	3,9
S67		2,4	2,9	3,4	3,9
S88	2	2,4			
T05		2,4			
T18		2,4	2,9		
T26			2,9		
T36		2,4			
T44		2,4	2,9	3,4	
T46		2,4	2,9	3,4	
T47			2,9	3,4	
T50		2,4	2,9		
T51		2,4	2,9	3,4	3,9
T52		2,4	2,9		

COLOR	2	2,4"	2,9	3,4	3,9
T53		2,4			
T54		2,4			
T56		2,4	2,9		
T57		2,4	2,9		
T61		2,4	2,9	3,4	3,9
T64		2,4	2,9	3,4	3,9
T65		2,4	2,9	3,4	3,9
T66		2,4	2,9	3,4	3,9
T68		2,4	2,9	3,4	3,9
T69		2,4	2,9	3,4	3,9

# PACKAGE OF SHADS TIOGA FAT

3,9"/4,5"/5,8"



TIOGA FAT – a lure designed for angling trophy predators. The unique shape of the body provides movements in the water generating swings attracting a predator. The side ribs serve to enhance the lure's paly, making its movements more real. This hybrid lure has a worm-like body with the typical thickening in the front part and small claw-tail of the shad. The lure is impregnated with a mackerel attractant. The body of the lure has special "pocket" for offset hook insertion. TIOGA FAT is available in multiple colors and 3 sizes – 3,9" (9,9 cm), 4,5" (11,4 cm), 5,8" (14,7 cm).

ITEM NO.	COLOR	LENGTH ("/CM)	ATTRACTANT	Q-TY IN PACKAGE (PCS.)
140146-***	033, 071, F05, F08, PA03, PA16, S13, S26, T05, T18, T26, T44	3,9/9,9	Mackerel	5
140147-***	071, F05, F08, PA03, PA16, S13, S26, T05, T18, T26, T44	4,5/11,4	Mackerel	4
140148-***	033, 071, F08, PA03, PA16, S13, S26, T18, T26, T44	5,8/14,7	Mackerel	3



## PACKAGE OF S-SHAD TAIL

2,8"/3,8"



S-SHAD TAIL is a shad with an elongated ribbed body. Lure's body has a different cross section in the front and back parts - this geometry of the lure gives it a special game that attracts any predator. S-SHAD TAIL is manufactured using advanced technology. The lure has explicit taste and scent of mackerel - its body is impregnated with an attractant and coated with a special aromatic oil. After fishing it is recommended to put the lure back into the package, since it contains aromatic oil, and lure will "recharge". S-SHAD TAIL is a great solution for fishing from early spring to late fall. S-SHAD TAIL available in various colors and 2 sizes - 2,8" (7,1 cm) and 3,8" (9,6 cm).

ITEM NO.	COLOR	LENGTH ("/CM)	ATTRACTANT	Q-TY IN PACKAGE (PCS.)
140144-***	071, PA01, PA29, S13	2,8/7,1	Mackerel	7
140145-***	033, 071, F05, PA29, S13, S26, T05, T18, T48	3,8/9,6	Mackerel	5



## PACKAGE OF SHADS MINNOW

2,2"/3,3"/4,4"/5,5"



LJ MINNOW is the most popular model of shads with a classic shape. The lure's little fish like body along with the tail fin generate incredible game when moving in water. The base of the lure is soft plastic which perfectly retains the shape of the lure and is resistant to external impacts. The lure has explicit taste and scent of mackerel - its body is impregnated with an attractant and coated with a special aromatic oil. This strong attractant and a wide range of colors makes this lure universal for any type of fishing for the most popular predators. MINNOW available in 4 sizes - 2,2" (5,6 cm), 3,3" (8,4 cm), 4,4" (11,1 cm), 5,5" (13,9 cm).



ITEM NO.	COLOR	LENGTH ("/CM)	ATTRACTANT	Q-TY IN PACKAGE (PCS.)
140142-***	071, 085, F05, S13, T05, T18, T26, T44, T46, T47, T50, T51, T52	2,2/5,6	Mackerel	10
140143-***	033, 071, 085, F05, S13, T05, T18, T26, T44, T46, T48, T56, T57	3,3/8,4	Mackerel	7
140150-***	033, 05, T05, T18, T26, T44	4,4/11,1	Mackerel	5
140151-***	033, F05, S13, T05, T18, T26, T44	5,5/13,9	Mackerel	4





## PACKAGE OF SHADS **LONG JOHN**

3,1"/4,2"



LONG JOHN – one of the most popular soft lure models in the world. The stretched body gives it the unique game - effect of “wriggling” lure. LONG JOHN perfectly works with classic jigging method and with any other technique. The lure has explicit taste and scent of mackerel – its body is impregnated with an attractant. Perfect proportions of the body and the tail always ensure steady operation of the lure with various weights. LONG JOHN available in many different colors and 2 sizes – 3,1” (7,9 cm), 4,2” (10,7 cm).

ITEM NO.	COLOR	LENGTH ("/CM)	ATTRACTANT	Q-TY IN PACKAGE (PCS.)
140118-***	071, F05, PA03, S14, T18	3,1/7,9	Mackerel	8
140134-***	071, T05, T18, T26, T44	4,2/10,7	Mackerel	6



## PACKAGE OF **HAMA STICK** 3,5"



LJ HAMA STICK has long stretched body without any active elements which makes it a passive lure. HAMA STICK is very popular for drop shot fishing and for fishing in heavily overgrown waters. The lure has special “pocket” for offset hook insertion. It is impregnated with a mackerel attractant, its size – 3,5” (8,9 cm) and colorings are perfect for zander, perch and pike fishing.

ITEM NO.	COLOR	LENGTH ("/CM)	ATTRACTANT	Q-TY IN PACKAGE (PCS.)
140138-***	033, 071, T05, T09, T26, T46	3,5/8,9	Mackerel	9



## PACKAGE OF SHADS **BABY ROCKFISH**

1,4"/2,4"



LJ BABY ROCKFISH – one of the most popular ice fishing soft plastic lures, however it can be perfectly used for micro jigging in open waters. The lure has strong, lasting mackerel scent and taste. It is available in 2 sizes – 1,4" (3,5 cm); 2,4" (6,1 cm).



ITEM NO.	COLOR	LENGTH ("/CM)	ATTRACTANT	Q-TY IN PACKAGE (PCS.)
140149-**	071, 085, S13, S14, S21, F05	1,4/3,5	Mackerel	20
140162-**	071, 085, S13, F05	2,4/6,10	Mackerel	10

## PACKAGE OF TWISTERS **BALLIST**

2,5"/3,3"



LJ BALLIST is a hybrid of a worm and a twister with lasting shrimp attractant. The lure has a stretched, ribbed worm-like body and a small soft twister tail. It can imitate a leech or a big nymph. It perfectly works for different kind of micro jigging. BALLIST is available in multiple colorings and 2 sizes – 2,5" (6,3 cm), 3,3" (8,4 cm).



ITEM NO.	COLOR	LENGTH ("/CM)	ATTRACTANT	Q-TY IN PACKAGE (PCS.)
140101-***	071, F05, PA01, PA03, PA16, PA19, S13, S14, S18, S19, S26, S63, T51, T61, T64, T65, T66, T68, T69	2,5/6,3	Shrimp	10
140128-***	071, F05, F08, PA16, S13, S14, S26, S63, S67, T51, T61, T64, T65, T66, T68, T69	3,3/8,4	Shrimp	8



## PACKAGE OF MICRO GRUB 1,0"



LJ MICRO GRUB – classic micro twister designed for ice fishing. However, it can be very efficiently used for micro jigging. The lure works perfectly either for fishing small predators or peaceful carppies. MICRO GRUB is available in various colorings and size – 1,0" (2,5 cm).

ITEM NO.	COLOR	LENGTH ("/CM)	ATTRACTANT	Q-TY IN PACKAGE (PCS.)
140159-***	026, 036, 071, 085, PA01, PA03, PA19, S13, S88	1,0/2,5	Mackerel	15



026 036 071 085 PA01 PA03 PA19 S13 S88

## PACKAGE OF J.I.B. TAIL

1,5"/2,0"



J.I.B. Tail is the series of scented twisters specially designed for perch fishing. Due to the material softness and elasticity the lure is well held by a hook. J.I.B. Tail is available in two sizes. The size 1,5" is well matched for fishing with micro jig. They can be used in all kinds of the installations: Jig Head Rig, Texas Rig, Carolina Rig, Terminal Rig, Drop Shot Rig and Double Hook Rig. The size 2" – perfectly matches to a wire lead and a classic jig. J.I.B. Tail is impregnated with a shrimp attractant.

ITEM NO.	COLOR	LENGTH ("/CM)	ATTRACTANT	Q-TY IN PACKAGE (PCS.)
140121-***	PA03, PA39, S13, <b>S15, S21</b> , T28,	1,5/3,8	Mackerel	15
140122-***	PA03, PA39, S13, S15, S21, T28	2,0/5,0	Mackerel	10



PA03 PA39 S13 S15 S21 T28

## PACKAGE OF SLUG TRICK WORM 2,0"/2,5"



AREA  
*Trout*  
GAME



LJ TRICK WORK – multi species bait, made from a PVC plastic, enriched with amino acids, and impregnated with a garlic attractor. This bait moves like its real; with a fully ribbed body and strong scent it allows fish to find it for a bite they won't let go. Specially designed for trout fishing but rigged on a jig head this will catch anything, trout, crappies, walleye/zander, perch and bass. Drop shot it in clear water for those finicky goliath smallmouth bass. Bright solid and double-colored lures are available in two sizes – 2,0" (5,0 cm), 2,5" (6,35 cm).

**Best New Product Award Winner at EFTTEX 2018–19.**

ITEM NO.	COLOR	LENGTH ("/CM)	ATTRACTANT	Q-TY IN PACKAGE (PCS.)
140160-**	026, 036, 101, F05, S88, T90, T91, T92, T93, T94, T95, T96, T97	2,0/5,0	Garlic	10
140177-**	T90, T91, T92, T93, T94, T95, T96, T97	2,5/6,35	Garlic	7



## PACKAGE OF SLUG TIPSY WORM 2,3"/2,8"



LJ TIPSY WORM – multi species bait, made from a PVC plastic, enriched with amino acids, and impregnated with a cheese attractor. Specially designed for trout fishing, however bait can be successfully used for freshwater perch or saltwater rockfish fishing. The lure attracts not only predators but also peaceful white fish. TIPSY WORM available in multiple bright colors and two sizes – 2,3" (5,8 cm), 2,8" (7 cm).

ITEM NO.	COLOR	LENGTH ("/CM)	ATTRACTANT	Q-TY IN PACKAGE (PCS.)
140175-**	T70, T71, T72, T73, T74, T75, T76, T77, T78, T79	2,3/5,8	Cheese	12
140176-**	T70, T71, T72, T73, T74, T75, T76, T77, T78, T79	2,8/7	Cheese	8

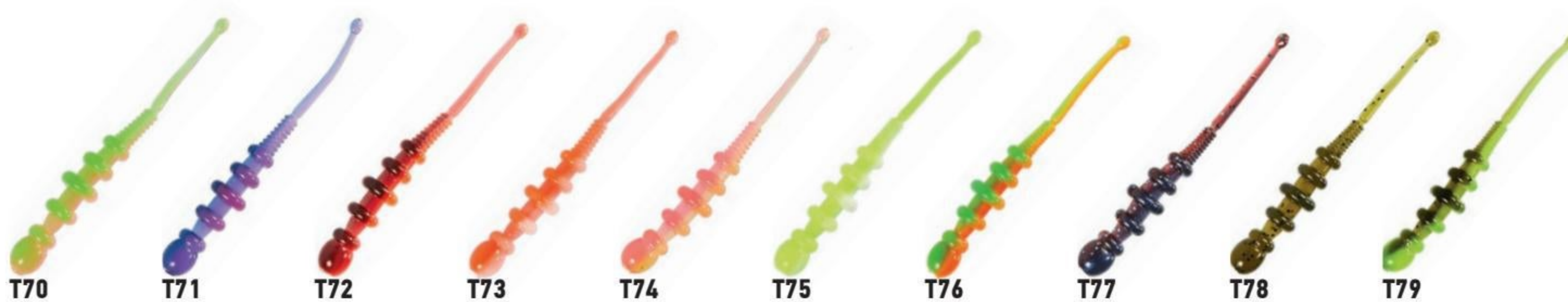

## PACKAGE OF INSECTOR 2,8"



LJ INSECTOR – creative fantasy bait made of soft plastic, with claws and paws, designed for catching freshwater predators – perch and zander. The lure is impregnated with mackerel attractant. INSECTOR is the most effective when fish are not active. Available in multiple colors and size – 2,8" (7 cm).

ITEM NO.	COLOR	LENGTH ("/CM)	ATTRACTANT	Q-TY IN PACKAGE (PCS.)
140184-	085, F05, PA03, S14, S18, S67, T36, T46, T56, T65	2,8/7	SQUID	8



085 F05 PA03 S14 S18 S67 T36 T46 T56 T65

## PACKAGE OF HOGY SHRIMP

2,2"/3"/3,5"



LJ HOGY SHRIMP – a bait imitating a fantasy underwater crayfish with many legs hunted by big perches and other predators. HOGY SHRIMP is a passive lure, it is impregnated with a crayfish attractant, very efficient for freshwater and saltwater fishing, recommended for catching perch and zander. HOGY SHRIMP available in various natural colors and 3 sizes – 2,2" (5,6 cm), 3" (7,6 cm), 3,5" (8,9 cm).



ITEM NO.	COLOR	LENGTH ("/CM)	ATTRACTANT	Q-TY IN PACKAGE (PCS.)
140163-***	033, 085, PA01, PA03, S14, S18, S19, S21, SB05	2,2/5,6	Crayfish	10
140140-***	033, 085, PA01, PA03, S14, S18, S19, S21, SB05	3/7,6	Crayfish	10
140174-***	033, 085, PA01, PA03, S14, S15, S18, S19, S21, SB05	3,5/8,9	Crayfish	5



S21 S15 SB05 PA03 S14 033 S19 S18 PA01 085

## PACKAGE OF ROCK CRAW 2,0"



LJ ROCK CRAW – a bait imitating a crayfish. This lure is active, unlike other passive baits of this type. The lure is universal – it may be used on a classic jig or on different leader systems. The lure’s moving legs and tails create vibrations that attract predator fish. It is impregnated with crayfish attractant that will especially appeal to fish which have a strong sense of smell – for example, catfish. This lure will definitely attract large perch and zander, which are big crayfish lovers. The same size – 2” (5 cm) – ROCK CRAW is available with two different attractants – crayfish and shrimp.

ITEM NO.	COLOR	LENGTH ("/CM)	ATTRACTANT	Q-TY IN PACKAGE (PCS.)
140123-***	CA35, PA03, S02, S14, SB05	2,0/5	Crayfish	10
140123-***	036, 037, 085	2,0/5	Shrimp	10



CA35



S02



S14



036



037



085



PA03



SB05

## PACKAGE OF TWISTERS LJ NAYADA 2"



LJ NAYADA – a soft bait that accurately imitates dragonfly nymph. It is no secret that various imitations of underwater insects and crustaceans are the best lures at any time of the year and for a wide variety of fish, including peaceful ones. NAYADA is impregnated with a shrimp attractant and will efficiently work for catching perch, pike, and zander. The bait is available in various popular color and size 2” (5 cm).

ITEM NO.	COLOR	LENGTH ("/CM)	ATTRACTANT	Q-TY IN PACKAGE (PCS.)
140154-***	036; 071; F05; F08; PA03; PA16; S13; S21	2/5	Shrimp	9



036



071



F05



F08



PA03



PA16



S13



S21

PACKAGE OF **BUG**  
2,5"/3,5"



LJ BUG – soft, universal bait imitating crayfish. The lure is very active in the water, thus attracting predators. The lure is made of salty plastic and impregnated with a shrimp attractant. It is recommended to use Texas, Wacky or drop shot method, also works with a standard jig. The BUG will efficiently work for catching perch, pike, and zander. The bait is available in 2 sizes – 2,5" (6,3 Cm) and 3,5" (8,9 cm).

ITEM NO.	COLOR	LENGTH ("/CM)	ATTRACTANT	Q-TY IN PACKAGE (PCS.)
140169-***	071, 085, PA19, T52	2,5/6,3	Shrimp	8
140170-***	071, 085, PA19, S68, T52	3,5/8,9	Shrimp	6

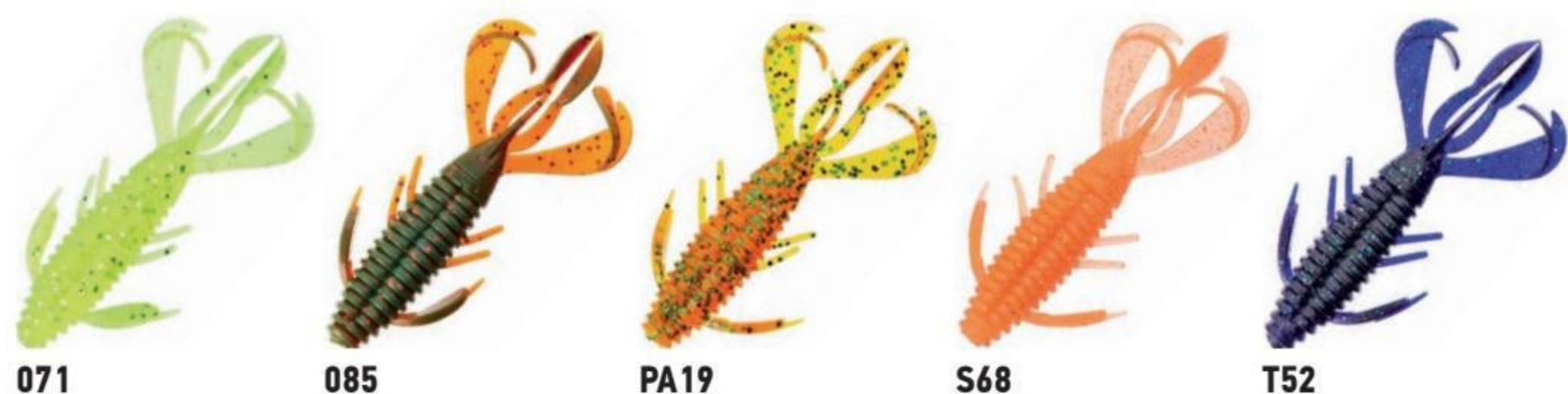

PACKAGE OF **ALIEN BUG** 1,5"



AREA  
*Trout*  
GAME



LJ ALIEN BUG – this creative lure is a fantasy insect. The bait is designed, first and foremost, to fish in difficult conditions when the predator must be "surprised". The lure is impregnated with a mackerel attractant. Size 1,5" (3,8 cm) is perfect for catching perch and other small predators. It is recommended to use Texas, Wacky or drop shot method, also works with a standard jig.

ITEM NO.	COLOR	LENGTH ("/CM)	ATTRACTANT	Q-TY IN PACKAGE (PCS.)
140164-***	033, 036, 071, 085, PA03, S13, T44, T48, T52	1,5/3,8	Mackerel	10



## Surface

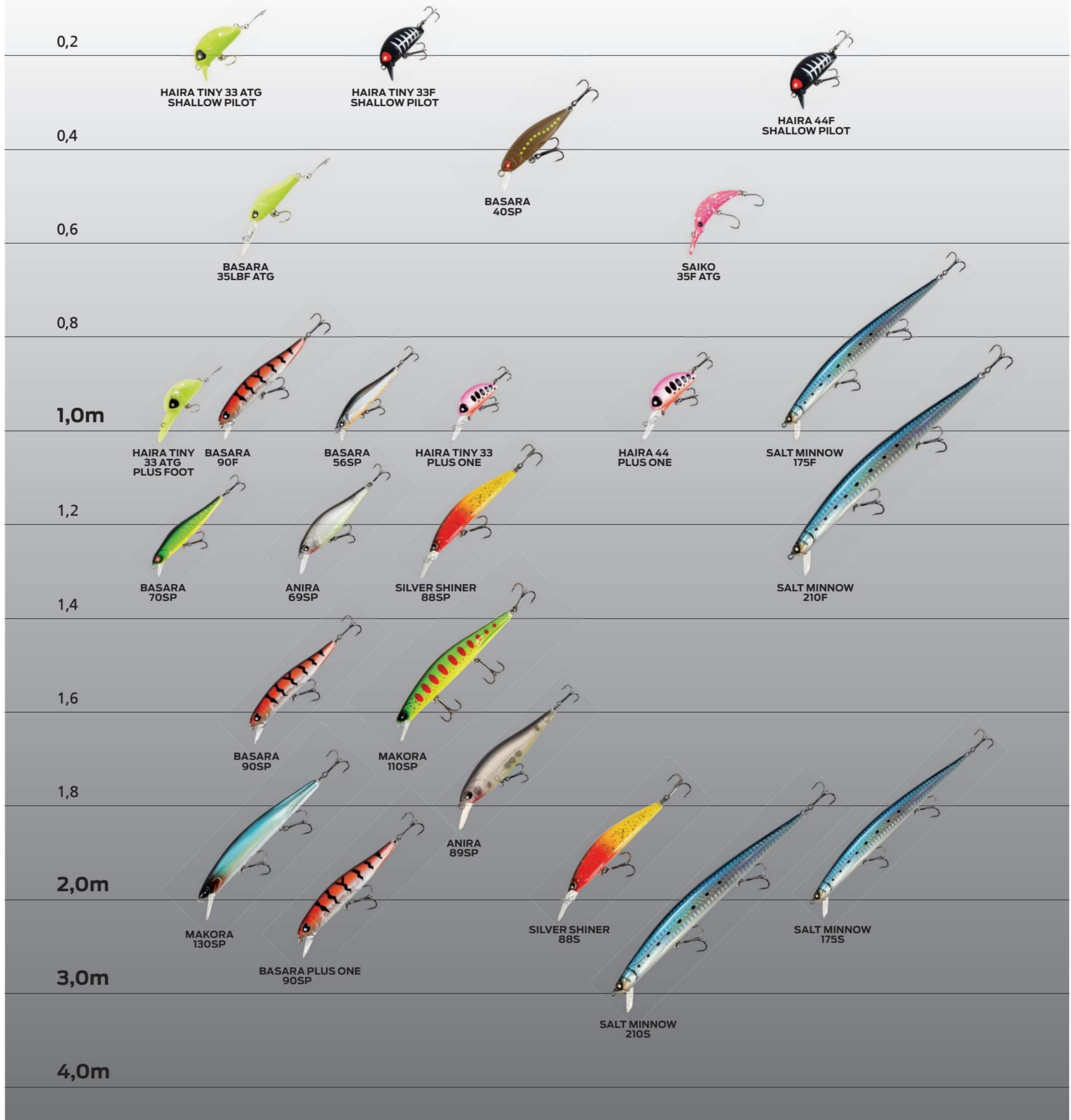

## LUCKY JOHN PRO SERIES WOBBLERS



Magnetic Cast System (MCS) – a system consisting of a magnet and fixed and static balls, which allows casting a lure for the longest distance possible without kinking and dead on target. This system ensures qualitative balancing and easy handling of a wobbler at any type of reeling. MCS system is the first patent in the production of PRO Series wobblers.

How does MCS system work? During the casting, the ball is detached from the magnet by the centrifugal force and rolls to the tail end of the lure, thus shifting the centre of gravity. After touching the water, when the reeling starts, the ball rolls to the head end of the wobbler, where it is fixed by the magnet. To ensure roll stability, there are five balls located in special compartments of the lure: three in the head end, and two – in the tail end. During the reeling, these balls have low degree of motion, thus allowing aggressive reeling with the lure.

Outside Stabilizer System (OSS) – a system of external stabilization of a lure with the help of a tungsten ball. The lower part of lure's head features a special capsule with a tungsten ball next to the dropping blade. As continuous tests of such design have shown, the weighted upper part of crank-baits is what creates distinctive vibration. OSS is not only additional vibration of the lure during the reeling, but also additional increase of flying range. At the moment, OSS system is the most effective stabilizing system of crank-bait class lures.

### Complete set

Wobblers are equipped with high-quality Japanese hooks and factory guides.



LJ MAKORA wobbler is the classic series of jerk-baits designed in two sizes – 110 mm and 130 mm. The wobblers of these series are special by their unique action they demonstrate during jerking and even guiding. Its body combined with the weight makes the wobbler move from side to side and turning a little around when jerking. The Magnetic Cast System of the wobbler will ensure long casting distance with very high precision. MAKORA available in two versions – floating and suspending which allows to target wide range of predators. Three treble hooks will not let fish to escape.

## MAKORA 110SP



ITEM NO.	MODEL	COLOR	TYPE	LENGTH (CM)	WEIGHT (G)	REC. BRAIDED LINE Ø (MM)	DEPTH (M)
MA110SP-***	Makora 110SP	101; 103; 121; 123; 124; 139, 146, 147, 201; 301	suspending	11,0	13	0,15	0,5–1,5

## MAKORA 130SP



ITEM NO.	MODEL	COLOR	TYPE	LENGTH (CM)	WEIGHT (G)	REC. BRAIDED LINE Ø (MM)	DEPTH (M)
MA130SP-***	Makora 130SP	101; 103; 104; 121; 124; 139, 146, 147, 201; 301	suspending	13,0	21	0,17	0,8–2



LJ ANIRA – wobbler for predator fishing in shallow still waters or slow currents. ANIRA wobblers have stable intense game, which they demonstrate both during delicate guiding and twitching. Wobblers available in 69 and 89 mm sizes, suspending version. The Magnetic Cast System ensures excellent casting distance and allows to create quite aggressive action of the lure. The main target – perch and pike.

## ANIRA 89SP



ITEM NO.	MODEL	COLOR	TYPE	LENGTH (CM)	WEIGHT (G)	REC. BRAIDED LINE Ø (MM)	DEPTH (M)
AN89SP-***	Anira 89SP	101, 103, 105, 106, 113, 305, 403, 903, 905, 911	suspending	8,9	13	0,13–0,15	0,5–1,8

## ANIRA 69SP



ITEM NO.	MODEL	COLOR	TYPE	LENGTH (CM)	WEIGHT (G)	REC. BRAIDED LINE Ø (MM)	DEPTH (M)
AN69SP-***	Anira 69SP	101, 103, 105, 106, 305, 703, 704, 903, 905, 908, 911, 912	suspending	6,9	8	0,13	1,2



LJ BASARA – the classic jerk-bait wobblers designed in sizes – 40, 56, 70 and 90 mm. All BASARA wobblers have The Magnetic Cast System that ensures excellent casting distance and allows to create quite aggressive action of the lure.

## BASARA 90F, 90SP



ITEM NO.	MODEL	COLOR	TYPE	LENGTH (CM)	WEIGHT (G)	REC. BRAIDED LINE Ø (MM)	DEPTH (M)
BA90F-***	Basara 90F	101, 103, 105, 201, 301	floating	9,0	10	0,15	1
BA90SP-***	Basara 90SP	101, 103, 104, 105, 107, 110, 139, 146, 147, 201, 215, 301, 701, 703, 704, 903, 905, 908, 911	suspending	9,0	10,5	0,15	1,5

## BASARA 70SP



ITEM NO.	MODEL	COLOR	TYPE	LENGTH (CM)	WEIGHT (G)	REC. BRAIDED LINE Ø (MM)	DEPTH (M)
BA70SP-***	Basara 70SP	101, 103, 104, 105, 107, 110, 139, 146, 147, 201, 215, 301, 703, 704	suspending	7,0	5,5	0,11	1,2

## BASARA 56SP



ITEM NO.	MODEL	COLOR	TYPE	LENGTH (CM)	WEIGHT (G)	REC. BRAIDED LINE Ø (MM)	DEPTH (M)
BA56SP-***	Basara 56SP	101, 103, 104, 105, 107, 110, 201, 301, 703, 704	suspending	5,6	3,5	0,09	1

## BASARA 40SP



ITEM NO.	MODEL	COLOR	TYPE	LENGTH (CM)	WEIGHT (G)	REC. BRAIDED LINE Ø (MM)	DEPTH (M)
BA40SP-***	Basara 40SP	101, 103, 104, 105, 107, 110, 201, 301, 704	suspending	4,0	2,5	0,064	0,5



## SILVER SHINER 88S, 88SP



LJ SILVER SHINER – minnow class wobbler designed for salmon fishing in strong and medium currents. Two wobbler types available – sinking and suspending, which allows to choose the lure for specific fishing conditions. The model shows stable action and nice balance in the stream. The Magnetic Cast System ensures excellent casting distance. The main targets of SILVER SHINER are salmon, pike, zander and perch.

ITEM NO.	MODEL	COLOR	TYPE	LENGTH (CM)	WEIGHT (G)	DEPTH (M)
SS88S-	SILVER SHINER	903, 908, 912, 913, 914, 915, 916, 917, 918, 919, 920, 921	Sinking/14g	8,8	14	0,5–2,5
SS88SP-	SILVER SHINER	903, 908, 912, 913, 914, 915, 916, 917, 918, 919, 920, 921	Suspending/12g	8,8	12	0,3–1,8



## BASARA PLUS ONE 90SP



LJ BASARA PLUS ONE – a deep water version of BASARA wobbler, with the same unique characteristics that made it irreplaceable when targeting predators. The Magnetic Cast System ensures excellent casting distance, high- quality balancing and easy control of the wobbler. A special capsule with a tungsten ball is placed in the lower part of the bait's head. The weighted front allows quickly deepen the wobbler into a working depth of 2,4 meters. BASARA PLUS ONE perfectly works for catching zander at high speed guiding or strong currents, and for pike deep water twitching. The lure available in size 90 mm.

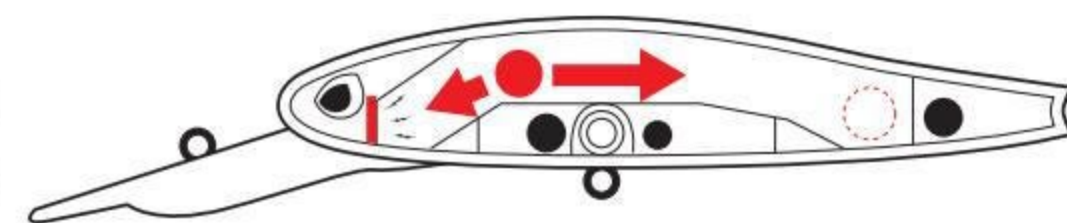

ITEM NO.	MODEL	COLOR	TYPE	LENGTH (CM)	WEIGHT (G)	REC. BRAIDED LINE Ø (MM)	DEPTH (M)
BA90SPPO-***	Basara Plus One 90SP	101, 103, 105, 201, 301	suspending	3,5/9	11	0,15	0,8–2,8



## HAIRA TINY SHALLOW PILOT 33F HAIRA TINY SHALLOW PILOT 44F



LJ TINY HAIRA SHALLOW PILOT – small Crankbait class lure with a thick body, small lip, and the size of 33 and 44 mm. The wobbler available only in floating version. The maximum working depth of the lure is 20 cm. The wobbler quickly surfaces after stopping, which allows effectively avoid underwater obstacles. The lure moves actively: it frequently vibrates, producing at the same time a noticeable and attractive wave for every predatory fish. Thanks to Outside Stabilizer System (OSS) all HAIRA TINY SHALLOW PILOT wobblers show additional vibration during reeling and they have increased casting distance. The main targets of HAIRA TINY SHALLOW PILOT are chub, trout, asp, perch, and pike.



ITEM NO.	MODEL	COLOR	TYPE	LENGTH (CM)	WEIGHT (G)	REC. BRAIDED LINE Ø (MM)	DEPTH (M)
HAT33F-***	Haira Tiny 33F	<b>147</b> , 148, 201, 202, 204, 205, 215, 301, 401, 402, 403, 404, 405, 406, <b>503</b> , 504, 506	floating	3,3	4	0,09	0,2
HAT44F-***	Haira 44F	201, 202, 204, 205, 401, 402, 403, 404, 405, 406	floating	4,4	7	0,13	0,3

## HAIRA TINY PLUS ONE 33LBF HAIRA PLUS ONE 44LBF



LJ HAIRA TINY PLUS ONE – modification of the floating version of Haira Tiny wobbler – created with a long lip (LBF). This small Crankbait class lure is able of diving to 1 meter, which is why it was given such name. The best game of the lure will be to interchange small accelerations and stops during reeling. At the beginning of the stop, most bites occur – stay focused! The OSS stabilization system perfectly orientates the lure in the water, regardless of whether there is current or not. Thanks to OSS all HAIRA TINY PLUS ONE wobblers show additional vibration during reeling and they have increased casting distance. The main targets of HAIRA TINY PLUS ONE are chub, trout, asp, perch, and pike.



ITEM NO.	MODEL	COLOR	TYPE	LENGTH (CM)	WEIGHT (G)	REC. BRAIDED LINE Ø (MM)	DEPTH (M)
HAT33LBF-***	Haira Tiny 33LBF	<b>147</b> , 148, 201, 202, 204, 205, 215, 301, 401, 402, 403, 404, 405, 406, 503, 504, 506	floating	3,3	4	0,09	1,0
HAT44LBF-***	Haira 44LBF	201, 202, 204, 205, 401, 402, 403, <b>404</b> , 405, 406, 503	floating	4,4	8	0,13	1,0

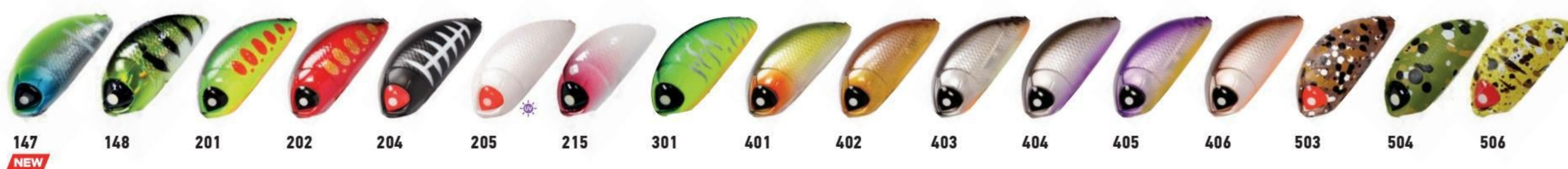

## HAIRA TINY 33 ATG PLUS FOOT

LJ HAIRA TINY 33 ATG PLUS FOOT – specially designed for pond trout fishing (ATG – Area Trout Game). Structurally different from the model Haira Tiny Plus One 33 LBF by lacking the magnetic systems OSS and MCS. HAIRA TINY 33 ATG PLUS FOOT available in floating version, size – 33 mm.



ITEM NO.	MODEL	COLOR	TYPE	LENGTH (CM)	WEIGHT (G)	REC. BRAIDED LINE Ø (MM)	DEPTH (M)
HATR33LBF-***	Haira Tiny ATG	801, 802, 803, 804, 805, 806, 904, 912	floating	3,3	4	0,09	0–1,0



## HAIRA TINY 33 ATG SHALLOW PILOT

LJ HAIRA TINY 33 ATG SHALLOW PILOT – specially designed for pond trout fishing (ATG – Area Trout Game). Structurally different from the model Haira Tiny Shallow Pilot 33F by lacking the magnetic systems OSS and MCS. HAIRA TINY 33 ATG SHALLOW PILOT available in floating version, size – 33 mm.



ITEM NO.	MODEL	COLOR	TYPE	LENGTH (CM)	WEIGHT (G)	REC. BRAIDED LINE Ø (MM)	DEPTH (M)
HATR33F-***	Haira Tiny ATG	801, 802, 803, 804, 806, 904, 912	floating	3,3	4	0,09	0–0,2

## BASARA 35LBF ATG

LJ BASARA 35LBF ATG – specially designed for pond trout fishing (ATG – Area Trout Game). Structurally different from the model Basara 35LBF ATG by lacking the magnetic systems OSS and MCS. BASARA 35LBF ATG available in floating version, size – 35 mm.



ITEM NO.	MODEL	COLOR	TYPE	LENGTH (CM)	WEIGHT (G)	REC. BRAIDED LINE Ø (MM)	DEPTH (M)
BATR35LBF-***	Basara ATG	801, 802, 803, 804, 805, 806, 904, 912	floating	3,5	2	0,064	0–0,6

## SAIKO 35F ATG

LJ SAIKO 35F ATG – specially designed for pond trout fishing (ATG – Area Trout Game). The combination of an interesting bent shape and a narrow lip gives a very unusual game that can provoke the most passive fish to bite. SAIKO 35FATG available floating version, size – 35 mm.



ITEM NO.	MODEL	COLOR	TYPE	LENGTH (CM)	WEIGHT (G)	DEPTH (M)
SATR35F-***	SAIKO ATG	507, 508, 509, 510, 511, 512, 513, 803, 806, 809, 810, 811	floating	3,5	2,5	0–2

## Surface

0,5

POP-X6F  
POP-X6,5F

POP-X9F

CHUBBY F

0,7

SHAD GRAFT  
5F

0,8

ARROW JERK  
8F

1,0m

ARROW JERK  
10F

ARROW JERK  
15F

1,2

SHAD GRAFT  
7F

MAGIC SINKERS  
10S

PILOT-X  
4,5F

ARROW JERK  
8S

1,5

2,0m

2,3

SHAD-X  
8F

2,5

3,0m

SHADY CRANK  
6F

3,2

SHAD-XDR  
8F

ARROW JERK  
15S

## POP-X 6,5F, 9F



LJ POP-X – popper type wobbler of the Lucky John Original series lures. Poppers belong to specific seasonal hard lures that are usable in particular fishing conditions. In the practice of spinning fishing, there are not so many effective surface baits, but poppers have become the most common for the water surfaces. Reviews of anglers about the POP-X wobbler are the most exciting. It is called a “super bait” – durable, excellent performance and easy to use. To cast this lure does not require special effort, it flies rapidly and accurately, easy to manage. When it enters the water, it creates a tempting sound effect that very much attracts fish. POP-X available in two sizes – 6,5 cm and 9,0 cm. The smaller size is more targeted for perch, asp, and chub fishing. The size of 9,0 cm is perfect for pike fishing.

ITEM NO.	MODEL	COLOR	TYPE	LENGTH (CM)	WEIGHT (G)	DEPTH (M)
LJ01006F-	POP-X F	013, A001, A007, A024, A026, A029, A037	floating	6,5	8	0
LJ01009F-	POP-X F	013, A001, A007, A024, A026, A029, A037	floating	9,0	13,0	0



# ARROW JERK

SHALLOW AND SINKING



**NEW**

## LJ BBS ARROW JERK 150

BBS ARROW JERK – a series of sinking and floating lures. Specifically designed for catching large predatory fish. The wobbler has a very distinctive game, therefore it is better to try it in shallow waters first. This will allow to choose the right leader, the strength of the jerks and the length of the pauses. BBS ARROW JERK will show its best potential on rhythmic, short jerks. The durable plastic and resistant coating will withstand pike teeth.



ITEM NO.	MODEL	COLOR	TYPE	LENGTH (CM)	DEPTH (M)
LJ00515F-***	ARROW JERK F	<b>003, 008, 017, 024, 025, 026, 027, 028, 029, 030, 031, 032</b>	floating	15,0	0-1,0
LJ00515S-	ARROW JERK S	<b>024, 025, 026, 027, 028, 029, 030, 031, 032</b>	sinking	15,0	0,5-4,0



## ARROW JERK 8F, 10F ARROW JERK 8S



LJ ARROW JERK – wobbler with an aggressive game that will attract large predators. The bait is available in two versions – floating and sinking. ARROW JERK comes in multiple colorings and 2 sizes – 8,0 cm and 10,0 cm. The main target of ARROW JERK is pike.

ITEM NO.	MODEL	COLOR	TYPE	LENGTH (CM)	WEIGHT (G)	DEPTH (M)
LJ00508F-	ARROW JERK F	001, 002, 003, 008, 011, 017, 018, 019, 020, 021, <b>024, 025, 026, 027, 028, 029</b>	floating	8,0	19,0	0-0,8
LJ00510F-***	ARROW JERK F	001, 002, 003, 005, 008, 011, 017, 018, 019, 020, 021, 022, <b>024, 025, 026, 027</b>	floating	10,0	34,0	0-1,0
LJ00508S-	ARROW JERK S	001, 002, 003, 006, 008, 018, 019, 021, <b>024, 025, 026, 027</b>	sinking	8,0	23	0,5-1,5



## CHUBBY F 4F



Chubby – the light weight hard body crankbait. Perfect search bait or one of the most used cranks for trout, asp and perch fishing in shallow waters. You can work the lure down to half a meter, and then slowly roll it back. It will work everywhere at any time.

ITEM NO.	MODEL	COLOR	TYPE	LENGTH (CM)	WEIGHT (G)	DEPTH (M)
LJ02004F-	CHUBBY F	002, 004, 009, 010, 011, 012, 013, 014, 015, 017, 018, 019, 020	floating	40	4	0,4



## PILOT-X 4,5F



LJ PILOT-X – a crank type wobbler with very active, original game. The lure is most effective at steady guiding. PILOT-X available in size 4,5 cm. Its main targets are perch, asp and chub.

ITEM NO.	MODEL	COLOR	TYPE	LENGTH (CM)	WEIGHT (G)	REC. BRAIDED LINE Ø (MM)	DEPTH (M)
LJ004045F-***	PILOT-X F	001, 002, 003, 005, 007, 008, 009, 013, 017	floating	4,5	8,0	0,13	0-1,2



## SHAD CRAFT 5F, 7F



LJ SHAD CRAFT – wobbler specially designed for pike fishing in still waters without currents. The shape of the wobbler is strongly flattened from the sides and it gives to the bait the original game. The wobbler shows excellent casting characteristics and bites' results. SHAD CRAFT available in floating version and 2 sizes – 5,0 cm; 7,0 cm.

ITEM NO.	MODEL	COLOR	TYPE	LENGTH (CM)	WEIGHT (G)	DEPTH (M)
LJ01105F-	SHAD CRAFT F	A024, A026, A029, A037	floating	5,0	5	0-0,6
LJ01107F-	SHAD CRAFT F	A001, A007, A024, A026, A029	floating	7,0	11,0	0-1,0





## SHADY CRANK 6F



LJ SHADY CRANK – universal floating wobbler for fishing in deep waters with depths greater than 3 meters. It floats steady at any speed, which makes possible to use it in various fishing conditions. The excellent casting characteristics of the wobbler expand the fishing area and allow targeted casting. By changing the guiding speed, the bait is suitable for catching both active and passive fish. SHADY CRANK available in size – 6,0 cm.

ITEM NO.	MODEL	COLOR	TYPE	LENGTH (CM)	WEIGHT (G)	DEPTH (M)
LJ01206F-	SHADY CRANK F	A007, A026, A029, A037	floating	6,0	12,0	0–2,8



## SHAD-X 8F SHAD-XDR 8F



LJ SHAD-X/SHAD-XDR – wobblers for a wide variety of fishing types and conditions. Due to the active game, they are perfectly usable both for twitching and for smooth guiding. Available in size 8,0 cm and two depth versions – up to 1,2 m – SHAD-X and up to 2,5 m – SHAD-XDR.

ITEM NO.	MODEL	COLOR	TYPE	LENGTH (CM)	WEIGHT (G)	REC. BRAIDED LINE Ø (MM)	DEPTH (M)	ENC
LJ00308F-***	SHAD-X	001, 002, 003, 004, 005, 006, 007, 008, 009	floating	8,0	12,0	0,15–0,17	0–1,2	1,81
LJ00308FDR-***	SHAD-XDR	004, 005, 006, 007, 008, 009, 010, 011, 012, 017	floating	8,0	14,0	0,15–0,17	0–2,5	1,81



## MAGIC SINKER 10S



LJ MAGIC SINKER – a highly functional wobbler for twitching. This sinking lure is very effective for predator fishing at 2–3 meters depth, even with fast guiding. With light jerking and stronger twitching MAGIC SINKER imitates a small fish hiding from danger. The small balls that are embedded in the body of the lure create sound that will provoke even the most passive predators. The main target of MAGIC SINKER are pike and zander. MAGIC SINKER is available in size 10,0 cm.

ITEM NO.	MODEL	COLOR	TYPE	LENGTH (CM)	WEIGHT (G)	REC. BRAIDED LINE Ø (MM)	DEPTH (M)
LJ00610S-***	Magic sinkers S	A19, A22, M03, S89	sinking	10,0	15,0	0,13–0,15	0–1,5



## SPINNERS LUCKY JOHN BONNIE BLADE



LJ BONNIE BLADE - series of spinners with an oval blade. These lures have stable and reliable action that attracts predators. The blade is lightweight, made of brass, and has good dynamics when rotating in the water. The blades are painted from both sides. All treble hooks have fixed bright fly which hides the hook and helps to stabilize spinner in the water. BONNIE BLADE has two types of weights – with balls and cylindrical. The main targets of BONNIE BLADE are perch, pike, trout, and salmon. BONNIE BLADE available in six weights – 2,7; 3,5; 4,3; 6,4; 10,3 and 13,4 grams.

ITEM NO.	COLOR	WEIGHT (G)	Q-TY IN PACKAGE (PCS.)
LJBB00-***	001, 002, 003, 004, 006, 007, 008, 009, 010, 011	2,7	1
LJBB01-***	001, 002, 003, 004, 006, 007, 008, 009, 010, 011	3,5	1
LJBB02-***	001, 002, 003, 004, 006, 007, 008, 009, 010, 011	4,3	1
LJBB03-***	001, 002, 003, 004, 006, 007, 008, 009, 010, 011	6,4	1
LJBB04-***	001, 002, 003, 004, 006, 007, 008, 009, 010, 011	10,3	1
LJBB05-***	001, 002, 003, 004, 006, 007, 008, 009, 010, 011	13,4	1



## SPINNERS LUCKY JOHN SHELT BLADE



LJ SHELT BLADE -- series of spinners with a "long" blade. These lures have stable and reliable action that attracts predators. It is lightweight, made of brass, and has good dynamics when rotating in the water. The blades are painted from both sides. All treble hooks have fixed bright fly which hides the hook and helps to stabilize spinner in the water. SHELT BLADE available in five weights – 3, 5, 9, 12 and 15 grams

ITEM NO.	COLOR	WEIGHT (G)	Q-TY IN PACKAGE (PCS.)
LJSB00-***	001; 002; 003; 008; 009; 010; 011	3	1
LJSB01-***	001; 002; 003; 006; 007; 008; 009; 010; 011	5	1
LJSB02-***	001; 002; 003; 006; 007; 008; 009; 010; 011	9	1
LJSB03-***	001; 002; 003; 006; 007; 008; 009; 010; 011	12	1
LJSB04-***	001; 002; 003; 006; 007; 008; 009; 010; 011	15	1



## SPINNERS LUCKY JOHN TRIAN BLADE ROUND



LJ TRIAN BLADE ROUND – series of spinners with a classic oval blade. These lures have stable and reliable action that attracts any predators. The blade is made of brass and it is painted from both sides. The rotation angle of the blade is 60 degrees. The body of the spinner is made of heavy alloy that ensures additional casting distance. The body also has specific geometric shape that reduces fishing line twisting. All treble hooks have fixed bright fly which hides the hook and helps to stabilize spinner in the water. TRIAN BLADE ROUND is available in four weights – 6, 9, 12 and 18 grams.

ITEM NO.	COLOR	WEIGHT (G)	Q-TY IN PACKAGE (PCS.)
LJTBR6-***	001; 002; 003; 004; 005; 006; 007; 008	6	1
LJTBR9-***	001; 002; 003; 004; 005; 006; 007; 008	9	1
LJTBR12-***	001; 002; 003; 004; 006; 008	12	1
LJTBR18-***	001; 002; 003; 004; 006; 008	18	1



## SPINNERS LUCKY JOHN TRIAN BLADE LONG



LJ TRIAN BLADE LONG – series of spinners with a classic shape. These lures have stable and reliable action that attracts any predators. The blade is made of brass and has small holes that help to make additional swings. The rotation angle of the blade is 30 degrees which allows to use this spinner in strong currents. The body of the spinner is made of heavy alloy that ensures additional casting distance. The body also has specific geometric shape that reduces fishing line twisting. All treble hooks have fixed bright fly which hides the hook and helps to stabilize spinner in the water. TRIAN BLADE LONG is available in two weights – 6 and 9 grams.

ITEM NO.	COLOR	WEIGHT (G)	Q-TY IN PACKAGE (PCS.)
LJTBL6-***	001; 002; 003; 004; 005; 006; 007; 008	6	1
LJTBL9-***	001; 002; 003; 004; 005; 006; 007; 008	9	1



## LUCKY JOHN BELL SPIN

A classic spinner with a round, elongated «comet» shape blade. It has a specific cone-shaped core that looks like a bell. During the action in the water, it creates low-frequency sound that helps to attract the fish. The shape of the spinner body significantly reduces the fishing line twisting. The rotation angle of the blade is 45°. It is recommended to use this spinner in calm waters and in rivers with a weak and medium currents.

**NEW**



ITEM	COLOR	WEIGHT (G)	Q-TY IN PACKAGE (PCS.)
LJBS02-***	<b>BRD, C, CRD, G, GRD, S, SRD</b>	6	1
LJBS02-001SET	<b>BRD/GRD/SRD</b>	6	3
LJBS02-002SET	<b>C/G/S</b>	6	3
LJBS03-***	<b>BRD, C, CRD, G, GRD, S, SRD</b>	8	1
LJBS03-001SET	<b>BRD/GRD/SRD</b>	8	3
LJBS03-002SET	<b>C/G/S</b>	8	3
LJBS04-***	<b>BRD, C, CRD, G, GRD, S, SRD</b>	10	1
LJBS04-001SET	<b>BRD/GRD/SRD</b>	10	3
LJBS04-002SET	<b>C/G/S</b>	10	3



## LUCKY JOHN BASARA TAIL SPIN

**NEW**



BASARA TAIL SPIN is a super versatile long casting lure. The main advantage of the spinner is the casting distance and various retrieving options. Great action on the drop and on retrieve – the lure vibrates and flashes at the same time provoking the fish to strike hard. Cast and retrieve in various speeds and let fall on a tight line occasionally. BASARA TAIL SPIN available in 3 weights – 8, 14 and 21 grams.

ITEM NO.	COLOR	WEIGHT (G)	Q-TY IN PACKAGE (PCS.)
LJBTS08-***	001, 002, 003, 004, 005, 006	8,0	1
LJBTS14-***	001, 002, 003, 004, 005, 006	14,0	1
LJBTS21-***	001, 002, 003, 004, 005, 006	21,0	1



## LUCKY JOHN SPIN X LONG

LJ SPIN X LONG – classic spinner with elongated “long” blade. The lure has stable and reliable action that attracts predators. The blade is made of brass and has a corrosion protective nickel coating. The rotation angle of the blade is 30 degrees which allows to use this spinner in strong currents. The spinners have cylindric, brass weights. Treble hooks have fixed bright fly which hides the hook and helps to stabilize spinner in the water. SPIN X LONG available in four weights – 4; 6; 9 and 12 grams.

ITEM NO.	COLOR	WEIGHT (G)	Q-TY IN PACKAGE (PCS.)
LJSL02-***	BF; CR; FT; GR; SR, <b>GX, SX</b>	4	1
LJSL03-***	BF; CR; FT; GR; SR, <b>GX, SX</b>	6	1
LJSL04-***	BF; CR; FT; GR; SR, <b>GX, SX</b>	9	1
LJSL05-***	BF; CR; FT; GR; SR, <b>GX, SX</b>	12	1
<b>NEW</b> LJSL05-001SET	<b>CR/GR/SR</b>	12.0	3

## LUCKY JOHN SPIN X ROUND

LJ SPIN X ROUND – classic, universal spinner with rounded elongated blade. The lure has stable and reliable action that attracts predators. The blade is made of brass and has a corrosion protective nickel coating. The rotation angle of the blade is 45 degrees. The spinner can be used in still waters and in rivers with low or medium currents. The spinners have cylindric, brass weights. Treble hooks have fixed bright fly which hides the hook and helps to stabilize spinner in the water. SPIN X ROUND available in four weights – 3,5; 5; 8 and 11 grams.

ITEM NO.	COLOR	WEIGHT (G)	Q-TY IN PACKAGE (PCS.)
LJSR01-***	BF; CR; FT; GR; SR, <b>GX, SX</b>	3,5	1
LJSR02-***	BF; CR; FT; GR; SR, <b>GX, SX</b>	5	1
LJSR03-***	BF; CR; FT; GR; SR, <b>GX, SX</b>	8	1
LJSR04-***	BF; CR; FT; GR; SR, <b>GX, SX</b>	11	1
<b>NEW</b> LJSR03-001SET	<b>CR/GR/SR</b>	8.0	3
<b>NEW</b> LJSR04-001SET	<b>CR/GR/SR</b>	11.0	3



## LUCKY JOHN SPINNER BAITS

LJ SPINNER BAITS – artificial lure that consists of two blades, single hook and ultra-fine silicone skirt that creates superb action. The main target of SPINNER BAITS are pike and large perch. SPINNER BAITS available in four weights – 10; 14; 18 and 22 grams.



ITEM NO.	COLOR	WEIGHT (G)
LJSH01-***	001, 002, 003, <b>04, 05</b>	10
LJSH02-***	001, 002, 003, <b>04, 05</b>	14
LJSH03-***	001, 002, 003, <b>04, 05</b>	18
LJSH04-***	001, 002, 003, <b>04, 05</b>	22

## SPOON-BAITS LUCKY JOHN EOS



LJ EOS – spoon bait series for trout fishing with ultra-light and light spinning rods. These spoon baits are perfect for trout fishing in ponds, natural waters and in rivers with medium currents at shallow depth. EOS spoon bait has concaved profile with a special tail bend, which gives it a unique action. When guiding, the lure moves very straight without wide swings from side to side - its movements look like a game of crankbait type wobblers. Due to its light weight, it is possible to guide the lure on the very surface of the water. EOS available in five weights – 1.8; 2.4; 3.5; 5 and 8 grams.

ITEM NO.	COLOR	WEIGHT (G)	LENGTH (MM)	HOOK TYPE
LJEOS18-***	002; 003; 004; 005; 010; 011; 012; 014; 018; 019	1,8	25	single hook
LJEOS24-***	002; 003; 004; 005; 010; 011; 012; 018; 019	2,4	29	single hook
LJEOS35-***	002; 003; 004; 005; 010; 011; 012; 018; 019	3,5	33	single hook
LJEOS50-***	002; 003; 004; 005; 010; 011; 012; 018; 019	5	39	single hook
LJEOS80-***	002; 003; 004; 005; 010; 011; 012; 018; 019	8	44	trable hook



## SPOON-BAITS LUCKY JOHN JUNA

AREA  
*Trout*  
GAME



ITEM NO.	COLOR	WEIGHT (G)	LENGTH (MM)
LJJU18-***	021, 023, 024, 025, 026, 028, 029, 032, 033	1,8	26
LJJU25-***	020, 021, 023, 024, 025, 026, 028, 029, 032, 033	2,5	30
LJJU35-***	020, 021, 029, 032, 033	3,5	33



## SPOON-BAITS LUCKY JOHN PEPA

AREA  
*Trout*  
GAME



ITEM NO.	COLOR	WEIGHT (G)	LENGTH (MM)
LJPE22-***	002, 011, 012, 014, 015, 033, 034, 035, 041, 043	2,2	25





EFTTEX AWARD  
2019



## Best New Product Runner Up Awards EFTTEX 2019

SOFT/DOUGH BAIT CATEGORY



### SALT WORM 2,0"



LJ SALT WORM – passive soft plastic bait imitating round sea worm. The lure created for saltwater rock fishing, very effective for micro jigging. The lure is made of dense elastic polymer and can withstand many bites. SALT WORM is impregnated with a particularly powerful attractor – strong seafood scent. The lure available in size – 2" (5 cm).



ITEM NR.	COLORS	LENGHT	SCENT	Q-TY
140178-***	033; 309; F03; S30; S31; S32	2,0/5,0	seafood	12



### AYING TAIL 2,0"



LJ AYING TAIL – passive soft plastic bait imitating round sea worm. The lure created for saltwater rock fishing, very effective for micro jigging. The lure is made of dense elastic polymer and can withstand many bites. AYING TAIL is impregnated with a particularly powerful attractor – strong seafood scent. The lure available in size – 2" (5 cm) – small enough for crappie and larger bluegills, but also large enough to interest trout and bass as big as you'd want to catch on your ultralight spinning rod.



ITEM NR.	COLORS	LENGHT	SCENT	Q-TY
140179-***	033; 309; F03; S30; S31; S32	2,0/5,0	seafood	12





## SANDWORM 2"/4"



# SALTY SENSATION



LJ SANDWORM – passive soft plastic bait imitating sand worm. The lure created for saltwater rock fishing, very effective for micro jigging. A long bait can be cut into pieces of the required length. The lure is made of dense elastic polymer and can withstand many bites. SANDWORM is impregnated with a particularly powerful attractor – shrimp with strong raspberry scent. The specific material formula allows to provoke passive fish – either predators or peaceful ones. The lure available in two sizes – 2" (5 cm) and 4" (10 cm).

SANDWORM – Best New Product Runner Up 2019-2020 Award Winner at EFTTEX 2019.

ITEM NO.	COLOR	LENGTH ("/CM)	ATTRACTANT	Q-TY IN PACKAGE (PCS.)
140501-**	F05, F29N, F33, F40, F41	2,0/5,0	Raspberries	24
140502-**	F05, F29N, F33, F40, F41	4,0/10,0	Raspberries	15



## LUGWORM 2,5"/4,5"



# SALTY SENSATION



LJ LUGWORM – passive soft plastic bait imitating Nereis sea worm. The lure created for saltwater rock fishing, very effective for micro jigging. A long bait can be cut into pieces of the required length. LUGWORM is impregnated with a particularly powerful attractor – strong squid scent. The specific material formula allows to provoke passive fish – either predators or peaceful ones. The lure available in two sizes – 2,5" (6,35 cm) and 4,5" (11,4 cm).

ITEM NO.	COLOR	LENGTH ("/CM)	ATTRACTANT	Q-TY IN PACKAGE (PCS.)
140503-**	F05, F29N, F33, F40, F41	2,5/6,35	Squid	24
140504-**	F05, F29N, F33, F40, F41	4,5/11,4	Squid	15

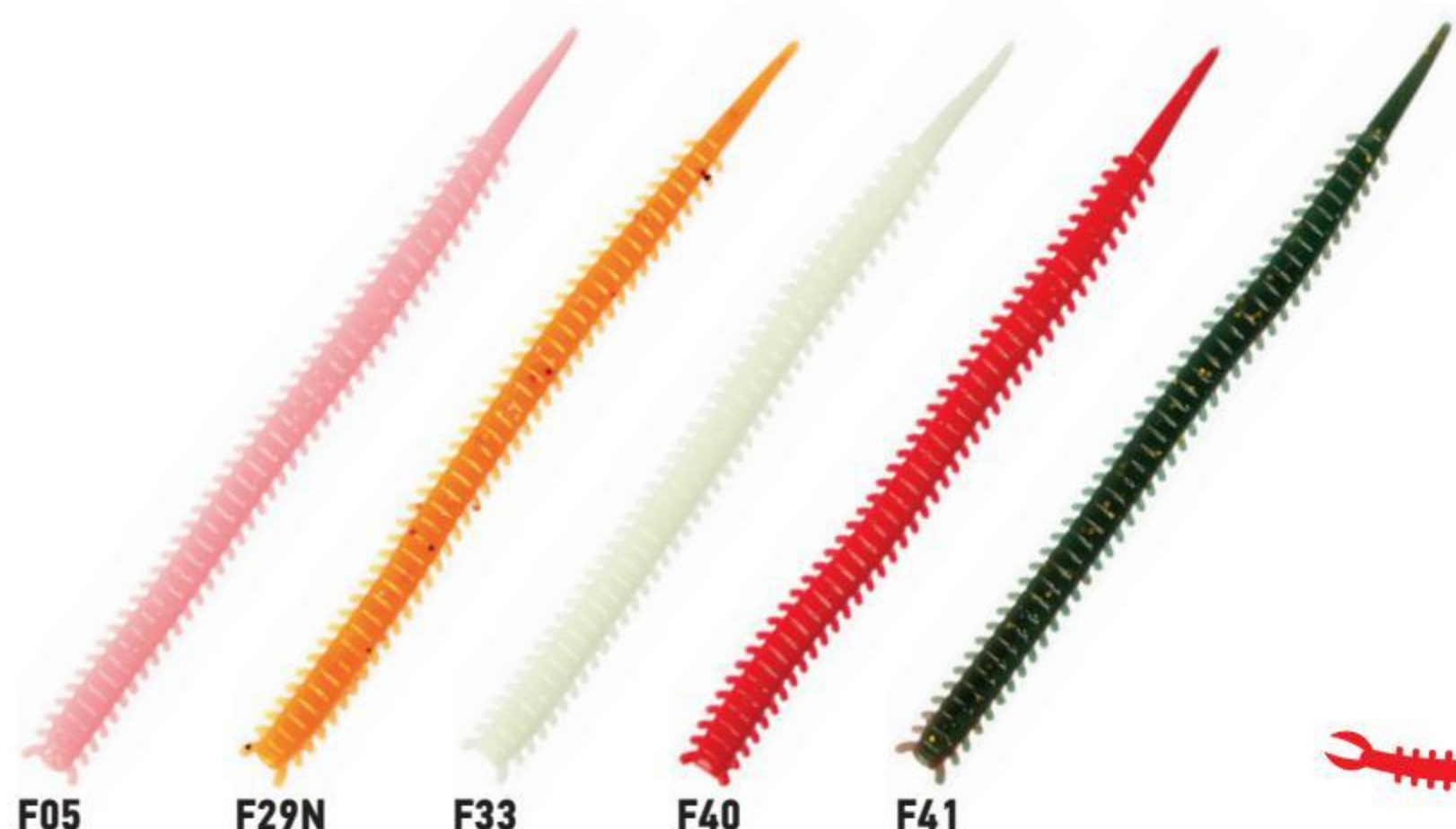

## SALT MINNOW 175 F/S, 210F/S



LJ SALT MINNOW – specially designed series of large wobblers for predators' fishing in salt water. Equipped with strong three treble hooks. The wobbler available in sinking and floating versions and two sizes – 17,5 cm and 21,0 cm.



ITEM NO.	COLOR	TYPE	LENGTH (CM)	WEIGHT (G)	DEPTH (M)
SM175F-***	001, 002, 003, 004, 005, 006	Floating	17,5	21	0-1
SM175S-***	001, 002, 003, 004, 005, 006	Sinking	17,5	24	0,5-2
SM210F-***	001, 002, 003, 004, 005, 006	Floating	21,0	38	0-1,2
SM210S-***	001, 002, 003, 004, 005, 006	Sinking	21,0	45	0,7-3

## LUCKY JOHN BASARA JIGGER



Basara Jigger is developed for long casting and corresponds to various actions. The shape of the lure helps to control the friction while jerking against the water. Basara Jigger may target various fish – Yellowtails, Dorado, Small Tuna, Mackerel, Seabass & etc. Perfect for saltwater shore fishing!

ITEM NO.	COLOR	WEIGHT (G)
LJSBJ5-***	003, 004, 005, 006, 008, 009	5
LJSBJ8-***	003, 004, 005, 006, 008, 009	8
LJSBJ12-***	003, 004, 005, 006, 008, 009	12
LJSBJ20-***	003, 004, 005, 006, 008, 009	20
LJSBJ40-***	003, 004, 005, 006, 008, 009	40
LJSBJ60-***	003, 004, 005, 006, 008, 009	60
LJSBJ80-***	003, 004, 005, 006, 008, 009	80
LJSBJ100-***	003, 004, 005, 006, 008, 009	100



## BASARA JIGGER ASSIST HOOKS



Basara Jigger Assist hooks have been designed for use with Basara jigs. Their size and shape makes them into the necessary accessory for light rock fishing and light shore jigs. Ready to use!

ITEM NO.	HOOK STYLE&SIZE	QTY IN PACKAGE (PCS.)
LJSAHS-007	ISEAMA #7Tin	3
LJSAHS-008	ISEAMA #8Tin	3
LJSAHS-010	ISEAMA #10Tin	3
LJSAHS-012	ISEAMA #12Tin	3
LJSAHS-013	ISEAMA #13Tin	3
LJSAHS-014	ISEAMA #14Tin	3
LJSAHS-015	ISEAMA #15Tin	3
LJSAHD-013	ISEAMA #13Tin	1
LJSAHD-014	ISEAMA #14Tin	1

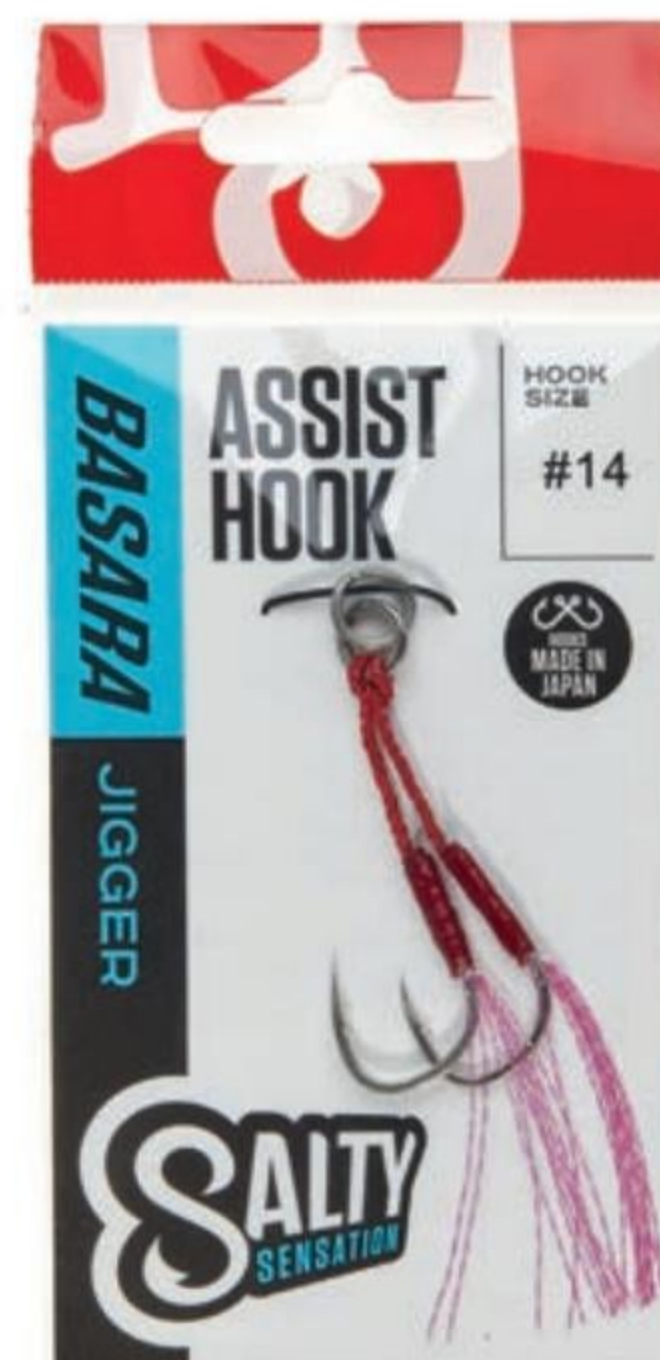

## JIGHEAD LUCKY JOHN MONSTER JIG

LJ MONSTER JIG – jig heads developed for predator fishing and use with all Lucky John plastic soft lures. Comes in resealable package. 10 hook sizes and wide weight range available.



#4, #2, #1, #4/0, #1/0, #2/0, #3/0, #5/0

ITEM. NO	WEIGHT (OZ/G)	HOOK SIZE	Q-TY PER PACK
MLJ08-***	002, 003	8	5
MLJ06-***	002, 003, 004	6	5
MLJ04-***	002, 003, 004, 005, 006	4	5
MLJ02-***	002, 003, 004, 005, 007, 009	2	5
MLJ01-***	002, 003, 004, 005, 007, 009	1	5
MLJ10-***	003, 005, 007, 010, 012, 015	1/0	4
MLJ20-***	003, 005, 007, 010, 012, 015	2/0	4
MLJ30-***	003, 005, 007, 010, 012, 015, 020	3/0	3
MLJ40-***	003, 005, 007, 010, 012, 015, 020	4/0	3
MLJ50-***	003, 005, 007, 010, 012, 015, 020	5/0	3

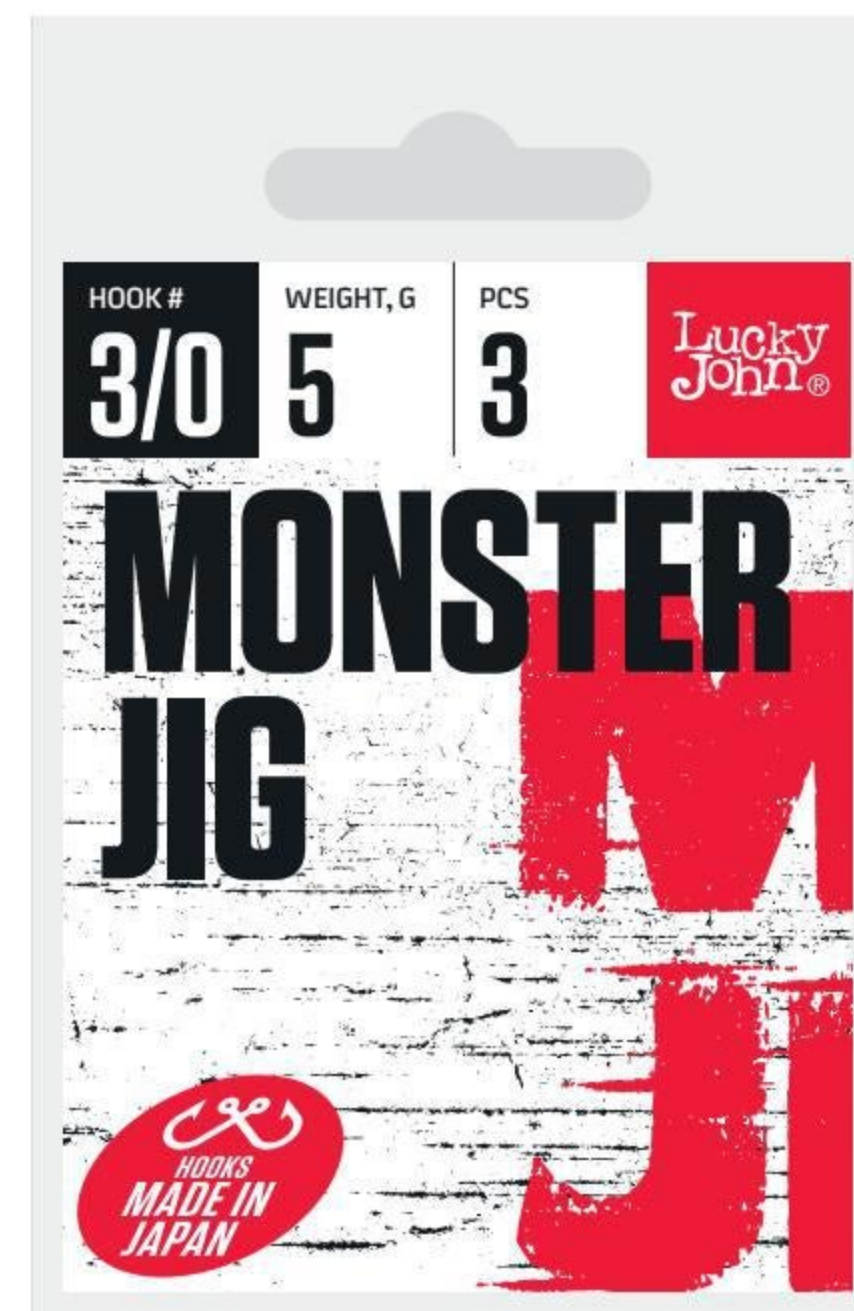

## JIGHEAD LUCKY JOHN MJ ROUND HEAD

Jig heads developed for predator fishing and use with all plastic soft lures. Light jiggling and rock fishing special.

Light Jiggling  
& Rock Fishing special



ITEM NO.	MODEL	WEIGHT (G)	HOOK SIZE #	QTY PER PACK	TYPE
LJMJ01-****	0020; 0030; 0040; 0050; 0070; 0090	2; 3; 4; 5; 7; 9	1	25	zip-lock
LJMJ02-****	0020; 0030; 0040; 0050; 0070; 0090	2; 3; 4; 5; 7; 9	2	25	zip-lock
LJMJ04-****	0020; 0030; 0040; 0050; 0060; 0070	2; 3; 4; 5; 6; 7	4	25	zip-lock
LJMJ06-****	0015; 0020; 0025; 0030; 0035	1,5; 2; 2,5; 3; 3,5	6	25	zip-lock
LJMJ08-****	0015; 0020; 0025; 0030; 0035	1,5; 2; 2,5; 3; 3,5	8	25	zip-lock
LJMJ10-****	0010; 0015	1; 1,5	10	25	zip-lock

## JIGHEAD LUCKY JOHN ROUND HEAD

Jig heads developed for predator fishing and use with all plastic soft lures. Light jiggling and rock fishing special.

Light Jiggling  
& Rock Fishing special



ITEM NO.	MODEL	WEIGHT (G)	HOOK SIZE #	QTY PER PACK	TYPE
LJJ10-****	0030; 0050; 0070; 0100; 0120; 0150	3; 5; 7; 10; 12; 15	1/0	10	zip-lock
LJJ20-****	0030; 0050; 0070; 0100; 0120; 0150; 0170;	3; 5; 7; 10; 12; 15; 17;	2/0	10	zip-lock
LJJ20-****	0200; 0250; 0300	20; 25; 30	2/0	5	zip-lock
LJJ30-****	0030; 0050; 0070; 0100; 0120; 0150; 0170;	3; 5; 7; 10; 12; 15; 17;	3/0	10	zip-lock
LJJ30-****	0200; 0250; 0300; 0350; 0400	20; 25; 30; 35; 40	3/0	5	zip-lock
LJJ50-****	0030; 0050; 0070; 0100; 0120; 0150; 0170;	3; 5; 7; 10; 12; 15; 17;	5/0	10	zip-lock
LJJ50-****	0200; 0250; 0300; 0350; 0400	20; 25; 30; 35; 40	5/0	5	zip-lock

## GOLIATH JIG JUNIOR

ITEM NO.	HOOK SIZE	WEIGHT (G)	QTY IN PACKAGE (PCS.)
LJJ070-0050	7/0	5	3
LJJ070-0080	7/0	8	3
LJJ070-0120	7/0	12	3
LJJ080-0050	8/0	5	3
LJJ080-0080	8/0	8	3
LJJ080-0120	8/0	12	3
LJJ100-0050	10/0	5	2
LJJ100-0080	10/0	8	2
LJJ100-0120	10/0	12	2
LJJ120-0050	12/0	5	2
LJJ120-0080	12/0	8	2
LJJ120-0120	12/0	12	2
LJJ070-0160	7/0	16	3
LJJ080-0160	8/0	16	3
LJJ010-0160	10/0	16	2
LJJ012-0160	12/0	16	2
LJJ014-0080	14/0	8	2
LJJ014-0120	14/0	12	2
LJJ014-0160	14/0	16	2

Classic jig head with a large single hook. Developed for use with any plastic soft lures.

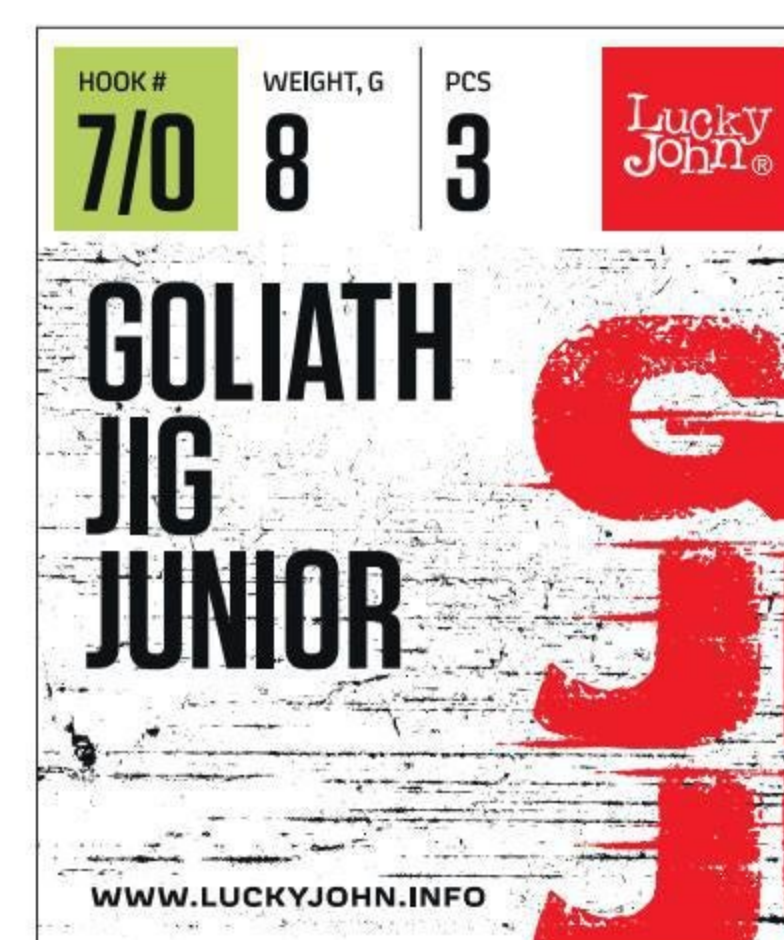

## STAND UP JIG HEAD

Lead jig heads developed for use with any plastic soft lures. Available four hook sizes and five weights.



ITEM NO.	WEIGHT (G)	HOOK SIZE	Q-TY IN PACKAGE (PCS.)
LJSAJ02-	3, 5,	2	5
LJSAJ01-	3, 5, 7	1	5
LJSAJ30-	3, 5, 7, 9,	0/3	4
LJSAJ50-	3, 5, 7, 9, 12,	0/5	4 (12 g 3 pcs)

## TUNGSTEN, DISMOUNTABLE LUCKY JOHN TUNGSTEN JIG BALL

Compact dismountable tungsten jig ball.



ITEM NO.	WEIGHT (G)	QTY IN PACKAGE (PCS.)
LJTB-001	1	5
LJTB-001BN	1	5
LJTB-001G	1	5
LJTB-003	3	3
LJTB-003BN	3	2
LJTB-003G	3	2
LJTB-005	5	2
LJTB-005BN	5	2
LJTB-005G	5	2
LJTB-007	7	2
LJTB-007BN	7	2
LJTB-007G	7	2
LJTB-009	9	1
LJTB-012	12	1

## LEAD, DISMOUNTABLE LUCKY JOHN JIG BALL

Compact dismountable lead jig ball.



ITEM NO.	WEIGHT (G)	QTY IN PACKAGE (PCS.)
LJJB-003	3	5
LJJB-005	5	5
LJJB-007	7	5
LJJB-010	10	4
LJJB-014	14	4
LJJB-018	18	4
LJJB-022	22	3

## LUCKY JOHN DEEP PIKE STINGER RIG L+FLEXHEAD

**NEW**

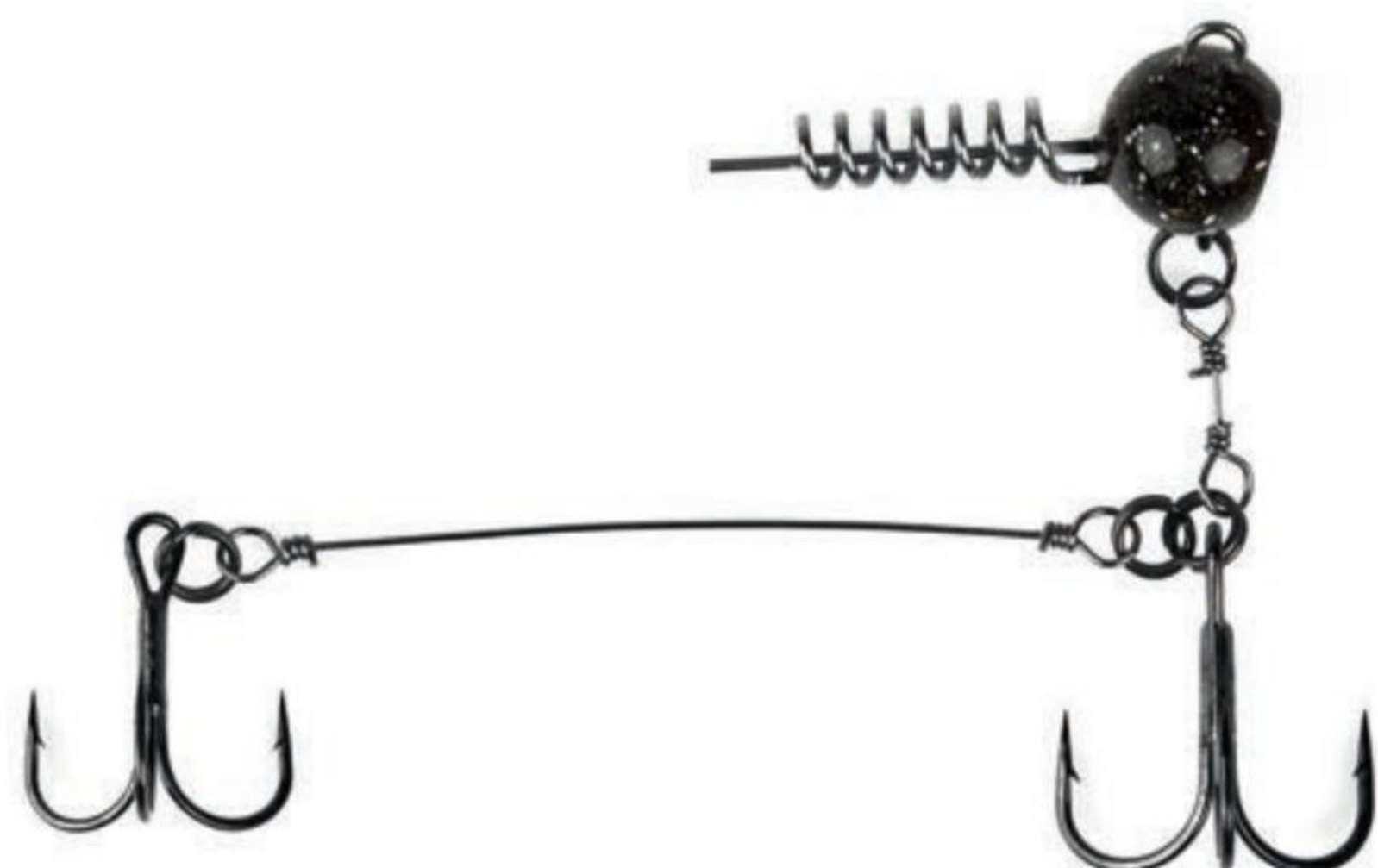

ITEM NO.	SIZE	HOOK	WEIGHT (G)	Q-TY IN PACKAGE (PCS.)
LJP7403-L010	L	#1/0 +#1	10	1
LJP7403-L015	L	#1/0 +#1	15	1

## LUCKY JOHN BBS WOBBLING FLEXHEAD PIKE

**NEW**

Lucky John Wobbling Flexhead Pike is made for rigging softbaits especially for Kubira, Giant Kubira and Kubira Fire Tail big size lures.



ITEM NO.	COLOR	SIZE (G)	Q-TY IN PACKAGE (PCS.)
LJWFP10-***	002, 003	10,0	3
LJWFP15-***	002, 003	15,0	2
LJWFP21-***	002, 003	21,0	2
LJWFP28-***	002, 003	28,0	2

## LUCKY JOHN BRASS BULLET

Bullet shape brass sinker.



ITEM NO.	WEIGHT (G)	QTY IN PACKAGE (PCS.)
LJBUL-0035	3,5	7
LJBUL-0050	5	6
LJBUL-0070	7	5
LJBUL-0100	10	4
LJBUL-0140	14	3

## CORKSCREW ROUNDS BALL JIGHEAD

Jig heads developed for predator fishing and various use of plastic soft lures. Suitable for different spinning systems.



ITEM NO.	WEIGHT (G)	Q-TY IN PACKAGE
LJCJ-008	8	6
LJCJ-012	12	5
LJCJ-016	16	4
LJCJ-020	20	3

## OFFSET HOOKS PREDATOR LJH357

Offset hook with a spiral mount and additional weight. Simple and reliable hook installation into the bait. Additional hook weight allows to fish in overgrown waters.

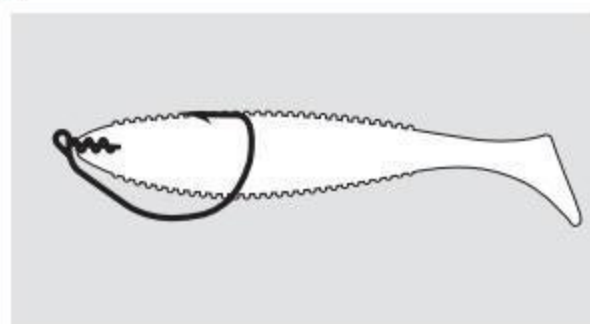

ITEM NO.	SIZE	Q-TY IN PACKAGE (PCS.)	LEAD WIGHT (G)
LJH357-K040	4/0	3	3,5
LJH357-K060	6/0	3	7
LJH357-K080	8/0	2	10
LJH357-K100	10/0	2	14

## LUCKY JOHN DROP SHOT LONG

Elongated dropshot sinker.

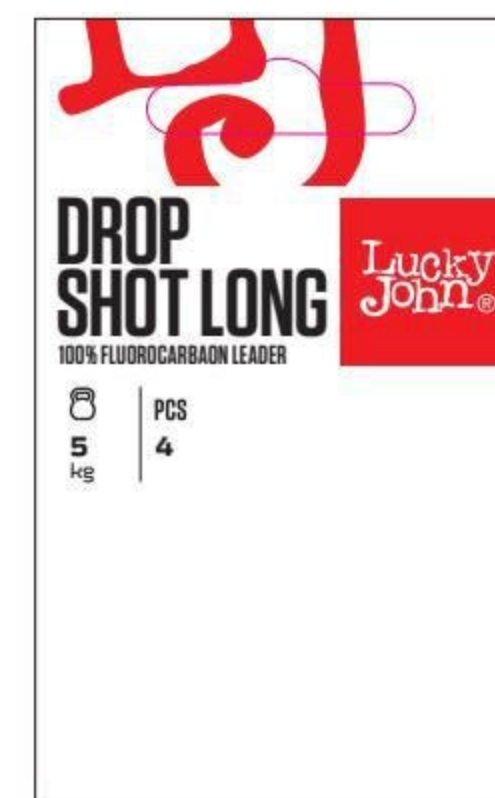

ITEM NR.	WEIGHT G	PCS IN PACKAGING
LJDS-005	5	4
LJDS-007	7	4
LJDS-010	10	4
LJDS-015	15	3
LJDS-020	20	3
LJDS-025	25	2

## OFFSET HOOKS PREDATOR LJH356

Offset hook with a spiral mount that provides simple and reliable hook installation into the bait.

Color: NSB

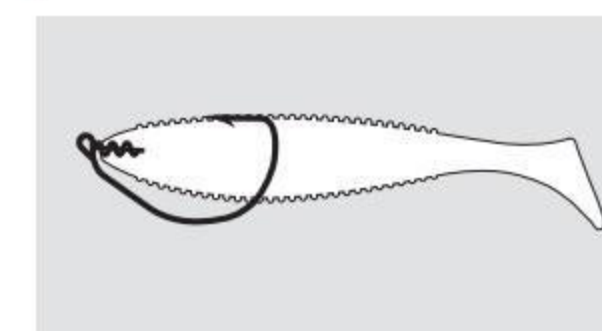

ITEM NO.	SIZE	Q-TY IN PACKAGE (PCS.)
LJH356-K040	4/0	3
LJH356-K060	6/0	3
LJH356-K060	8/0	2
LJH356-K080	10/0	2
LJH356-K120	12/0	2

## OFFSET HOOKS PREDATOR LJH358

Offset hook with a spiral mount and additional weight. Simple and reliable hook installation into the bait. Additional hook weight allows to fish in overgrown waters.

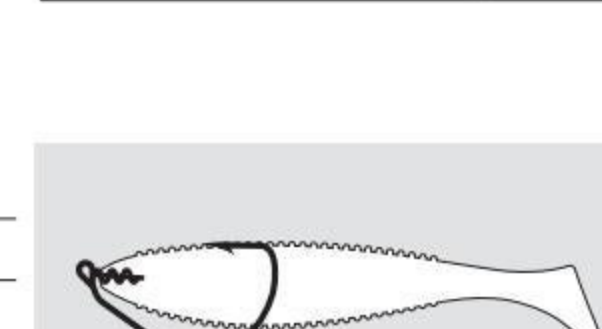

ITEM NO.	SIZE	Q-TY IN PACKAGE (PCS.)	LEAD WIGHT (G)
LJH358-S040	4/0	2	3
LJH358-S060	6/0	1	5
LJH358-S080	8/0	1	7,5
LJH358-S100	10/0	1	10

## TRAILER HOOK FOR LUCKY JOHN FROG

The trailer hook is designed to put on the double hooks of Lucky John FROG. An additional trailer hook significantly increases the bites of predator fish. Size L suitable for 2" (5 cm) and 2,6" (6,5 cm) FORGS.



ITEM NO.	SIZE	Q-TY IN PACKAGE (PCS.)
LJPTH-001	L	2

## STINGER SYSTEM SSW 1X7



ITEM NO.	STINGER SIZE	STINGER SPECIFICATION	# TREBLE HOOK	TEST KG	PCS/PACK
LJP7401-XL	XL	1x7, Ø0,60 mm, 3,5 + 8,0 cm	2/0	54	1
LJP7401-L	L	1x7, Ø0,60 mm, 3,5 + 7,0 cm	1/0	48	1
LJP7401-M	M	1x7, Ø0,52 mm, 3,5 + 5,5 cm	1	42	1
LJP7401-S	S	1x7, Ø0,52 mm, 3,5 + 4,5 cm	1	36	1

## LEADER STINGER POWER CHAIN



ITEM NO.	STINGER SIZE	LURE IN/CM	TREBLE HOOK #	TEST KG	PCS/PACK
LJP7402-L	M	Up to 7"/18 cm	#1/0 + #1/0	32 kg	1
LJP7402-M	L	Up to 9"/23 cm	#2/0 + 1/0	45 kg	1
LJP7402-XL	XL	Up to 11"/28 cm	#3/0 + #2/0	58 kg	1

## STINGER SYSTEM SSW 1X7



ITEM NO.	STINGER SIZE	STINGER SPECIFICATION	# TREBLE HOOK	TEST KG	PCS/PACK
LJP7402-SS	SS	1x7, Ø0,47 mm, 5,5 cm	2	30	2
LJP7404-SSS	SSS	1x7, Ø0,47 mm, 4 cm	4	22	2

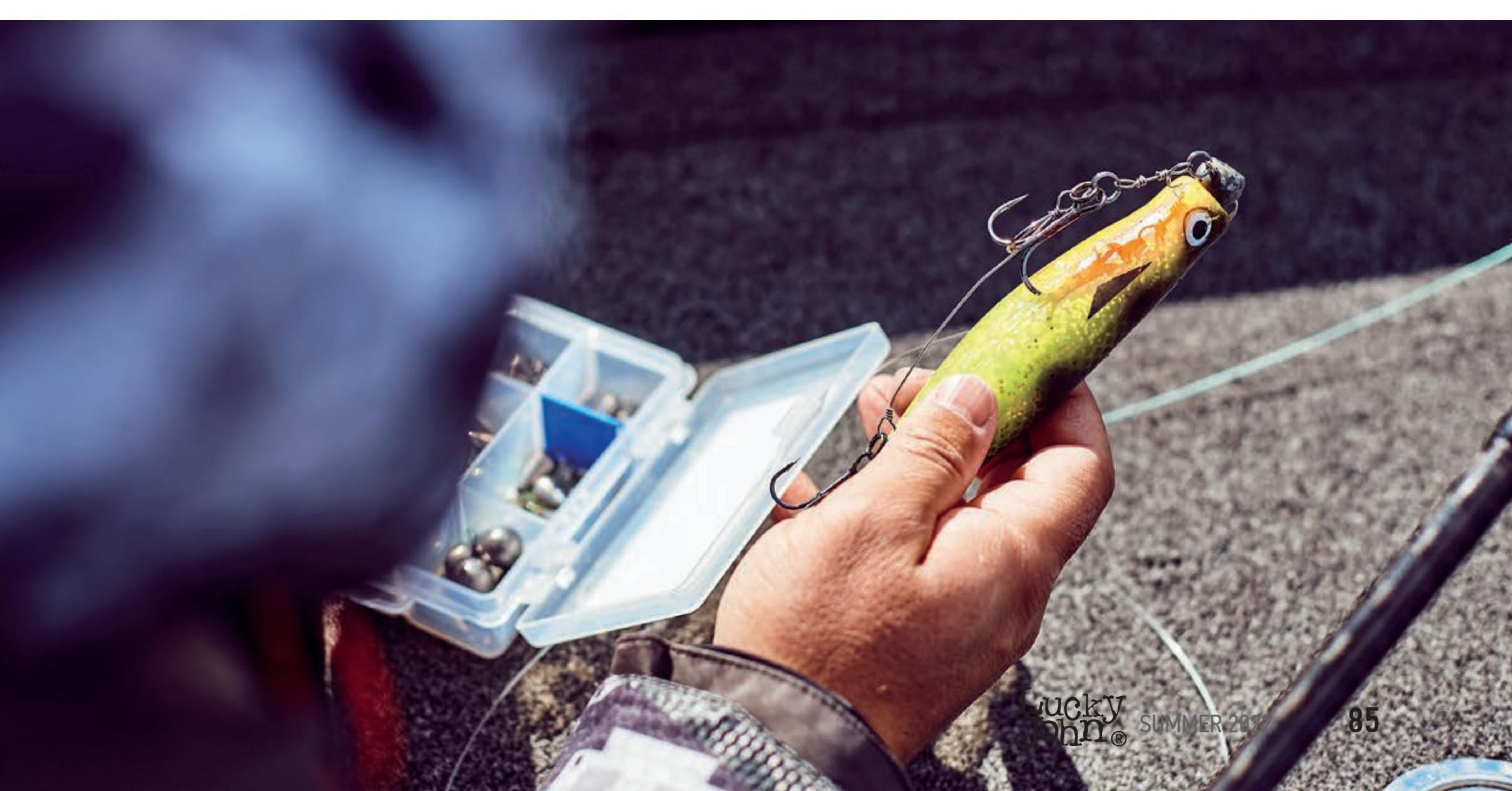

## HIGH-QUALITY HOOKS – LUCKY JOHN

A series of high-quality hooks from LUCKY JOHN for angling of predatory fish is designed for sportsmen and “advanced” anglers. And there is nothing surprising about it – LUCKY JOHN hooks are made only in Japan, in the best specialized factories of the country. In their production, only the highest-quality materials and modern technologies are used. All these factors serve as a guarantee of the highest consistent quality of the hooks. Special technologies, designing, production and testing of the new series of LUCKY JOHN hooks allowed the manufacturer to satisfy all requirements of professional sportsmen regarding the main part of tackle:

- strict technological quality control on every production stage
- special carbon-alloyed steel
- modern heat treatment technologies
- high strength
- finest sharpening of hook point
- durable anti-corrosive coating

## TREBLE HOOKS PREDATOR LJH234

Universal shape treble hook. Used for most types of fishing tackle and various artificial lures.

**Color: NSB.**

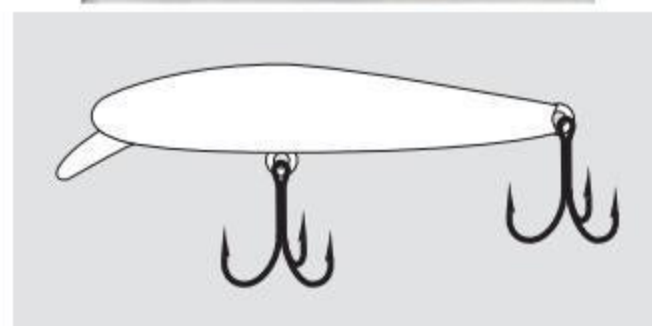

ITEM NO.	SIZE	Q-TY IN PACKAGE (PCS.)
LJH234-001	1	7
LJH234-002	2	7
LJH234-004	4	8
LJH234-006	6	8
LJH234-008	8	8
LJH234-10	10	6
LJH234-K010	1/0	6
LJH234-K020	2/0	5
LJH234-K030	3/0	5

## DOUBLE HOOKS LUCKY JOHN LJH122

Universal shape double hook with a long shank. Used for most types of fishing tackle and various artificial lures.

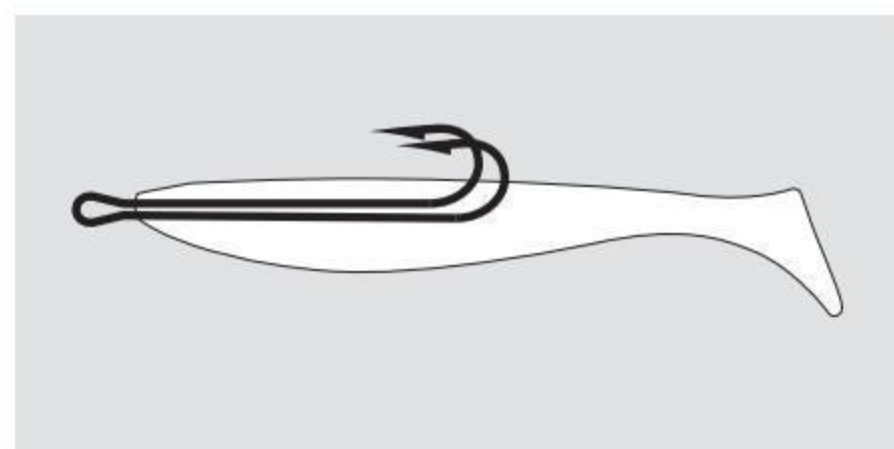

ITEM NO.	SIZE	Q-TY IN PACKAGE (PCS.)
LJH122-K040	4/0	4
LJH122-K030	3/0	4
LJH122-K020	2/0	4
LJH122-K010	1/0	4
LJH122-001	001	5
LJH122-002	002	6
LJH122-004	004	6
LJH122-006	006	6
LJH122-008	008	6
LJH122-010	10	6

## DOUBLE HOOK PREDATOR LJH121

Universal shape double hook. Used for most types of fishing tackle and various artificial lures.

**Color: NSB.**

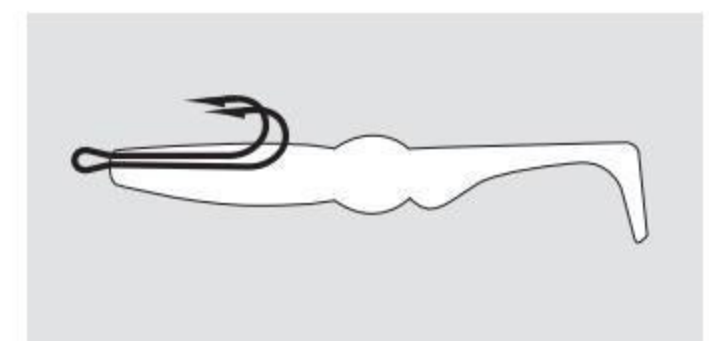

ITEM NO.	SIZE	Q-TY IN PACKAGE (PCS.)
LJH121-001	1	6
LJH121-002	2	6
LJH121-004	4	8
LJH121-006	6	8
LJH121-K010	1/0	6
LJH121-K020	2/0	4
LJH121-K030	3/0	4
LJH121-K040	4/0	4

## TRAILER HOOKS LUCKY JOHN LJH531

Universal hook to replace treble hooks on wobblers, trout fishing spoon-baits and other lures.



Big Eye

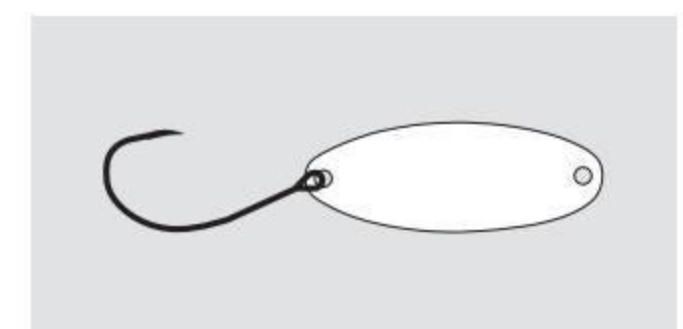

ITEM NO.	SIZE	Q-TY IN PACKAGE (PCS.)
LJH531-006	6	8
LJH531-004	4	7
LJH531-002	2	6
LJH531-001	1	6

## TRAILER HOOKS LUCKY JOHN LJH559

Universal hook to replace treble hooks on wobblers, trout fishing spoon-baits and other lures.



Big Eye



ITEM NO.	SIZE	Q-TY IN PACKAGE (PCS.)
LJH559-010	10	9
LJH559-008	8	8
LJH559-006	6	8
LJH559-004	4	7
LJH559-002	2	6
LJH559-001	1	6



## OFFSET HOOKS LUCKY JOHN LJH345

Universal offset hook. Used for most types of fishing tackle and various artificial lures.

**Color: NSB.**

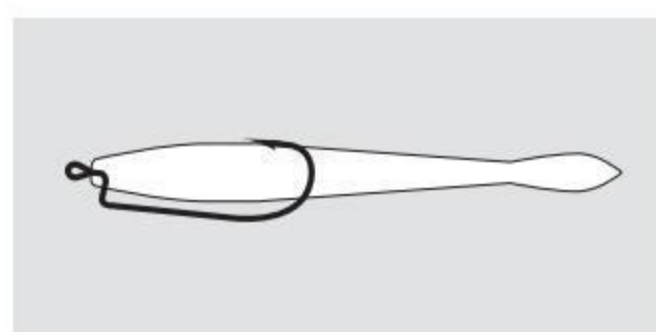

ITEM NO.	SIZE	Q-TY IN PACKAGE (PCS.)
LJH345-004	4	8
LJH345-002	2	8
LJH345-001	1	8
LJH345-K010	1/0	8
LJH345-K020	2/0	7
LJH345-K030	3/0	6
LJH345-K040	4/0	5

## OFFSET HOOKS LUCKY JOHN LJH350

Offset hooks with the broadest bend which is perfect for large soft plastic lures, such as shads, twisters and others. Hooks with classic rectangular step for the fixation of plastic lures and with extremely sharp hook point.

**Color: B**

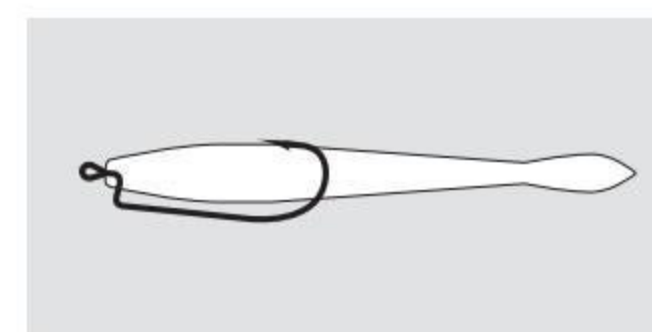

ITEM NO.	SIZE	Q-TY IN PACKAGE (PCS.)
LJH350-001	1	8
LJH350-K010	1/0	8
LJH350-K020	2/0	7
LJH350-K030	3/0	6
LJH350-K040	4/0	5
LJH350-K050	5/0	5

## OFFSET HOOKS PREDATOR LjH355

Offset hooks with round broad bend and classic rectangular step. Large eyelet diameter.

**Color: NSB.**



Big Eye

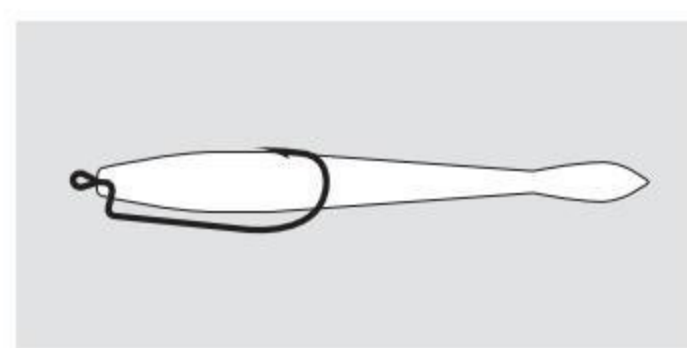

ITEM NO.	SIZE	Q-TY IN PACKAGE (PCS.)
LJH355-001	1	8
LJH355-002	2	8
LJH355-004	4	8
LJH355-006	6	10
LJH355-008	8	10
LJH355-K010	1/0	8
LJH355-K020	2/0	7
LJH355-K030	3/0	6
LJH355-K050	5/0	5

## DROP SHOT HOOKS LUCKY JOHN LjH520

Specially designed hooks to avoid unbending serve for drop-shot fishing. High-quality carbon alloyed steel. Electrochemical sharpening of the hook point, laser control of the sharpening quality, durable anti-corrosive coating.

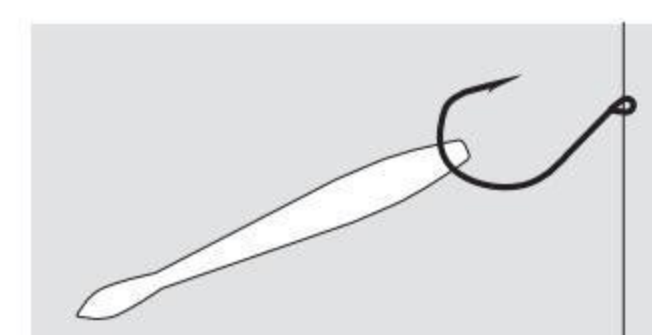

ITEM NO.	SIZE	Q-TY IN PACKAGE (PCS.)
LJH520-006	6	8
LJH520-004	4	7
LJH520-002	2	6
LJH520-001	1	6
LJH520-K010	1/0	6

## HOOKS PREDATOR LjH532

Universal hooks to replace treble hooks on wobblers, trout spoon-baits and other lures.



Big Eye

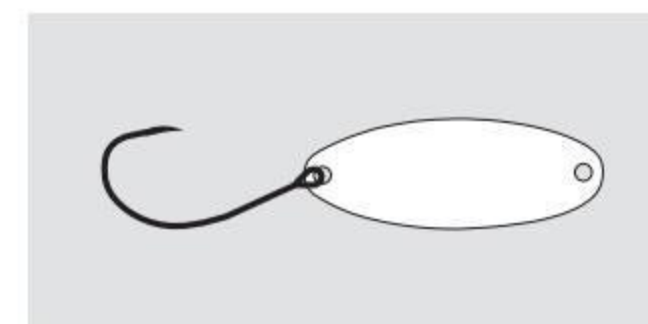

ITEM NO.	SIZE	Q-TY IN PACKAGE (PCS.)
<b>NEW</b> LJH532-002	2	6
LJH532-004	4	6
LJH532-006	6	6
<b>NEW</b> LJH532-008	8	6

## LUCKY JOHN SWIWELS AND SNAPS

### CROSSLOCK

Snap for use in various fishing systems.

ITEM NO.	TEST (KG)	Q-TY IN PACKAGE (PCS.)
LJP5110-001	13,5	10
LJP5110-0015	17,1	10
LJP5110-002	27	7
LJP5110-003	31,5	7

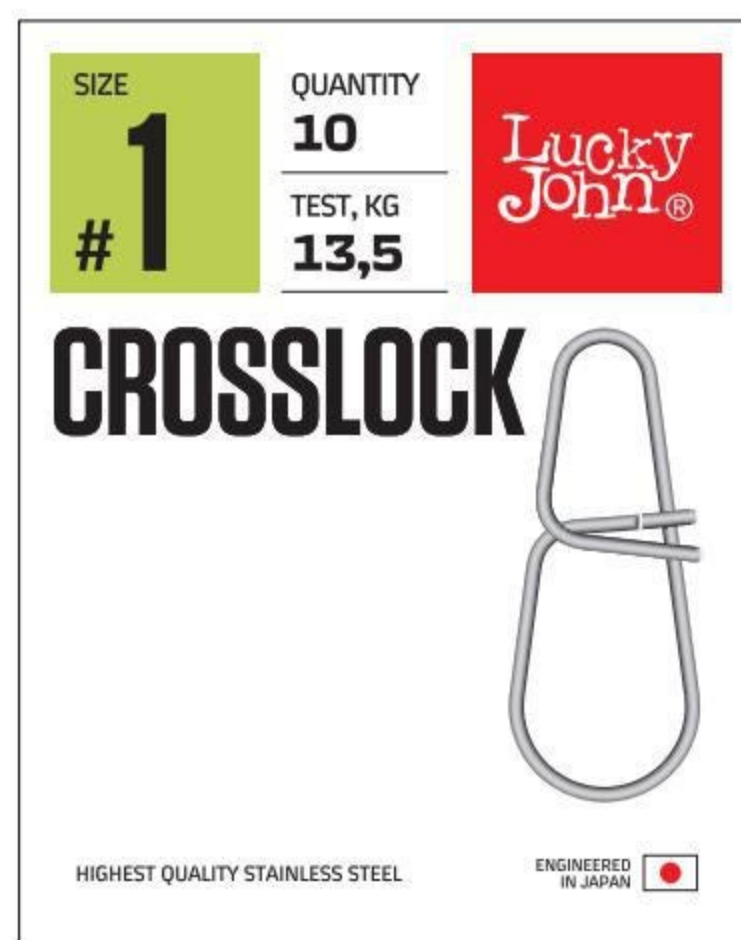

### FASTLOCK SNAP

Snap for use in various fishing systems.

ITEM NO.	TEST (KG)	Q-TY IN PACKAGE (PCS.)
LJP5111-0000	4	10
LJP5111-000	9	10
LJP5111-001	18	10
LJP5111-002	22	10
LJP5111-003	27	9
LJP5111-004	35	8
LJP5111-005	40	7

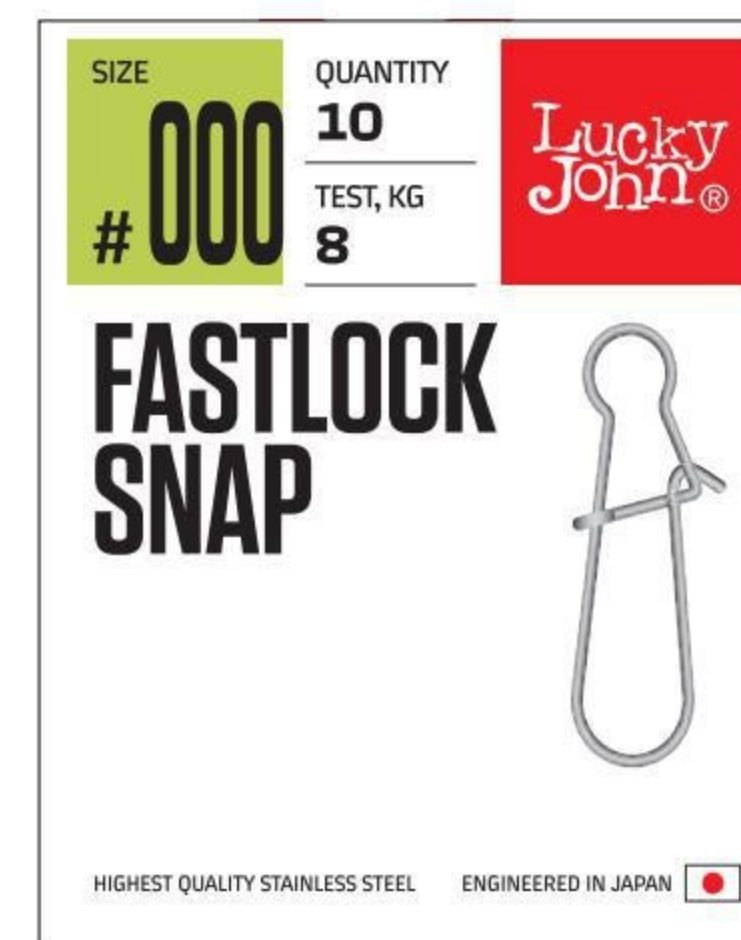

### SPIRAL SNAP

Snap for use in various fishing systems.

ITEM NO.	TEST (KG)	Q-TY IN PACKAGE (PCS.)
LJP5114-000	4	7
LJP5114-001	7	7
LJP5114-002	9	6



### V-SNAP

Snap for use in various fishing systems.

ITEM NO.	TEST (KG)	Q-TY IN PACKAGE (PCS.)
LJP5115-000	6	10
LJP5115-001	10	10
LJP5115-002	15	10
LJP5115-003	18	10

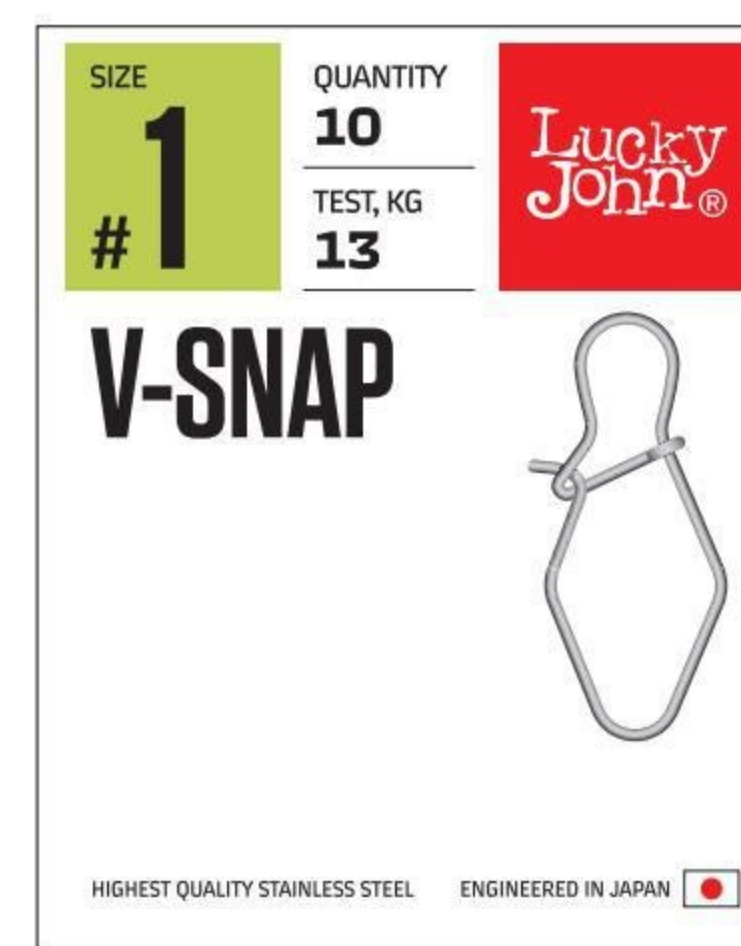

### ROUND SNAP

Snap for use in various fishing systems.

ITEM NO.	TEST (KG)	Q-TY IN PACKAGE (PCS.)
LJP5113-0000	3	10
LJP5113-000	5,8	10
LJP5113-001	9	10
LJP5113-002	10,8	10
LJP5113-003	12	10

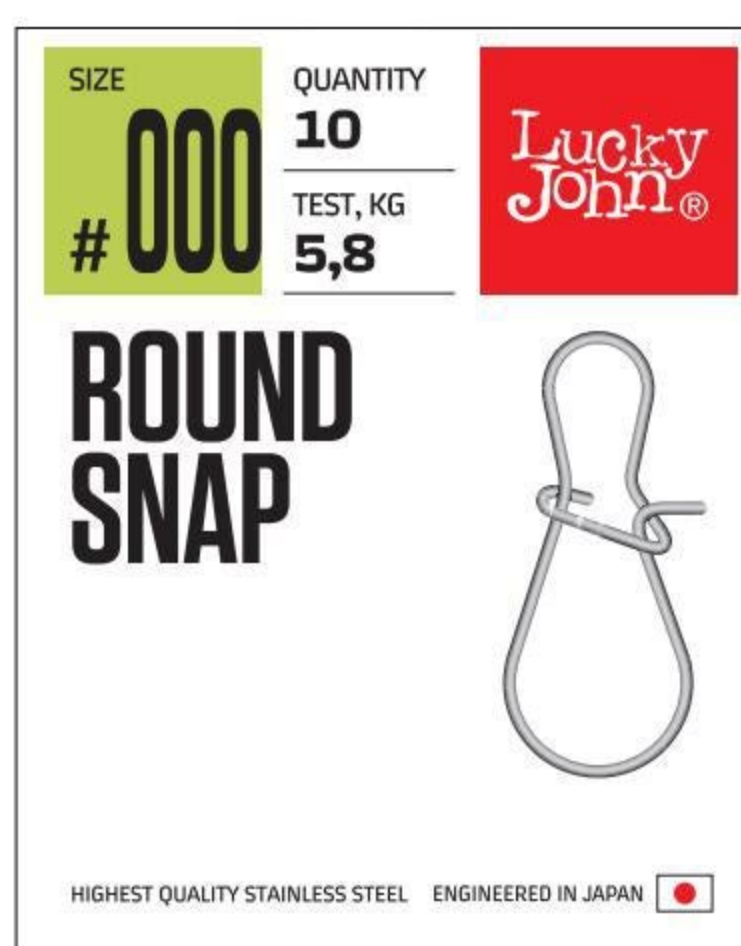

### WRAPPING

Snap for use in various fishing systems.

ITEM NO.	TEST (KG)	Q-TY IN PACKAGE (PCS.)
LJP5112-01SS	2	8
LJP5112-02S	4	8
LJP5112-03M	8	7
LJP5112-04L	9	7



### DROP SNAP

Snap for use in various fishing systems.

ITEM NO.	TEST (KG)	Q-TY IN PACKAGE (PCS.)
LJP5125-0000	4	8
LJP5125-000	6	8
LJP5125-001	9	8
LJP5125-002	12	8
LJP5125-003	18	8

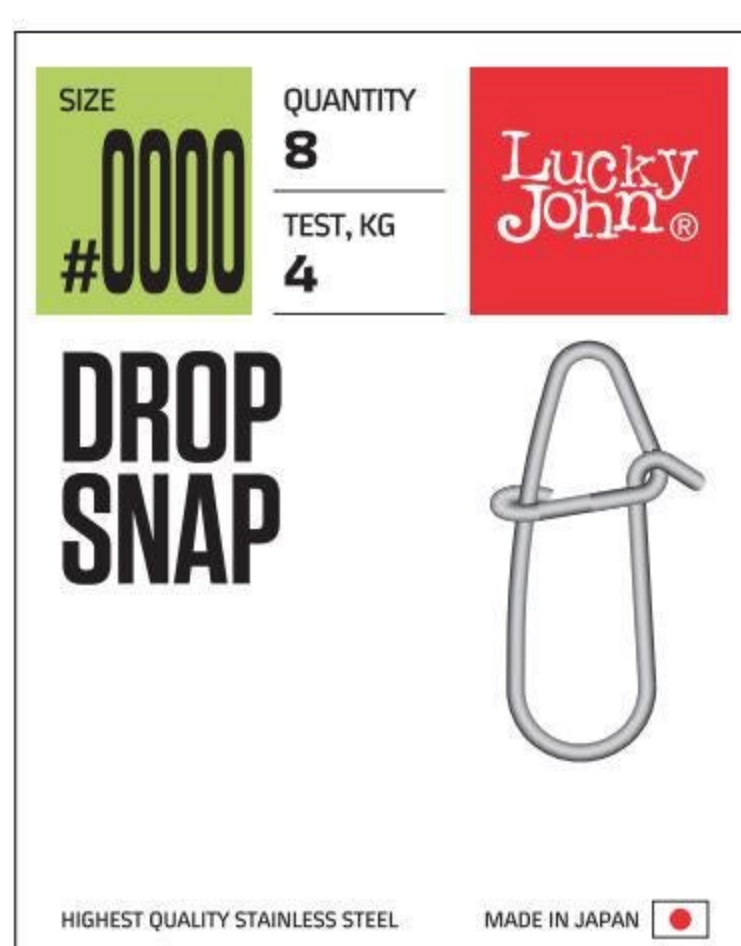

### POWER LURE SNAP

Snap for use in various fishing systems.

ITEM NO.	TEST (KG)	Q-TY IN PACKAGE (PCS.)
LJP5126-001	28	8
LJP5126-002	32	7
LJP5126-003	35	6
LJP5126-004	60	5

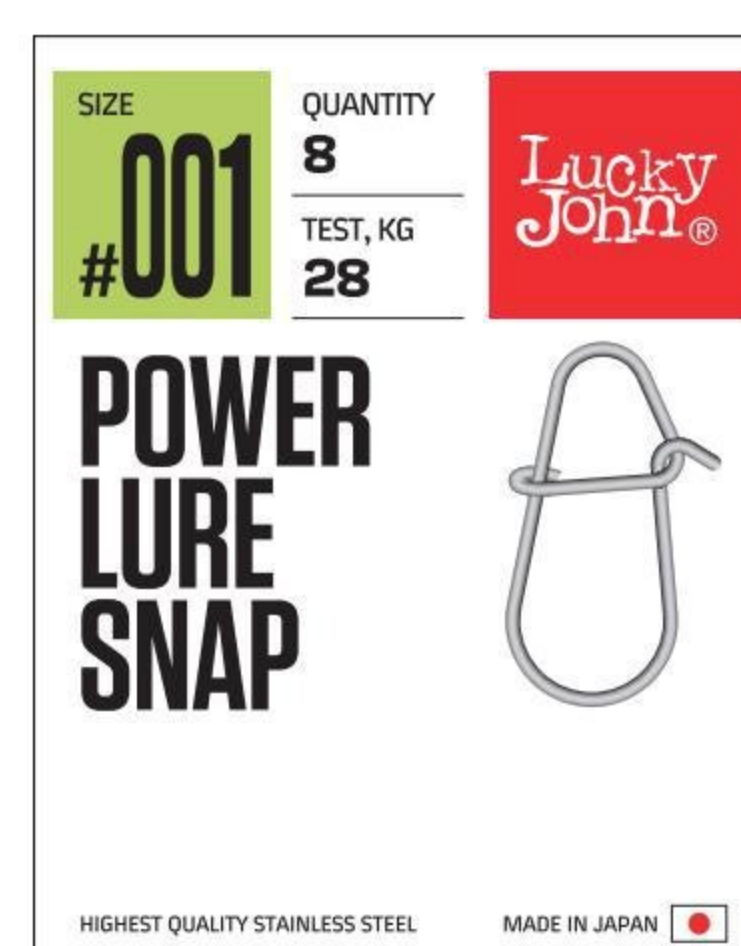

## OVAL RING RIG

ITEM NO.	TEST (KG)	Q-TY IN PACKAGE (PCS.)
LJP5129-001	11	10
LJP5129-002	15	10

SIZE #001 QUANTITY 10 TEST, KG 11

**Lucky John®**

**OVAL RING RIG**



HIGHEST QUALITY STAINLESS STEEL MADE IN JAPAN

## SOLID RINGS

ITEM NO.	TEST (KG)	Q-TY IN PACKAGE (PCS.)
LJP5130-000	6	10
LJP5130-0000	4	10
LJP5130-001	8	10
LJP5130-002	10	10
LJP5130-003	12	10

SIZE #3 QUANTITY 10 TEST, KG 6

**Lucky John®**

**SOLID RINGS**



HIGHEST QUALITY STAINLESS STEEL MADE IN JAPAN

## SPLIT RINGS

Split rings for use in various fishing systems.

ITEM NO.	TEST (KG)	Q-TY IN PACKAGE (PCS.)
LJP5117-0000	2	10
LJP5117-000	3	10
LJP5117-001	4	10
LJP5117-002	5	10
LJP5117-003	6	10
LJP5117-004	7	7
LJP5117-005	8	7
LJP5117-006	10	5

SIZE #000 QUANTITY 10 TEST, KG 2

**Lucky John®**

**SPLIT RINGS**



HIGHEST QUALITY STAINLESS STEEL ENGINEERED IN JAPAN

## DOUBLE INSURANCE INSIDE LOCK SNAP

ITEM NO.	SIZE	STRENGTH (KG)	Q-TY IN PACKAGE (PCS.)
LJP5128-002	6	85	5
LJP5128-003	5	70	6
LJP5128-004	4	55	6
LJP5128-005	3	40	7
LJP5128-006	2	28	7

SIZE #002 QUANTITY 5 TEST, KG 85

**Lucky John®**

**DOUBLE INSURANCE INSIDE LOCK SNAP**



HIGHEST QUALITY STAINLESS STEEL MADE IN JAPAN

## BRASS TUBE

Brass tube fishing accessory.

ITEM NO.	DIAMETER (MM)	Q-TY IN PACKAGE (PCS.)
LJP5123-006	0,6	20
LJP5123-008	0,8	20
LJP5123-010	1,0	20
LJP5123-012	1,2	20
LJP5123-014	1,4	20
LJP5123-016	1,6	20
LJP5123-018	1,8	20
LJP5123-020	2,0	20

SIZE (MM) 0.6 QUANTITY 20

**Lucky John®**

**BRASS TUBE**



HIGHEST QUALITY STAINLESS STEEL MADE IN JAPAN

## CHAIN SNAP

Snap for use in various fishing systems.

ITEM NO.	TEST (KG)	Q-TY IN PACKAGE (PCS.)
LJP5127-S	3	9
LJP5127-M	4	8
LJP5127-L	5	7

SIZE #S QUANTITY 9 TEST, KG 3

**Lucky John®**

**CHAIN SNAP**



HIGHEST QUALITY STAINLESS STEEL MADE IN JAPAN

## LJ CORCKSCROW KIT

Fishing accessory. Corkscrews for all sizes soft lures.

ITEM NO.	QTY IN PACKAGE (PCS.)
LJP5120-SS	8
LJP5120-S	8
LJP5120-M	7
LJP5120-L	7
LJP5120-XL	6

SIZE #SS QUANTITY 8

**Lucky John®**

**CORK-SCROW KIT**



HIGHEST QUALITY STAINLESS STEEL MADE IN JAPAN

## LJ SPIKE KIT

Fishing accessory. Spikes that will allow to fit the stingers perfect to the soft lures.

ITEM NO.	QTY IN PACKAGE (PCS.)
LJP5121-S	10
LJP5121-M	10
LJP5121-L	10

SIZE #S QUANTITY 10

**Lucky John®**

**SPIKE KIT**



HIGHEST QUALITY STAINLESS STEEL MADE IN JAPAN

## ROULETTE BODYROLLING

ITEM NO.	TEST (KG)	Q-TY IN PACKAGE (PCS.)
LJP5107-000	60	5
LJP5107-001	47	6
LJP5107-002	43	7
LJP5107-004	35	8
LJP5107-006	27	10
LJP5107-008	19	10
LJP5107-010	14	10

SIZE  
**#1/0**

QUANTITY  
**5**

TEST, KG  
**60**



### ROULETTE BODYROLLING



HIGHEST QUALITY STAINLESS STEEL    ENGINEERED IN JAPAN 

## BARREL

ITEM NO.	TEST (KG)	Q-TY IN PACKAGE (PCS.)
LJP5106-007	20	7
LJP5106-010	16	7
LJP5106-012	14	10
LJP5106-014	10	10
LJP5106-016	8	10

SIZE  
**#7**

QUANTITY  
**7**

TEST, KG  
**20**



### BARREL



HIGHEST QUALITY STAINLESS STEEL    ENGINEERED IN JAPAN 

## DOUBLE COLOR ROLLING SWIVELS

ITEM NO.	TEST (KG)	Q-TY IN PACKAGE (PCS.)
LJP5121-006	27	10
LJP5121-008	19	10
LJP5121-010	14	10
LJP5121-012	9	10
LJP5121-014	4	10

SIZE #  
**6**

QUANTITY  
**10**

TEST, KG  
**27**



### DOUBLE COLOR ROLLING SWIVELS



HIGHEST QUALITY STAINLESS STEEL    MADE IN JAPAN 

## CROSSLINE

ITEM NO.	TEST (KG)	Q-TY IN PACKAGE (PCS.)
LJP5109-007	17	7
LJP5109-010	15	7
LJP5109-012	12	10
LJP5109-014	9	10
LJP5109-016	8	10

SIZE  
**#7**

QUANTITY  
**7**

TEST, KG  
**17**



### CROSSLINE



HIGHEST QUALITY STAINLESS STEEL    ENGINEERED IN JAPAN 

## CROSSLINE SWIVEL

Three-way crossline swivel for use in various fishing systems.

ITEM NO.	TEST (KG)	Q-TY IN PACKAGE (PCS.)
LJP5108-004	28	6
LJP5108-006	21	7
LJP5108-008	17	10
LJP5108-010	15	10
LJP5108-012	12	10

SIZE  
**#4**

QUANTITY  
**7**

TEST, KG  
**28**



### CROSSLINE SWIVEL



HIGHEST QUALITY STAINLESS STEEL    ENGINEERED IN JAPAN 

## BARREL AND INTERLOCK

Swivel with snap for use in various fishing systems.

ITEM NO.	TEST (KG)	Q-TY IN PACKAGE (PCS.)
LJP5103-007	18	7
LJP5103-010	14	7
LJP5103-012	12	7
LJP5103-014	10	10
LJP5103-016	8	10

SIZE  
**#7**

QUANTITY  
**7**

TEST, KG  
**20**



### BARREL AND INTERLOCK



HIGHEST QUALITY STAINLESS STEEL    ENGINEERED IN JAPAN 

## BALL BEARING SWIVEL

Swivel with snap for use in various fishing systems.

ITEM NO.	TEST (KG)	Q-TY IN PACKAGE (PCS.)
LJP5102-000	12	3
LJP5102-001	18	3
LJP5102-002	22	3
LJP5102-003	25	3

SIZE  
**#0**

QUANTITY  
**3**

TEST, KG  
**12**



### BALL BEARING SWIVEL



HIGHEST QUALITY STAINLESS STEEL    ENGINEERED IN JAPAN 

## ROLLING SWIVEL FASTLOCK

Swivel with snap for use in various fishing systems.

ITEM NO.	TEST (KG)	Q-TY IN PACKAGE (PCS.)
LJP5101-002	38	7
LJP5101-004	32	7
LJP5101-006	25	10
LJP5101-008	18	10
LJP5101-010	14	10
LJP5101-012	9	10
LJP5101-014	4	10

SIZE  
**#2**

QUANTITY  
**7**

TEST, KG  
**38**



### ROLLING SWIVEL FASTLOCK



HIGHEST QUALITY STAINLESS STEEL    ENGINEERED IN JAPAN 



## LUCKY JOHN LEADERS

### LEADER SSW AFW

SSW AFW leaders – light steel fibres twisted in a 7x7 braided leader. This makes them especially soft and reduces deformation during the fishing. The leaders are equipped with high quality swivels (for connecting to the main fishing line) and swivels with snaps (for attaching the bait). Having two swivels significantly reduces the twisting of the fishing line.

- alloy steel
- high strength
- deformation resistant
- corrosion-proof

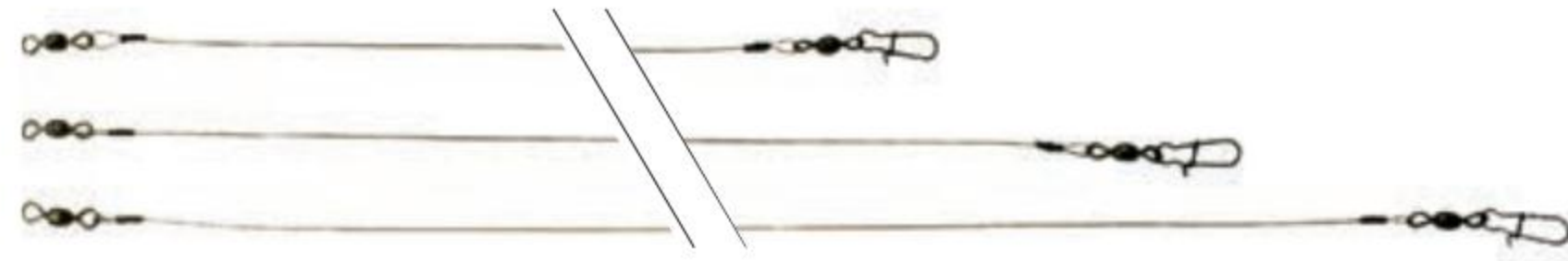
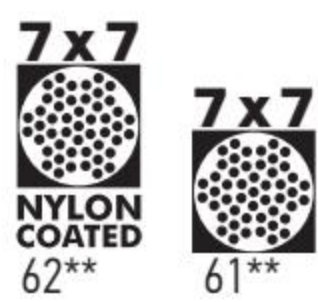

ITEM NO.	MATERIAL	TEST (KG)	LENGTH (CM)	DIAMETER (MM)	QTY IN PACKAGE (PCS.)
LJP6109-015	alloy steel	9	15	0,28	2
LJP6109-020	alloy steel	9	20	0,28	2
LJP6109-025	alloy steel	9	25	0,28	2
LJP6109-030	alloy steel	9	30	0,28	2
LJP6112-015	alloy steel	12	15	0,36	2
LJP6112-020	alloy steel	12	20	0,36	2
LJP6112-025	alloy steel	12	25	0,36	2
LJP6112-030	alloy steel	12	30	0,36	2
LJP6112-035	alloy steel	12	35	0,36	2
LJP6120-015	alloy steel	20	15	0,44	2
LJP6120-020	alloy steel	20	20	0,44	2
LJP6120-025	alloy steel	20	25	0,44	2
LJP6120-030	alloy steel	20	30	0,44	2
LJP6120-035	alloy steel	20	35	0,44	2

ITEM NO.	MATERIAL	TEST (KG)	LENGTH (CM)	DIAMETER (MM)	QTY IN PACKAGE (PCS.)
LJP6209-015	alloy steel	9	15	0,28	2
LJP6209-020	alloy steel	9	20	0,28	2
LJP6209-025	alloy steel	9	25	0,28	2
LJP6209-030	alloy steel	9	30	0,28	2
LJP6212-015	alloy steel	12	15	0,36	2
LJP6212-020	alloy steel	12	20	0,36	2
LJP6212-025	alloy steel	12	25	0,36	2
LJP6212-030	alloy steel	12	30	0,36	2
LJP6212-035	alloy steel	12	35	0,36	2
LJP6220-015	alloy steel	20	15	0,44	2
LJP6220-020	alloy steel	20	20	0,44	2
LJP6220-025	alloy steel	20	25	0,44	2
LJP6220-030	alloy steel	20	30	0,44	2
LJP6220-035	alloy steel	20	35	0,44	2

### LEADER FLUOROCARBON BIGBAIT

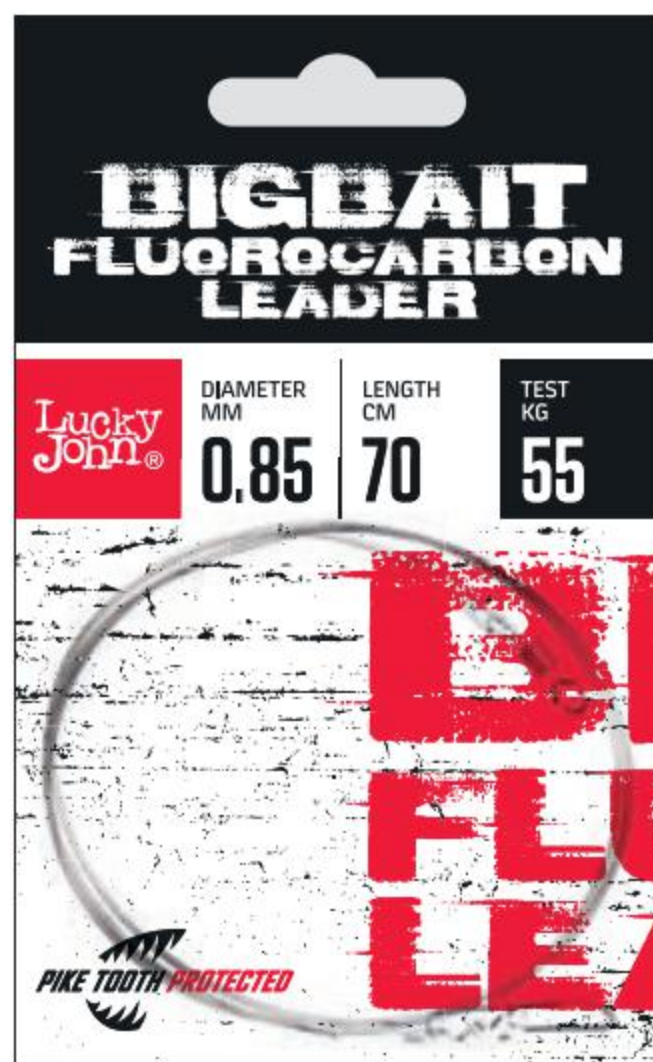

ITEM NO.	MATERIAL	TEST (KG)	LENGTH (CM)	DIAMETER (MM)	PCS/PACK
LJP6355-070	Fluorocarbon	55	70	0,85	1
LJP6370-080	Fluorocarbon	70	80	1,05	1



## STAINLESS STEEL WIRE LEADER SSW **NEW**



SSW leaders made of 7 light steel braided fibres coated with a specifically impregnated synthetic thread. Reliable for pike fishing.

DIAMETER, MM **0.45** QUANTITY **2**  
LENGTH, CM **15** TEST, KG **6**

**Original**

**STAINLESS STEEL WIRE LEADER**

**1X7 NYLON COATED**

HIGHEST QUALITY STAINLESS STEEL

- ▶ green matte coating
- ▶ deformation resistant
- ▶ corrosion-proof
- ▶ high strength

ITEM NO.	MATERIAL	TEST (KG)	LENGTH (CM)	DIAMETER (MM)	Q-TY IN PACKAGE (PCS.)
LJ7071-150	alloy steel	6	15	0,45	2
LJ7071-250	alloy steel	6	25	0,45	2
LJ7071-300	alloy steel	6	30	0,45	2
LJ7071-350	alloy steel	6	35	0,45	2
LJ7072-150	alloy steel	9	15	0,48	2
LJ7072-250	alloy steel	9	25	0,48	2
LJ7072-300	alloy steel	9	30	0,48	2
LJ7072-350	alloy steel	9	35	0,48	2
LJ7073-150	alloy steel	12	15	0,52	2
LJ7073-250	alloy steel	12	25	0,52	2
LJ7073-300	alloy steel	12	30	0,52	2
LJ7073-350	alloy steel	12	35	0,52	2

## STAINLESS STEEL WIRE LEADER SSW **NEW** 7X7



SSW 7X7 leaders – made of 49 alloy steel braided microfibres. Soft and elastic – the same as monofilament fishing line of the same diameter. Color – dark. Snap – Crosslock.

DIAMETER, MM **0.45** QUANTITY **2**  
LENGTH, CM **15** TEST, KG **6**

**Original**

**STAINLESS STEEL WIRE LEADER**

**7X7 NYLON COATED**

HIGHEST QUALITY STAINLESS STEEL

- ▶ black matte coating
- ▶ deformation resistant
- ▶ corrosion-proof
- ▶ high strength

ITEM NO.	MATERIAL	TEST (KG)	LENGTH (CM)	DIAMETER (MM)	Q-TY IN PACKAGE (PCS.)
LJ7083-150	alloy steel	9	15	0,50	2
LJ7083-250	alloy steel	9	25	0,50	2
LJ7083-300	alloy steel	9	30	0,50	2
LJ7083-350	alloy steel	9	35	0,50	2
LJ7084-150	alloy steel	12	15	0,55	2
LJ7084-250	alloy steel	12	25	0,55	2
LJ7084-300	alloy steel	12	30	0,55	2
LJ7084-350	alloy steel	12	35	0,55	2
LJ7085-150	alloy steel	18	15	0,60	2
LJ7085-250	alloy steel	18	25	0,60	2
LJ7085-300	alloy steel	18	30	0,60	2
LJ7085-350	alloy steel	18	35	0,60	2
LJ7086-150	alloy steel	6	15	0,45	2
LJ7086-250	alloy steel	6	25	0,45	2
LJ7086-300	alloy steel	6	30	0,45	2
LJ7086-350	alloy steel	6	35	0,45	2

## STAINLESS STEEL WIRE LEADER COMBO SSW 7X7 **NEW**



ITEM NO.	MATERIAL	TEST (KG)	LENGTH (CM)	DIAMETER (MM)	Q-TY IN PACKAGE (PCS.)
LJ7074-015	alloy steel	6	15	0,45	20
LJ7074-025	alloy steel	6	25	0,45	20
LJ7074-035	alloy steel	6	35	0,45	20
LJ7075-015	alloy steel	9	15	0,48	20
LJ7075-025	alloy steel	9	25	0,48	20
LJ7075-035	alloy steel	9	35	0,48	20
LJ7076-015	alloy steel	12	15	0,52	20
LJ7076-025	alloy steel	12	25	0,52	20
LJ7076-035	alloy steel	12	35	0,52	20

DIAMETER, MM **0.45** QUANTITY **20**  
LENGTH, CM **15** TEST, KG **6**

**Original**

**STAINLESS STEEL WIRE LEADER COMBO**

HIGHEST QUALITY STAINLESS STEEL

## LUCKY JOHN EVA BOAT BAG SET WITH 2 BOXES

Durable waterproof lure bag  
 Main compartment have 2 plastic boxes  
 Top compartment for fishing accessories storage  
 Top compartment is detachable and can be used as separate bag  
 Boxes included: 2 pcs 38 x 22,5 x 4,8 cm



ITEM NO.  
LJ3825-019EBBD

SIZE (CM)  
38 x 25 x 19

## LUCKY JOHN EVA BOAT BAG SET WITH 4 BOXES

Durable waterproof lure bag  
 Main compartment have 4 plastic boxes  
 Top compartment for fishing accessories storage  
 Top compartment is detachable and can be used as separate bag  
 Boxes included: 4 pcs 38 x 22,5 x 4,8 cm



ITEM NO.  
LJ3825-030EBBD

SIZE (CM)  
38 x 25 x 30

## LUCKY JOHN EVA BOAT BAG SET WITH TRAY AND 1 BOX

Durable waterproof lure bag  
 Main compartment have 1 plastic box  
 On top of the box is tray for keeping ready lures or small accessories  
 Box included: 1 pc 38 x 22,5 x 8 cm



ITEM NO.  
LJ4025-014EBBT

SIZE (CM)  
40 x 22,5 x 14



## LUCKY JOHN EVA BOAT BAG LARGE

Durable waterproof boat bag  
Clip on the top, so you can open only half of the bag  
Adjustable shoulder strap



ITEM NO.

LJ4030-025EBAL

SIZE (CM)

40 x 30 x 25

## LUCKY JOHN EVA BOAT BAG UNIVERSAL

Waterproof boat bag with rod holders.

- Waterproof
- Adjustable straps and handles
- One large compartment for fishing gear or caught fish
- Easy to clean bag and compartment
- Double zipped soft cover
- Clip on the cover top for half opening the bag
- Rod holders on the sides
- Additional tackle holders on the sides
- 2 Plastic handles, can be fastened together
- Main compartment size (cm) – 36 x 23 x 24
- Material – EVA, 600D Polyester
- Weight (kg) – 1,21



ITEM NO.

LJ101B

SIZE (CM)

36 x 23 x 25

## LUCKY JOHN EVA ACCESSORY BAGS

Universal fishing accessory bags.

- Waterproof
- Easy to clean
- Transparent lid
- Size (cm) – 27 x 17 x 10
- Material – EVA



ITEM NO.

LJ102B

LJ103B

LJ104B

SIZE (CM)

21 x 14,5 x 8

24 x 15,5 x 9

27 x 17 x 10

## LUCKY JOHN RUCKSACK

One of the best options for angler-walker. All compartments and pockets have zippers. Everything with you but hands are free!

- Upper and lower compartments separated by a detachable partition
- In the lower compartment 3 boxes included - 275 x 185 x 45 mm
- Large upper compartment – for fishing reels or other items
- Two inside «secret» pockets, across the entire height of the backpack
- In the upper opening side - a transparent plastic pocket
- Two spacious side pockets
- Two holders for spinning rods and landing net
- Adjustable straps on the top
- Padded back and shoulder straps
- Handle
- Waterproof bottom
- Size (cm) - 40 x 38 x 23
- Material - 600D Polyester
- Weight (kg) – 1,93



ITEM NO.  
LJ121B

SIZE (CM)  
40 x 38 x 23

## LUCKY JOHN LURE BAG L WITH 6 BOXES

Large fishing bag for lures and fishing accessories with 6 Lucky John boxes.

- Main and upper compartments have double zippers
- Two side pockets with Velcro straps
- Big mesh pocket on the back side
- Upper compartment with a removable soft partition
- Transparent pockets with Velcro straps on the side and on the upper cover
- 3 boxes of size 360 x 230 x 50 mm and one box of size 360 x 230 x 80 mm included in the main compartment
- Two boxes of size 210 x 140 x 40 mm included in the side pockets
- Detachable adjustable strap
- Two soft handles
- Waterproof bottom
- Size (cm) - 25 x 34 x 46
- Material - 600D Polyester
- Weight (kg) – 3,29



ITEM NO.  
LJ112B

SIZE (CM)  
25 x 34 x 46

## LUCKY JOHN LURE BAG S

Fishing bag with Lucky John boxes. Bag for fishing lures with adjustable, padded shoulder strap and handles. Waterproof bottom. It has a large internal compartment with removable partition and three pockets on the sides. All pockets and the cover have zippers.

- 3 plastic boxes (27,5 x 18,5 x 4,5 cm) for large lures with partitions
- 3 zip lock plastic bags (25,0 x 15,0 cm) for soft lures
- Plastic pocket with Velcro straps under the lid
- Adjustable straps on the top to place rain jackets or other clothes
- Large front pocket
- Two side pockets
- Holder for additional spinning rod or landing net
- Plastic ring for attaching fishing accessories
- Size (cm) – 20 x 40 x 27
- Material – 600D Polyester
- Weight (kg) – 1,56



ITEM NO.  
LJ111B

SIZE (CM)  
20 x 40 x 27

## LUCKY JOHN SLING BAG

- Box (27,5 x 18,5 x 4,5 cm) with removable partitions
- Zipped transparent plastic pocket on the side
- 5 zip lock plastic bags (25,0 x 16,0 cm) for soft lures
- Fastener for drinking water bottle on the belt
- Holder for additional spinning rod or landing net
- Plastic ring for attaching fishing accessories
- Adjustable and fixing waist and shoulder belts
- 3 soft paddings where the bag touches the angler's body
- Size (cm) – 20 x 31 x 15
- Material - 600D polyester
- Weight (kg) – 1,04



ITEM NO.	SIZE (CM)
LJ125B	20 x 31 x 15

## LUCKY JOHN LURE WALLETS

### AREA TROUT GAME

Functional lure wallets for trout spoon baits.

- «Book» shape
- Additional inserts
- Transparent PVC dividers
- Quality, resistant material
- Equipped with zippers
- Size (cm) – 18 x 11



ITEM NO.	SIZE (CM)
LJAT-8004	18 x 11

## LUCKY JOHN WAIST BAG



ITEM NO.	SIZE (CM)
LJ130B	30 x 16 x 10

## LUCKY JOHN CARABINER LURE BAG



ITEM NO.	SIZE (CM)
LJ141B	20 x 14 x 5

## LUCKY JOHN LURE WALLET



ITEM NO.	SIZE (CM)
LJ142B	14 x 12,5 x 2

## LUCKY JOHN REEL BAG



ITEM NO.	SIZE (CM)
LJ150B	26,5 x 19 x 10

## LUCKY JOHN BAG FOR SAFE WEIGHING OF TROPHY FISH

**NEW**



ITEM NO.  
LJBBS81-049FWB

SIZE (MM)  
810 x 490

## LUCKY JOHN REEL BAG

**NEW**

Soft reel bag that helps to keep the reels safe during transportation.  
Capacity – 4 reels  
Soft, removable separators  
Zipper  
Handle  
Size – 360 x 260 x 140 mm



ITEM NO.  
LJP3626-014RB

SIZE  
360 x 260 x 140 mm





# FEEDER CONCEPT



# FEEDER CONCEPT

## SPINNING REEL FEEDER CONCEPT

### SPINNING REEL FEEDER CONCEPT TURNAMENT II 7

**NEW**

High quality, reliable feeder fishing reel, designed and produced with precision.

- Front drag FD
- 6 ball bearings
- 1 roller bearing
- Instant anti-reverse
- Reel body and rotor - high durability plastic
- Main spool - shallow aluminium
- Spare spool - shallow aluminium
- Big line roller extended (anti-twist)

**Handle:**

- Aluminium CNC
- "Screw in" type
- Possibility of right/left placement
- Ergonomic rubber handle knob



--	--	--	--	--	--	--	--	--

ITEM NO.	SIZE	DRAG	BB	SIZE	WEIGHT (G)	GEAR RATIO	SPOOL	SPARE SPOOL
FCT07-50FD	5000	FD	6	1	378	5,0:1	1AL	1AL
FCT07-60FD	6000	FD	6	1	380	5,0:1	1AL	1AL

## SPINNING REEL FEEDER CONCEPT **PILOT 7**

Modern feeder fishing reel specifically designed for fishing rods of the medium-light class.

- Front drag FD
- 6 ball bearings
- 1 roller bearing
- Instant anti-reverse
- Reel body and rotor – high durability plastic
- Main spool – shallow aluminium
- Spare spool – shallow aluminium
- Lightweight, hollow bail arm
- Big line roller extended (anti-twist)

**Handle:**

- "Screw in" type
- Possibility of right/left placement
- Ergonomic handle knob

High quality balancing.



ITEM NO.	SIZE	DRAG	BB	RB	WEIGHT (G)	GEAR RATIO	SPOOL	SPARE SPOOL
FC-1040FD	4000	FD	6	1	295	5,1:1	1Al	1Al
FC-1050FD	5000	FD	6	1	400	5,1:1	1Al	1Al
FC-1060FD	6000	FD	6	1	424	5,1 : 1	1Al	1Al

## SPINNING REEL FEEDER CONCEPT **IMPERIUM 8**

High quality, reliable feeder fishing reel, designed and produced with high precision.

- Front drag FD
- 7 ball bearings
- 1 roller bearing
- Instant anti-reverse
- Reel body and rotor – high durability plastic
- Main spool – shallow aluminum
- Spare spool – shallow aluminum
- Lightweight, hollow bail arm
- Big line roller extended (anti-twist)

**Handle:**

- "Screw in" type
- Possibility of right/left placement
- Ergonomic EVA handle knob



ITEM NO.	SIZE	DRAG	BB	RB	WEIGHT (G)	GEAR RATIO	SPOOL	SPARE SPOOL
FCI08-40FD	4000	FD	7	1	285	5,1 : 1	1Al	1Al
FCI08-50FD	5000	FD	7	1	360	4,7 : 1	1Al	1Al
FCI08-60FD	6000	FD	7	1	390	4,7 : 1	1Al	1Al

# FEEDER CONCEPT

## FEEDER CONCEPT RODS

ITEM NO.	MODEL	BLANK MATERIAL	ACTION	LENGTH (M)	WEIGHT (G)	SECTIONS	TRANSP. LENGTH (CM)
FCDIH150-360	DISTANCE EXTRA HEAVY 150	Carbon fiber	heavy	3,60	270	3 + 3	127
FCDIH180-390	DISTANCE EXTRA HEAVY 180	Carbon fiber	heavy	3,90	340	3 + 3	138
FCDIH210-390	DISTANCE EXTRA HEAVY 210	Carbon fiber	heavy	3,90	360	3 + 3	138
FCSW060-330	SILVER WATER 60	Carbon fiber	medium-fast	3,30	171	3 + 4	115
FCSW070-360	SILVER WATER 70	Carbon fiber	medium-fast	3,60	185	3 + 4	127
FCSW080-375	SILVER WATER 80	Carbon fiber	medium-fast	3,75	210	3 + 4	135
FCDI070-360	DISTANCE 70	Carbon fiber	medium	3,60	232	3 + 3	127
FCDI080-390	DISTANCE 80	Carbon fiber	medium	3,90	267	3 + 3	138
FCDI080-420	DISTANCE 80	Carbon fiber	medium	4,20	289	3 + 3	145
FCDI100-390	DISTANCE 100	Carbon fiber	medium	3,90	300	3 + 3	138
FCDI100-420	DISTANCE 100	Carbon fiber	medium	4,20	321	3 + 3	147
FCDI130-420	DISTANCE 130	Carbon fiber	medium	4,20	330	3 + 3	157
FCDI150-450	DISTANCE 150	Carbon fiber	medium	4,50	361	3 + 3	167
FCPI050-330	PILOT 50	Carbon fiber	medium	3,30	224	3 + 3	115
FCPI070-360	PILOT 70	Carbon fiber	medium	3,60	240	3 + 3	125
FCPI100-390	PILOT 100	Carbon fiber	medium-fast	3,90	282	3 + 3	135
FCPI130-390	PILOT 130	Carbon fiber	medium-fast	3,90	299	3 + 3	135

## FEEDER CONCEPT DISTANCE EXTRA HEAVY

### BLANK:

Material – carbon fiber (36T)

Action – **heavy H**

Joint type – **OVER STEEK**

### HANDLE:

Material Anti slip tube

Screw type reel seat

### TIPS:

Different sensitivity (3 pcs.)

### GUIDES:

Anti-tangle

SIC inserts



ITEM NO.	LENGTH (M)	WEIGHT (G)	CASTING WEIGHT (G)	SECTIONS	TRANSP. LENGTH (CM)	TIPS
FCDIH150-360	3,60	270	80–150	3 + 3	127	1C x 3oz; 1C x 4oz; 1C x 5oz
FCDIH180-390	3,90	340	100–180	3 + 3	138	1C x 3oz; 1C x 4oz; 1C x 5oz
FCDIH210-390	3,90	360	120–210	3 + 3	138	1C x 3oz; 1C x 4oz; 1C x 5oz



## FEDER CONCEPT SILVER WATER 60

### BLANK:

- Material – carbon fiber (40T)
- Action – **medium fast MF**
- Joint type – **OVER STEEK**

### HANDLE:

- Material combined – (hard) **EVA**; AAA grade cork
- Screw type **FUJI** reel seat

### TIPS:

- Different sensitivity (4 pcs.)

### GUIDES:

- Lightweight **PAC BAY**
- High durability



ITEM NO.	LENGTH (M)	WEIGHT (G)	CASTING WEIGHT (G)	SECTIONS	TRANSP. LENGTH (CM)	TIPS
FCSW060-330	3,30	171	60	3 + 4	115	2C x 0,75oz ; 1C x 1,00oz; 1C x 1,5oz

## FEEDER CONCEPT SILVER WATER 70

### BLANK:

- Material – carbon fiber (40T)
- Action – **medium fast MF**
- Joint type – **OVER STEEK**

### HANDLE:

- Material combined – (hard) **EVA**; AAA grade cork
- Screw type **FUJI** reel seat

### TIPS:

- Different sensitivity (4 pcs.)

### GUIDES:

- Lightweight **PAC BAY**
- High durability

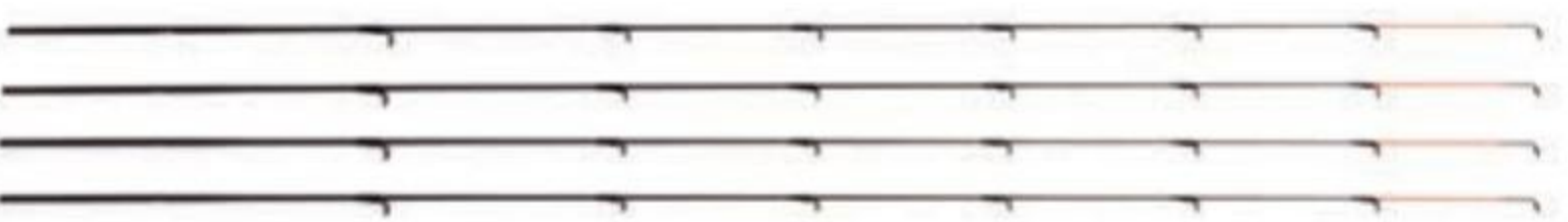

ITEM NO.	LENGTH (M)	WEIGHT (G)	CASTING WEIGHT (G)	SECTIONS	TRANSP. LENGTH (CM)	TIPS
FCSW070-360	3,60	185	70	3 + 4	127	2C x 1,00oz ; 1C x 1,5oz; 1C x 2oz

## FEEDER CONCEPT SILVER WATER 80

### BLANK:

- Material – carbon fiber (40T)
- Action – **medium fast MF**
- Joint type – **OVER STEEK**

### HANDLE:

- Material combined – (hard) **EVA**; AAA grade cork
- Screw type **FUJI** reel seat

### TIPS:

- Different sensitivity (4 pcs.)

### GUIDES:

- Lightweight **PAC BAY**
- High durability

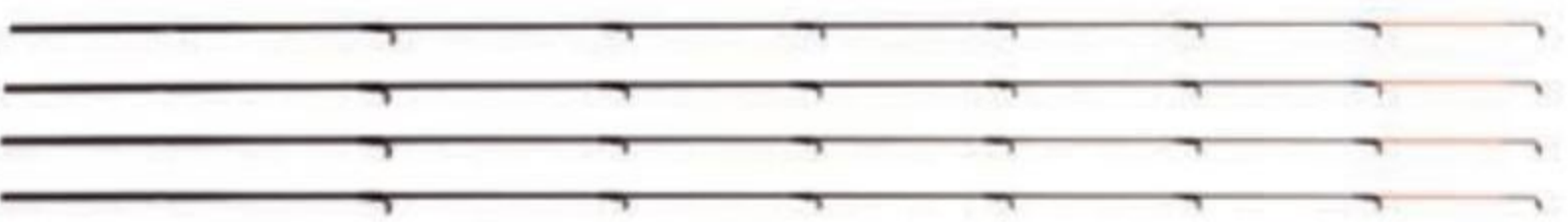

ITEM NO.	LENGTH (M)	WEIGHT (G)	CASTING WEIGHT (G)	SECTIONS	TRANSP. LENGTH (CM)	TIPS
FCSW080-375	3,75	210	80	3 + 4	135	2C x 1,00oz ; 1C x 1,5oz; 1C x 2oz

# FEEDER CONCEPT

## FEEDER CONCEPT SILVER WATER 100

### BLANK:

- Material – carbon fiber (40T)
- Action – **medium fast MF**
- Joint type – **OVER STEEK**

### HANDLE:

- Material combined – (hard) **EVA**; AAA grade cork
- Screw type **FUJI** reel seat

### TIPS:

- Different sensitivity (4 pcs.)

### GUIDES:

- Lightweight **PAC BAY**
- High durability



MF



ITEM NO.	LENGTH (M)	WEIGHT (G)	CASTING WEIGHT (G)	SECTIONS	TRANSP. LENGTH (CM)	TIPS
FCSW100-390	3,90	257	100	3	135	2Cx1,00oz; 1Cx1,5oz; 1Cx2oz

## FEEDER CONCEPT SILVER WATER 120

### BLANK:

- Material – carbon fiber (40T)
- Action – **medium fast MF**
- Joint type – **OVER STEEK**

### HANDLE:

- Material combined – (hard) **EVA**; AAA grade cork
- Screw type **FUJI** reel seat

### TIPS:

- Different sensitivity (4 pcs.)

### GUIDES:

- Lightweight **PAC BAY**
- High durability



MF

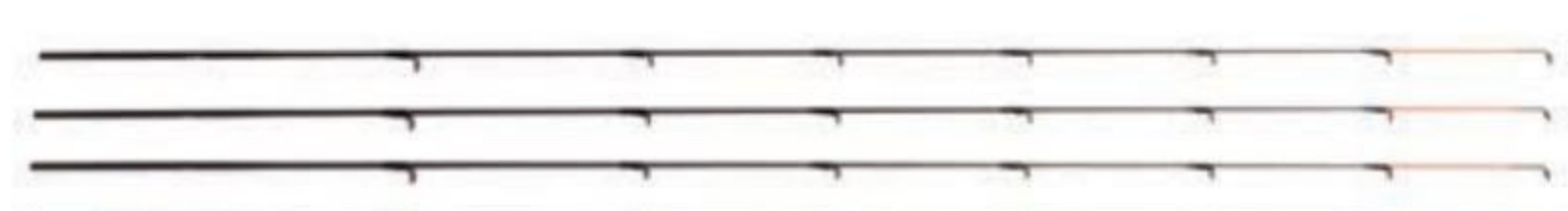

ITEM NO.	LENGTH (M)	WEIGHT (G)	CASTING WEIGHT (G)	SECTIONS	TRANSP. LENGTH (CM)	TIPS
FCSW120-390	3,90	261	120	3	135	2Cx1,00oz; 1Cx1,5oz; 1Cx2oz



## FEEDER CONCEPT DISTANCE RODS

### FEEDER CONCEPT DISTANCE 70

**BLANK:**

- Material – carbon fiber (36T)
- Action – **medium fast MF**
- Joint type – **OVER STEEK**

**HANDLE:**

- Material combined – (hard) **EVA**; AAA grade cork
- Screw type **FUJI** reel seat

**TIPS:**

- Different sensitivity (3 pcs.)

**GUIDES:**

- High durability **SIC** inserts



ITEM NO.	LENGTH (M)	WEIGHT (G)	CASTING WEIGHT (G)	SECTIONS	TRANSP. LENGTH (CM)	TIPS
FCDI070-360	3,60	232	30-70	3 + 3	127	1C X 1oz; 1C x 1,5oz; 1C x 2oz

### FEEDER CONCEPT DISTANCE 80

**BLANK:**

- Material – carbon fiber (36T)
- Action – **medium M**
- Joint type – **OVER STEEK**

**HANDLE:**

- Material combined – (hard) **EVA**; AAA grade cork
- Screw type **FUJI** reel seat

**TIPS:**

- Different sensitivity (3 pcs.)

**GUIDES:**

- High durability **SIC** inserts



ITEM NO.	LENGTH (M)	WEIGHT (G)	CASTING WEIGHT (G)	SECTIONS	TRANSP. LENGTH (CM)	TIPS
FCDI080-390	3,90	267	30-80	3 + 3	138	1C X 1oz; 1C x 1,5oz; 1C x 2oz
FCDI080-420	4,20	289	80	3	145	1Cx1oz; 1Cx1,5oz; 1Cx2oz

### FEEDER CONCEPT DISTANCE 100

**BLANK:**

- Material – carbon fiber (36T)
- Action – **medium M**
- Joint type – **OVER STEEK**

**HANDLE:**

- Material combined – (hard) **EVA**; AAA grade cork
- Screw type **FUJI** reel seat

**TIPS:**

- Different sensitivity (3 pcs.)

**GUIDES:**

- High durability **SIC** inserts



ITEM NO.	LENGTH (M)	WEIGHT (G)	CASTING WEIGHT (G)	SECTIONS	TRANSP. LENGTH (CM)	TIPS
FCDI100-390	3,90	300	40-100	3 + 3	138	1C X 1,5oz; 1C x 2oz; 1C x 2,5oz

# FEEDER CONCEPT

## FEEDER CONCEPT DISTANCE 100

### BLANK:

- Material – carbon fiber (36T)
- Action – **medium M**
- Joint type – **OVER STEEK**

### HANDLE:

- Material combined – (hard) **EVA**; AAA grade cork
- Screw type **FUJI** reel seat

### TIPS:

- Different sensitivity (3 pcs.)

### GUIDES:

- High durability **SIC** inserts



ITEM NO.	LENGTH (M)	WEIGHT (G)	CASTING WEIGHT (G)	SECTIONS	TRANSP. LENGTH (CM)	TIPS
FCDI100-420	4,20	321	50-100	3 + 3	147	1C X 1,5oz; 1C x 2oz; 1C x 2,5oz

## FEEDER CONCEPT DISTANCE 130

### BLANK:

- Material – carbon fiber (36T)
- Action – **medium M**
- Joint type – **OVER STEEK**

### HANDLE:

- Material combined – (hard) **EVA**; AAA grade cork
- Screw type **FUJI** reel seat

### TIPS:

- Different sensitivity (3 pcs.)

### GUIDES:

- High durability **SIC** inserts



ITEM NO.	LENGTH (M)	WEIGHT (G)	CASTING WEIGHT (G)	SECTIONS	TRANSP. LENGTH (CM)	TIPS
FCDI130-420	4,20	330	60-130	3 + 3	157	1C X 2oz; 1C x 2,5oz; 1C x 3oz

## FEEDER CONCEPT DISTANCE 150

### BLANK:

- Material – carbon fiber (36T)
- Action – **medium M**
- Joint type – **OVER STEEK**

### HANDLE:

- Material combined – (hard) **EVA**; AAA grade cork
- Screw type **FUJI** reel seat

### TIPS:

- Different sensitivity (3 pcs.)

### GUIDES:

- High durability **SIC** inserts



ITEM NO.	LENGTH (M)	WEIGHT (G)	CASTING WEIGHT (G)	SECTIONS	TRANSP. LENGTH (CM)	TIPS
FCDI150-450	4,50	361	80-150	3 + 3	157	1C X 3oz; 1C x 4oz; 1C x 5oz

## MONOFILAMENT LINE FEEDER CONCEPT FEEDER&FLAT

Monofilament fishing line specially designed for feeder fishing. Maximum sensitivity and minimal stretch ability. Perfect combination of price and quality. Camo color makes it invisible to fish.



STRENGTH TABLE

Diameter (MM)	0,22	0,25	0,27	0,30
Test (kg)	4,50	5,30	6,10	7,50

ITEM NO.	DIAM. (MM)	LENGTH (M)	COLOUR	Q-TY IN PACKAGE
FC4003-022	0,22	150	camo	ind. pack.
FC4003-025	0,25	150	camo	ind. pack.
FC4003-027	0,27	150	camo	ind. pack.
FC4003-030	0,30	150	camo	ind. pack.

## FEEDER CONCEPT LINE DISTANCE X8 BRAID

A modern 8-strand braided fishing line made of PE fibre. The round cross section of the line in combination with a smooth and "slippery" surface provides a long casting distance of the feeder cage. High braid density and increased durability allow the line to be used in all seasons. Supplied in individual package – 150 m length. Excellent combination of price and quality.

- High sensitivity
- Round cross section
- Durable at the knots
- Maximum casting distance
- All-season usage
- Dark green color



STRENGTH TABLE

Diameter (MM)	0,12	0,14	0,16	0,18
Test (kg)	5,50	6,50	7,90	9,80

ITEM NO.	DIAM. (MM)	LENGTH (M)	COLOUR	Q-TY IN PACKAGE
FC4910-012	0,12	150	Dark Green	ind. pack.
FC4910-014	0,14	150	Dark Green	ind. pack.
FC4910-016	0,16	150	Dark Green	ind. pack.
FC4910-018	0,18	150	Dark Green	ind. pack.

## BRAIDED FISHING LINE FEEDER CONCEPT POWERSINK DARK BROWN

Braided fishing line made of high quality 4 strand PE fibre, specially designed for feeder fishing. Sinking braided line with dense round cross-section and low stretch. Slippery line allows to reach maximum casting distances and accuracy.

- Sinking
- High strength
- Increased durability
- High sensitivity
- Maximum casting distance
- All-season usage
- Dark brown color



STRENGTH TABLE

Diameter (MM)	0,113	0,131	0,153	0,172
Test (kg)	4,72	6,35	8,44	9,25

ITEM NO.	DIAM. (MM)	SIZE #	LENGTH (M)	COLOUR	Q-TY IN PACKAGE
FC4909-011	0,113	0,6	150	dark brown	ind. pack.
FC4909-013	0,131	0,8	150	dark brown	ind. pack.
FC4909-015	0,153	1,0	150	dark brown	ind. pack.
FC4909-017	0,172	1,2	150	dark brown	ind. pack.

## MONOFILAMENT FISHING LINE FEEDER CONCEPT DISTANCE BLACK

Monofilament fishing line specially designed for feeder fishing. Maximum sensitivity and minimal stretch ability. Perfect combination of price and quality. Black color makes it invisible to fish.



STRENGTH TABLE

Diameter (MM)	0,22	0,25	0,27	0,30
Test (kg)	4,15	5,20	5,90	6,70

ITEM NO.	DIAM. (MM)	LENGTH (M)	COLOUR	Q-TY IN PACKAGE
FC4001-022	0,22	150	black	ind. pack.
FC4001-025	0,25	150	black	ind. pack.
FC4001-027	0,27	150	black	ind. pack.
FC4001-030	0,30	150	black	ind. pack.

# FEEDER CONCEPT

## FLAT METHOD SET



ITEM NO.	MODEL	WEIGHT	CAGE LENGTH/ MM	DIAMETR/ MM	FULL LENGTH/ MM
7009-0**	Flat Method	40, 60, 80	55	32	75
7009-468	Flat method set	set with 40, 60, 80	55	32	75

## FLAT MOULD



ITEM NO.	MODEL	MATERIAL
7010-000	Flat Mould	mould

## FEEDER CONCEPT NANO PLUS AND PROFI PLUS



ITEM NO.	WEIGHT	CAGE LENGTH/ MM	DIAMETR/ MM	FULL LENGTH/ MM
7015-	20, 30, 40, 50, 60	45	32	70
7016-	40, 60, 80, 90, 120	55	38	90

## FEEDER CONCEPT NANO CAGE AND PROFI CAGE



ITEM NO.	WEIGHT	CAGE LENGTH/MM	DIAMETR/MM	FULL LENGTH/MM
7011-	20, 30, 40, 50, 60	45	32	70
7012-	40, 60, 80, 90, 120	55	38	90

## FEEDER CONCEPT NANO OVAL AND PROFI OVAL



ITEM NO.	WEIGHT	CAGE LENGTH/MM	DIAMETR/MM	FULL LENGTH/MM
7013-	20, 30, 40, 50, 60	45	32	70
7014-	40, 60, 80, 90, 120	55	38	90
7014-068	set with 60 and 80	55	38	90

## V-BULLET



ITEM NO.	WEIGHT	CAGE LENGTH/MM	DIAMETR/MM	FULL LENGTH/ML
FCMC-VB-040	40	37	27	21
FCMC-VB-050	50	39	27	22
FCMC-VB-070	70	43	27	25
FCMC-VB-090	90	46	27	26

## SPORT M



ITEM NO.	WEIGHT	CAGE LENGTH/MM	DIAMETR/MM	FULL LENGTH/ML
FCMC-SM-040	40	30	27	17
FCMC-SM-060	60	30	27	17
FCMC-SM-080	80	37	27	21
FCMC-SM-100	100	37	27	21
FCMC-SM-120	120	37	27	21
FCMC-SM-140	140	45	27	26

## FEEDER CONCEPT CLAW S **NEW**



ITEM NO.	WEIGHT	CAGE LENGTH/MM	DIAMETR/ MM	FULL LENGTH/ ML
FCMC-CS-015	15	41	20	9
FCMC-CS-020	20	46	20	9
FCMC-CS-025	25	50	20	9
FCMC-CS-030	30	53	20	9
FCMC-CS-035	35	58	20	9
FCMC-CS-040	40	61	20	9

## FEEDER CONCEPT CLAW M **NEW**



ITEM NO.	WEIGHT	CAGE LENGTH/MM	DIAMETR/ MM	FULL LENGTH/ ML
FCMC-CM-040	40	62	25	19
FCMC-CM-050	50	66	25	19
FCMC-CM-060	60	69	25	19
FCMC-CM-070	70	72	25	19
FCMC-CM-080	80	75	25	19

## FEEDER CONCEPT CLAW L **NEW**

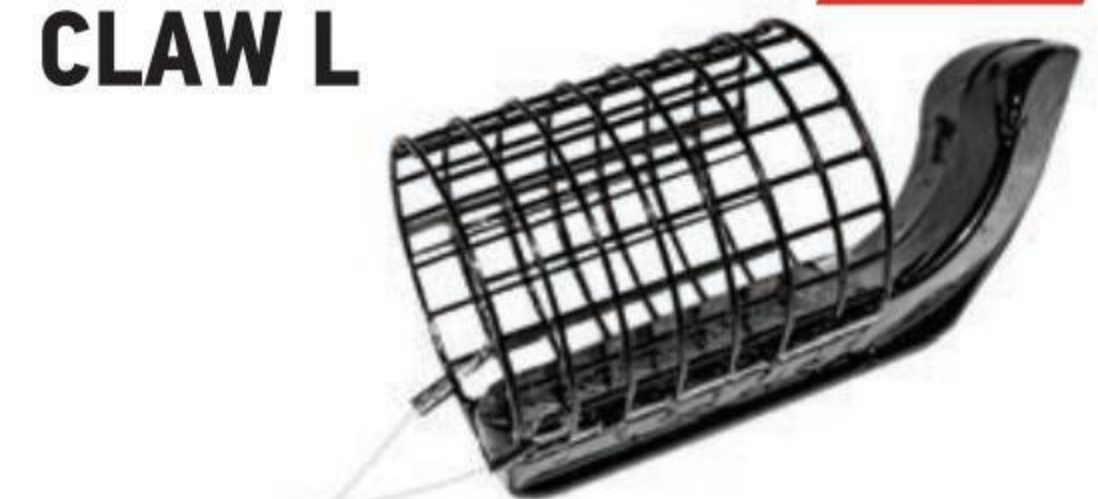

ITEM NO.	WEIGHT	CAGE LENGTH/MM	DIAMETR/ MM	FULL LENGTH/ ML
FCMC-CL-080	80	79	30	35
FCMC-CL-090	90	82	30	35
FCMC-CL-100	100	84	30	35
FCMC-CL-110	110	87	30	35
FCMC-CL-120	120	89	30	35

## VEGAS FEEDERS FOR FEEDER CONCEPT

### CAGE SMALL AND LARGE



ITEM NO.	MODEL	WEIGHT	CAGE LENGTH/ MM	DIAMETR/ MM	FULL LENGTH/ MM
7001-0**	Cage small	14, 25, 40, 50	32	27	64
7002-0**	Cage large	22, 30, 42, 56, 80	40	33	80

### OVAL SMALL AND LARGE



ITEM NO.	MODEL	WEIGHT	CAGE LENGTH/ MM	DIAMETR/ MM	FULL LENGTH/ MM
7003-0**	Oval small	7, 14, 25, 40, 50	32	27	64
7004-0**	Oval large	22, 30, 42, 56, 80	40	33	80
7004-468	Oval large	set with 42, 56 and 80	40	33	80

### RIVER CAGE LARGE



ITEM NO.	MODEL	WEIGHT	CAGE LENGTH/ MM	DIAMETR/ MM	FULL LENGTH/ MM
7005-***	River cage large	60, 80, 100, 120	55	38	90
7005-681	River large	set with 60, 80 and 100	55	38	90

### RIVER OVAL LARGE



ITEM NO.	MODEL	WEIGHT	CAGE LENGTH/ MM	DIAMETR/ MM	FULL LENGTH/ MM
7006-***	River oval large	60, 80, 100, 120	55	38	90

### RIVER PLUS LARGE



ITEM NO.	MODEL	WEIGHT	CAGE LENGTH/ MM	DIAMETR/ MM	FULL LENGTH/ MM
7007-***	River plus large	60, 80, 100, 120	55	38	90

### BULLET



ITEM NO.	MODEL	WEIGHT	CAGE LENGTH/ MM	DIAMETR/ MM	FULL LENGTH/ MM
7008-***	Bullet	40, 60, 80, 100	40	30	70

### BULLET SET



ITEM NO.	MODEL	WEIGHT	CAGE LENGTH/ MM	DIAMETR/ MM	FULL LENGTH/ MM	КОЛ-ВО, ШТ.
7008-046	Bullet set	set with 40 and 60	40	30	70	2
7008-468	Bullet set	set with 40, 80 and 60				3

# FEEDER CONCEPT

## SNELLED HOOKS FEEDER CONCEPT FEEDER FC104

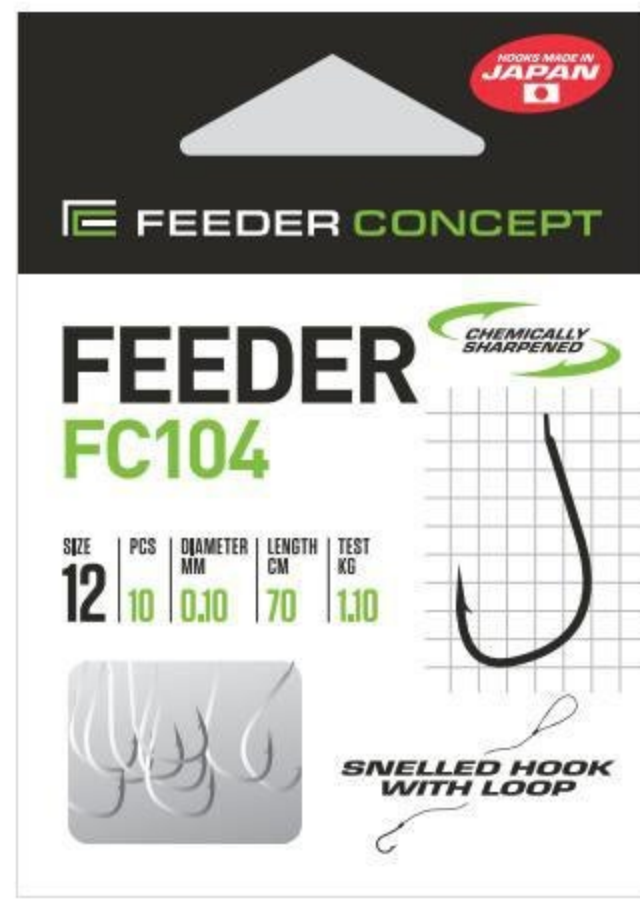

ITEM NO.	HOOK SIZE	LENGTH (CM)	DIAMETER (MM)	Q-TY IN A PACKAGE (PCS.)
FC104-006-016	6	70	0,16	10
FC104-008-014	8	70	0,14	10
FC104-010-012	10	70	0,12	10
FC104-012-010	12	70	0,10	10

## SNELLED HOOKS FEEDER CONCEPT FEEDER FC105



ITEM NO.	HOOK SIZE	LENGTH (CM)	DIAMETER (MM)	Q-TY IN A PACKAGE (PCS.)
FC105-004-020	4	70	0,20	10
FC105-006-018	6	70	0,18	10
FC105-008-018	8	70	0,18	10
FC105-010-016	10	70	0,16	10
FC105-012-014	12	70	0,14	10

## SNELLED HOOKS FEEDER CONCEPT FEEDER FC106



ITEM NO.	HOOK SIZE	LENGTH (CM)	DIAMETER (MM)	Q-TY IN A PACKAGE (PCS.)
FC106-004-018	4	70	0,18	10
FC106-006-016	6	70	0,16	10
FC106-008-016	8	70	0,16	10
FC106-010-014	10	70	0,14	10
FC106-012-012	12	70	0,12	10

## MARKER LEAD



ITEM NO.	WEIGHT (G)
FCML-BM-060	60
FCML-BM-080	80

## HOOK REMOVER FEEDER CONCEPT



ITEM NO.	LENGTH (CM)
FC9830	14

## HOOK REMOVER FEEDER CONCEPT



ITEM NO.	LENGTH (CM)
FC9831	15,5
FC9832	15,5
FC9833	15,5

## SWIVEL WITH INTERLOCK



ITEM NO.	Q-TY IN PACKAGE (PCS.)
FC906-006	7
FC906-007	7

## MOVING ROLLING SWIVEL WITH INTERLOCK



ITEM NO.	Q-TY IN PACKAGE (PCS.)
FC907-001S	5

## SILICON STOPPERS

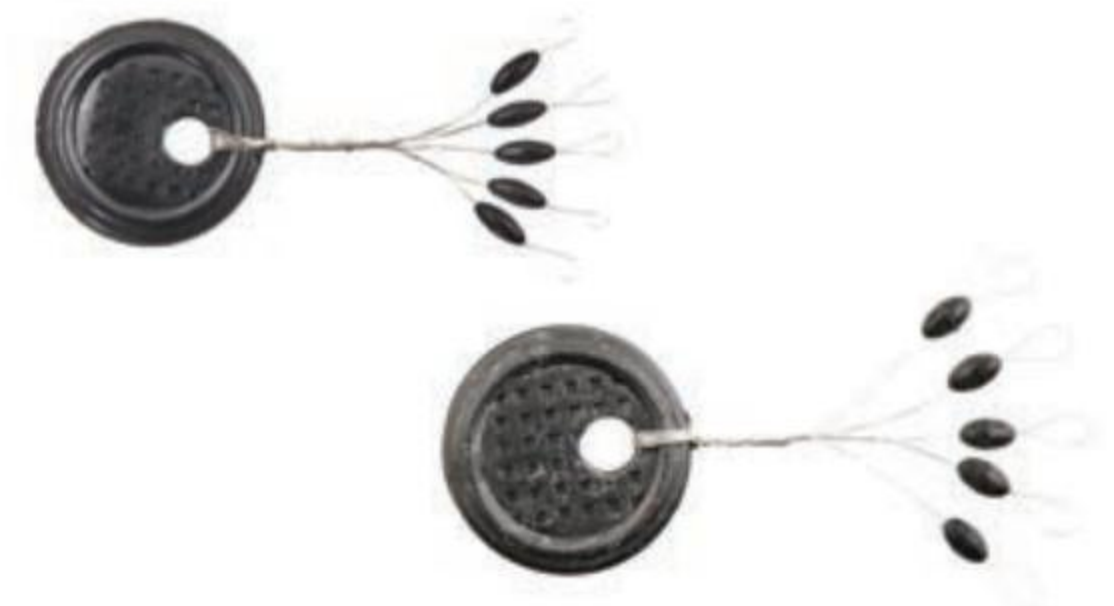

ITEM NO.	SIZE	Q-TY IN PACKAGE (PCS.)
FC908-001S	S	5
FC908-002M	M	5
FC908-003L	L	5



## FEEDER CONCEPT EVA RIG SPOOL **NEW**



ITEM NO.	DIAM. (CM)	HEIGHT (CM)	Q-TY IN PACKAGE (PCS.)
FC8000	10	1,8	10
FC8001	8	1,8	10

## FEEDER CONCEPT DISTANCE MEASURING POLES **NEW**



ITEM NO.	LENGTH (CM)	CORD LENGTH (M)	MATERIAL
FC090-300DMS	90	3	aluminum

## ROD HOLDER TELESCOPIC



FC030-050BSK



FC050-085BSK



FC080-145BSK

ITEM NO.	LENGTH/CM	MATERIAL
FC030-050BSK	30-50	EVA
FC050-085BSK	50-85	EVA
FC080-145BSK	80-145	EVA

## ROD HOLDER **EVA**



FC3500



FC4500



FC6000

ITEM NO.	LENGTH/CM	MATERIAL
FC3500	35	EVA
FC4500	45	EVA
FC6000	60	EVA

## TRIPOD

TRIPOD rod holder.

- Lightweight
- Very stable
- Extending centre pole
- Standard screw fitting
- Material - aluminium
- Height - 60 cm, 120 cm



FC060-2TPD



FC120-3TPD

ITEM NO.	HEIGHT (CM)	MATERIAL
FC060-2TPD	60	Aluminium
FC120-3TPD	120	Aluminium

# FEEDER CONCEPT

## ROD HOLDER PLASTIC



FCL000



FCU000

ITEM NO.	LENGTH/CM	MATERIAL
FCL000	L- shape	plastic
FCU000	U-shape	plastic

## KEEPNET

Keep net with adjustable entry angle. Made of durable and fast-drying material that does not absorb the specific smell of fish. Material – PVC Micro net.



ITEM NO.	TOP RING SIZE	LENGTH (CM)	COLOR	MATERIAL
FC5040-300KN	50 x 40	300	Black	PVC Micro net
FC5040-400KN	50 x 40	400	Black	PVC Micro net
<b>NEW</b> FC3040-150KNS	30 x 40	150	Green	polyester
<b>NEW</b> FC3040-200KNS	30 x 40	200	Green	polyester
<b>NEW</b> FC3040-250KNS	30 x 40	250	Green	polyester

## ROD BELT SET FEEDER CONCEPT



ITEM NO.	BRAND
FC262	Feeder Concept

## LANDING NET HANDLE FROM HIGH MODULUS GRAPHITE

High modulus graphite landing net handle. Over steak handle allows you to quickly change the length from 2 to 4 meters.

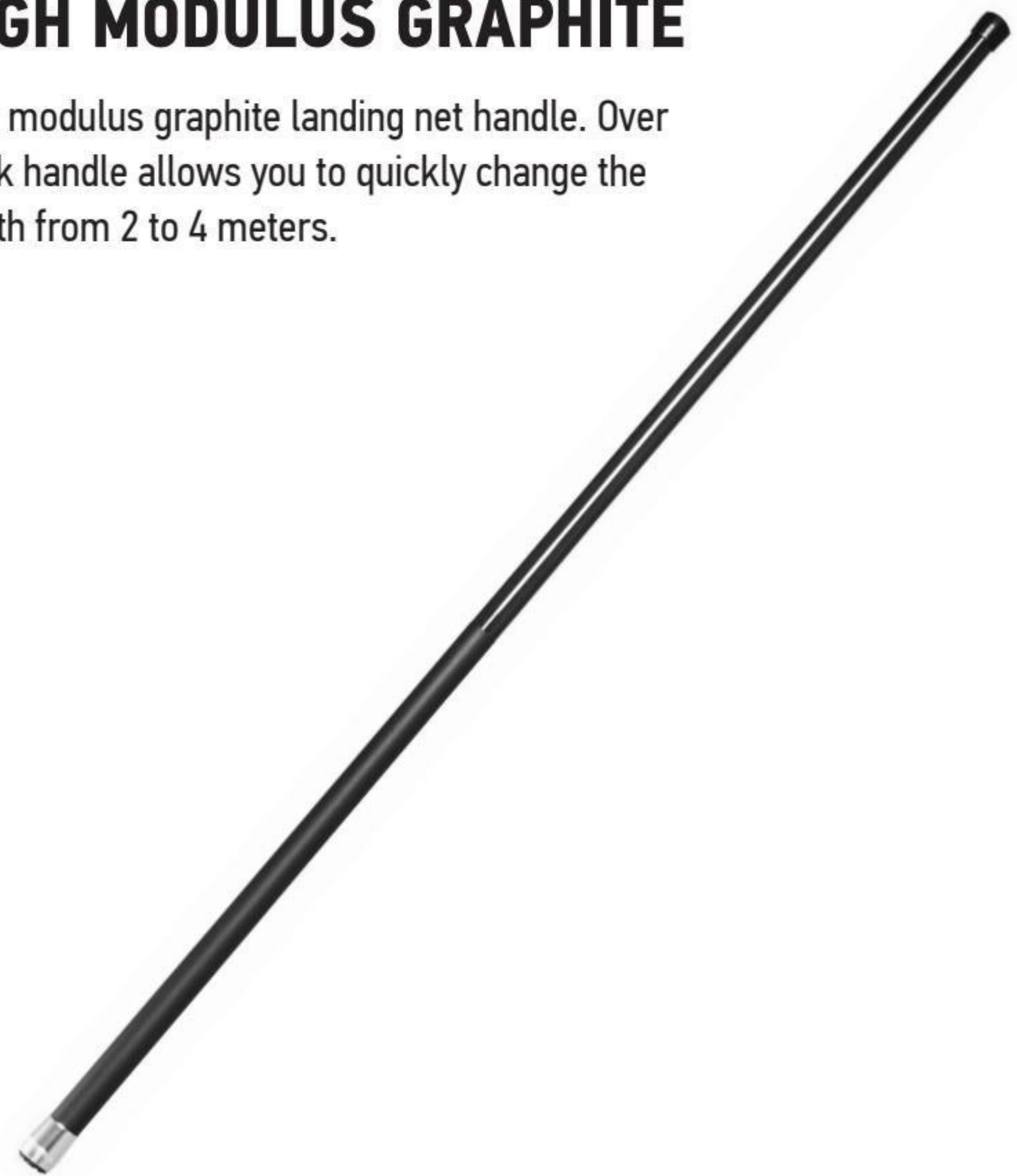

ITEM NO.	LENGTH (CM)	TRANSPORT LENGTH (CM)	MATERIAL
FC400LNH	200 to 400	117	Carbon
FC300LNF	200 to 300	117	Carbon

## LANDING NET HEAD FEEDER CONCEPT

Landing net head with rubberized net, which is less traumatic for fish and makes it easier to remove hooks that get caught. Size – 50 x 40 cm. Mesh size – 0,5 x 0,5 cm. Material – rubberized polyester.



ITEM NO.	HEAD SIZE (CM)	CELL (CM)	MATERIAL
FC4542-050	50 x 40	0,5 x 0,5	rubberized polyester

## LANDING NET HEAD FEEDER CONCEPT

Lightweight floating landing net head. Reinforced fixation to the handle. Material – 7 mm nylon.



ITEM NO.	HEAD SIZE (CM)	MATERIAL
FC3535-025LN	35 x 35	7 mm nylon
FC4535-025LN	45 x 35	7 mm nylon
FC5040-025LN	50 x 40	7 mm nylon
FC5040-025LNL	50 x 40	nylon
FC5040-350KNE	50 x 40 x 350	
FC5040-300KNR	50 x 40 x 300	
FC5040-400KNR	50 x 40 x 400	

## FEEDER CONCEPT EVA FEED BAGS

Universal, durable, lightweight, 100% waterproof set of containers. These containers are great solution for storing feed and various baits during feeder or match fishing. The containers are easy to store in each other. Material – EVA. The set includes 5 containers – 36 x 25,5 x 9 cm; 33 x 10,5 x 8 cm; 13 x 9 x 8 cm (3 pcs).



ITEM NO.	SIZE (CM)	QTY
FC103B	36 x 25,5 x 9 33 x 10,5 x 8 13 x 9 x 8 (3 pcs)	5

## FEEDER CONCEPT EVA FEED BAGS

Universal, durable, lightweight, 100% waterproof set of accessory cases with transparent lids for easy tackle identification. These cases are perfect for organizing and storing baits, accessories, and various other fishing tackle items. The cases are easy to store in each other. Material – EVA. The set includes 3 cases – 27 x 17 x 10 cm; 24 x 15,5 x 9,5 cm; 21 x 14,5 x 8 cm.



ITEM NO.	SIZE (CM)	QTY
FC104B	27 x 17 x 10 24 x 15,5 x 9,5 21 x 14,5 x 8	3

## FEEDER CONCEPT EVA FEED BAGS

Universal, durable, lightweight, 100% waterproof set of accessory cases with transparent lids for easy tackle identification. These cases are perfect for organizing and storing baits, accessories, and various other fishing tackle items. The cases are easy to store in each other. Material – EVA. The set includes 5 cases – 36 x 25,5 x 9 cm; 33 x 10,5 x 8 cm; 13 x 9 x 8 cm (3 pcs).



ITEM NO.	SIZE (CM)	QTY
FC105B	36 x 25,5 x 9 33 x 10,5 x 8 13 x 9 x 8 (3 pcs)	5

## FEEDER CONCEPT KEEPNET CASE



ITEM NO.	SIZE (CM)
FC113B	58 x 49 x 10

## FEEDER CONCEPT **EVA KEEPNET CASE LARGE**

Waterproof case for keepnet transporting and storing. Equipped with comfortable, non-slippery rubber handles and shoulder strap. Made of EVA material. Easy to wash. Size – 60 x 22 x 50 cm.



ITEM NO.	SIZE (CM)
FC6022-050EKNB	60 x 22 x 50

## FEEDER CONCEPT **EVA KEEPNET CASE**

Waterproof case for keepnet transporting and storing. Equipped with comfortable, non-slippery rubber handles and shoulder strap. Made of EVA material. Easy to wash. Size – 60 x 13 x 50 cm.



ITEM NO.	SIZE (CM)
FC111B	60 x 13 x 50

## FEEDER CONCEPT **DROP BUCKET**

Foldable bucket for collecting water at places where access to water is difficult. Size – 21 x 21 x 21 cm.



ITEM NO.	SIZE (CM)
FC115B	21 x 21 x 21

## FEEDER CONCEPT **ROD TUBE 2 SECTIONS**



ITEM NO.	SIZE (CM)
FC119B	165 x 18,5 x 23

## FEEDER CONCEPT EVA ALLROUND BAG

**NEW**

Universal, durable, lightweight feeder fishing bag with shoulder strap. 100% waterproof, easy to clean. Material - EVA.



ITEM NO.	SIZE (CM)	MATERIAL	VOLUME (L)
FC4030-025EBAL	40 x 30 x 250	EVA	30,0

## FEEDER CONCEPT EVA COOLER BAG

**NEW**

Cooler bag for groundbait and live bait storage; transportation. 100% waterproof, easy to clean. Material - EVA + thermal foil lining.



ITEM NO.	SIZE (CM)	MATERIAL	VOLUME (L)
FC4526-020EBTH	45 x 26 x 20	EVA	23,5

## FEEDER CONCEPT EVA ROD CASE



ITEM NO.	SIZE (CM)
FC145ERB	146
FC165ERB	165

## FISHING CHAIR FEEDER CONCEPT COMPACT

**NEW**



ITEM NO.	SIZE (CM)	WEIGHT (KG)
FC4447-043CH	47 x 44 x 43/94	5,1



## COBRA HOOKS

High quality COBRA hooks are manufactured in Korea based on following components:

- high quality carbon alloy steel
- electrochemical hook point sharpening
- corrosion resistant coating
- innovative heat treatment technology
- laser quality control of sharpening

### HOOKS COBRA **CC303**



**Bait:** all kinds  
**Fish:** medium and large  
**Fishing type:** bottom  
**Color:** black nickel  
**Hook type:** eyed

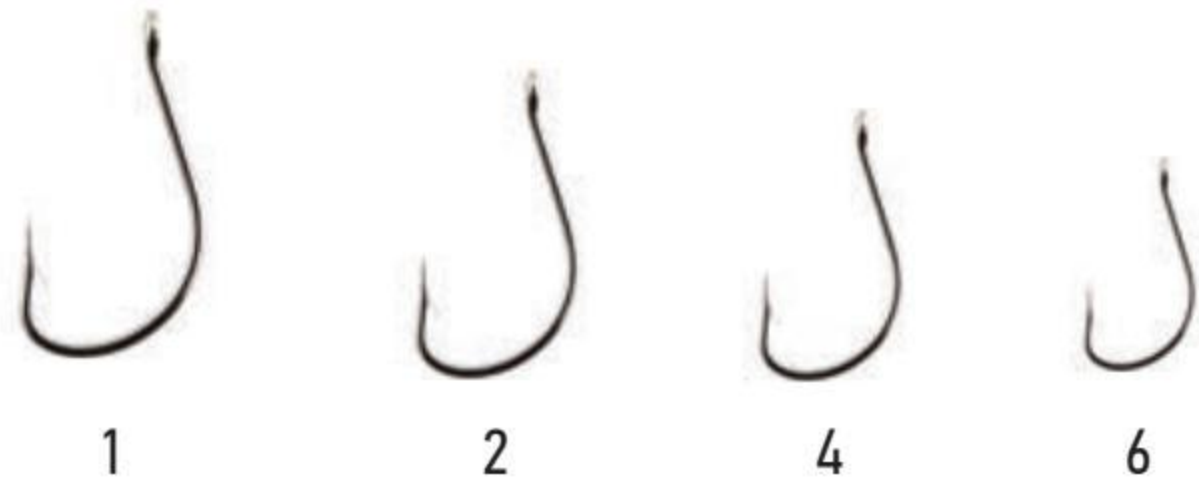

ITEM NO.	SIZE	Q-TY IN A PACK (PCS.)
CC303-002	2	8
CC303-004	4	8
CC303-006	6	10
CC303-008	8	10

### HOOKS COBRA **ALLROUND CA112**

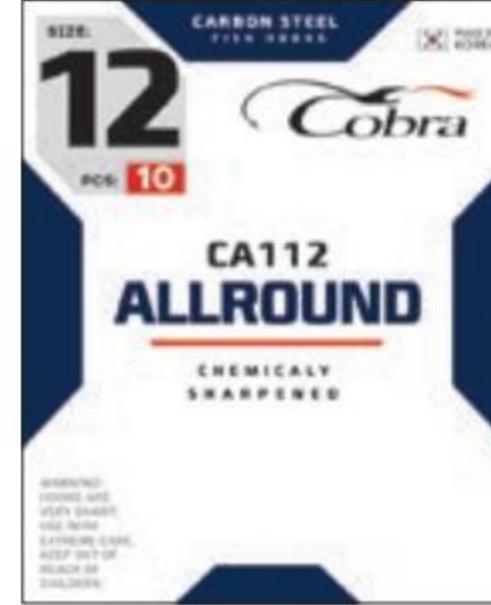

**Bait:** all kinds  
**Fish:** medium and large  
**Fishing type:** float and bottom  
**Color:** black nickel  
**Hook type:** eyed

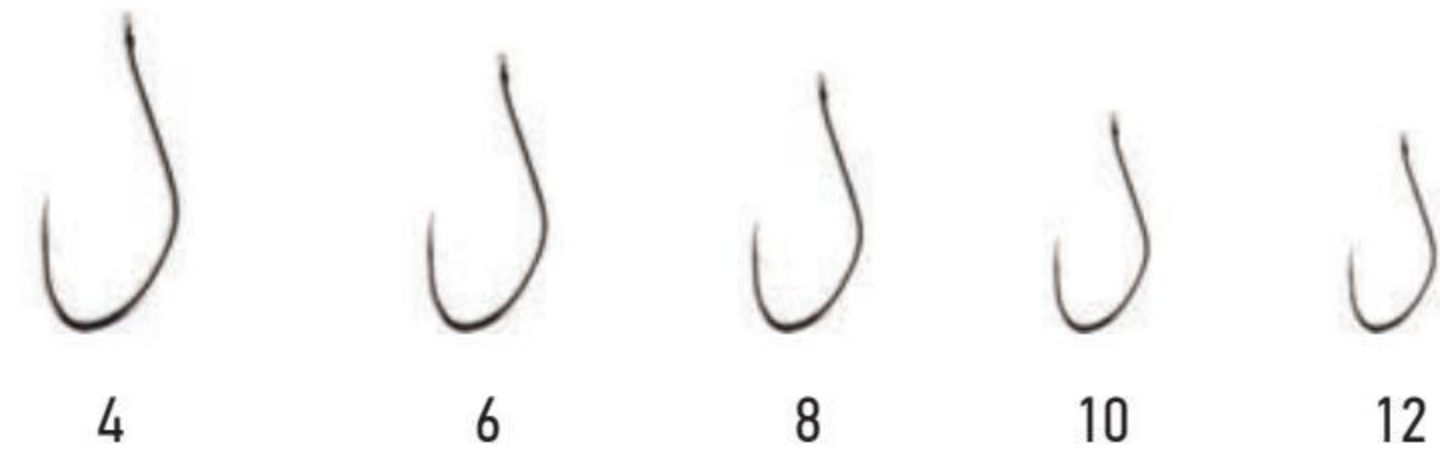

ITEM NO.	SIZE	Q-TY IN A PACK (PCS.)
CA112-004	4	10
CA112-006	6	10
CA112-008	8	10
CA112-010	10	10
CA112-012	12	10



## HOOKS COBRA ALLROUND CA114/CA114G



**Bait:** all kinds  
**Fish:** medium and large  
**Fishing type:** float and bottom  
**Color:** bronze, gold  
**Hook type:** eyed

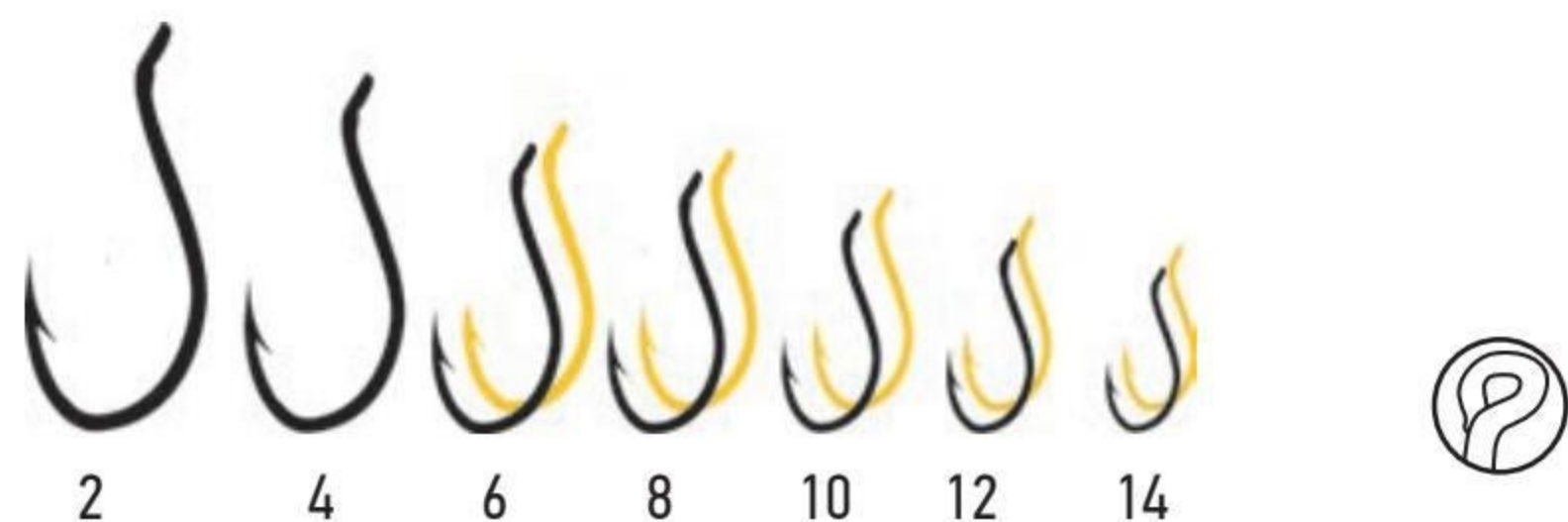

ITEM NO.	SIZE	Q-TY IN A PACK (PCS.)
CA114-***	002; 004; 006; 008; 010; 012; 014	10
CA114G-***	010; 012; 014	10

## HOOKS COBRA ALLROUND CA115

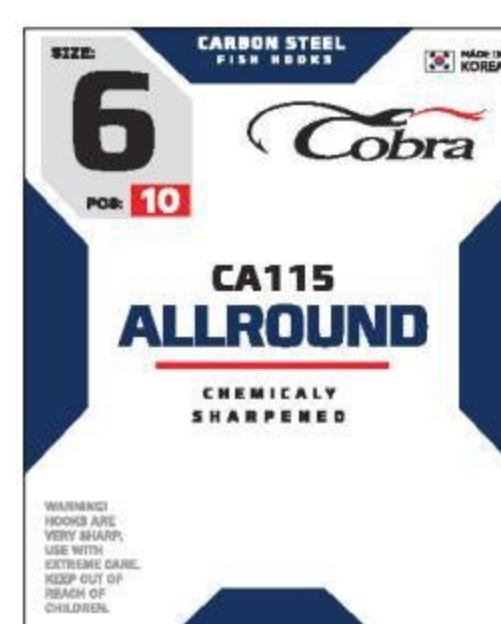

**Bait:** all kinds  
**Fish:** medium and large  
**Fishing type:** float and bottom  
**Color:** red  
**Hook type:** eyed

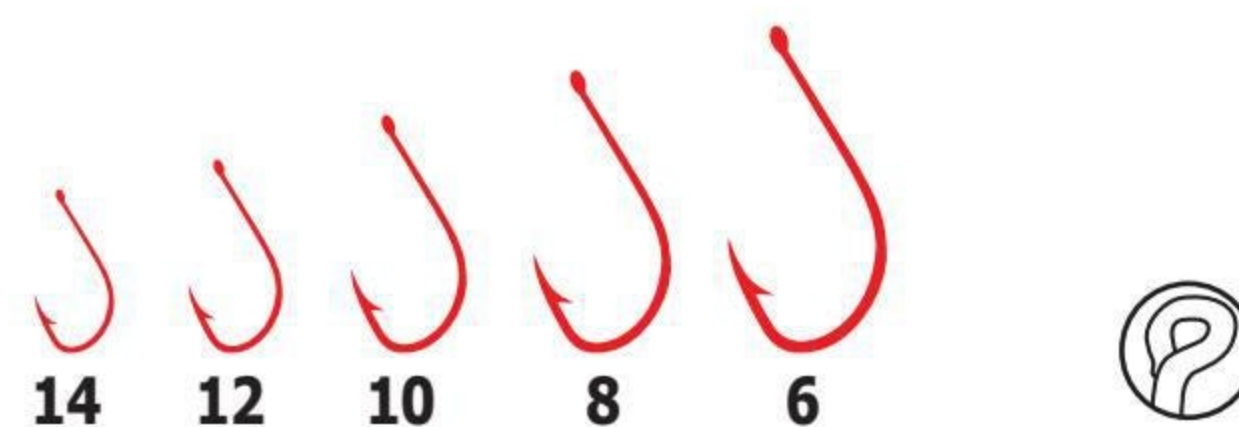

ITEM NO.	SIZE	Q-TY IN A PACK (PCS.)
CA115-***	006; 008; 010; 012; 014	10

## HOOKS COBRA ALLROUND CA116

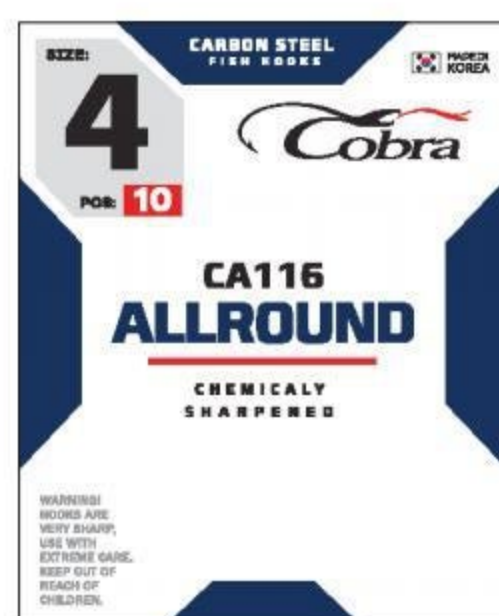

**Bait:** all kinds  
**Fish:** small, medium and large  
**Fishing type:** float and bottom  
**Color:** black nickel  
**Hook type:** eyed

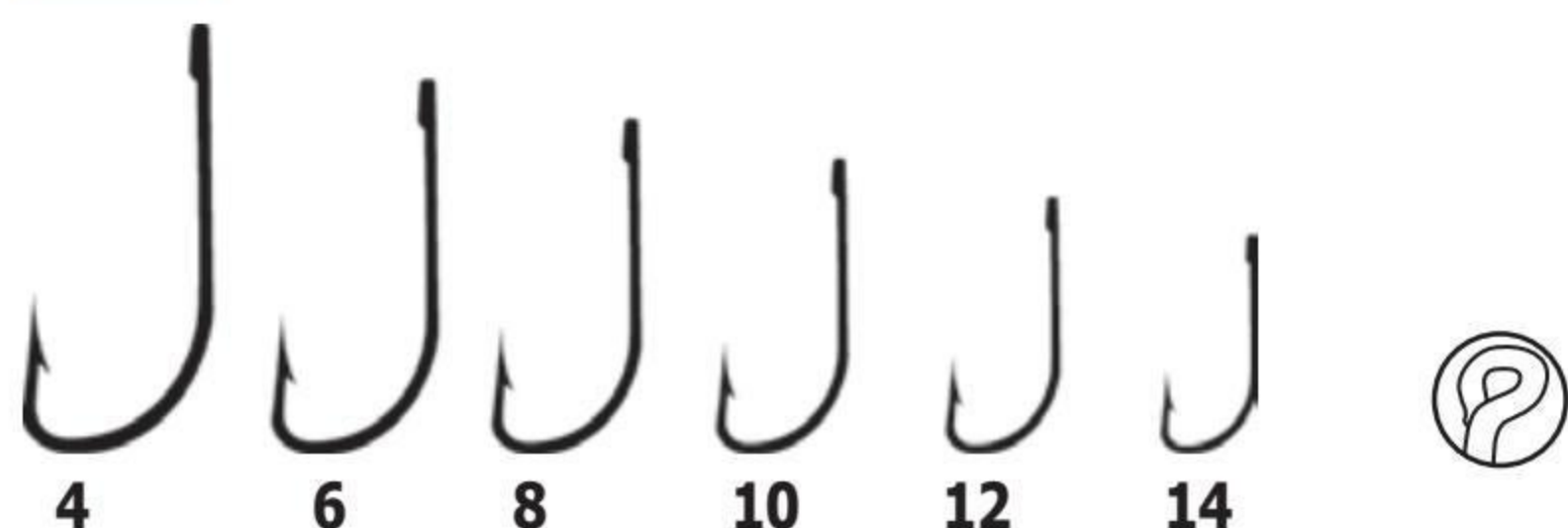

ITEM NO.	SIZE	Q-TY IN A PACK (PCS.)
CA116-***	004; 006; 008; 010; 012; 014	10

## HOOKS COBRA ALLROUND CA117

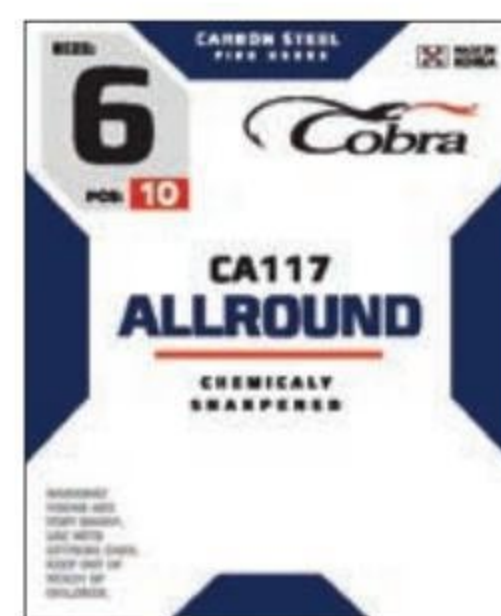

**Bait:** all kinds  
**Fish:** medium and large  
**Fishing type:** bottom  
**Color:** black  
**Hook type:** eyed

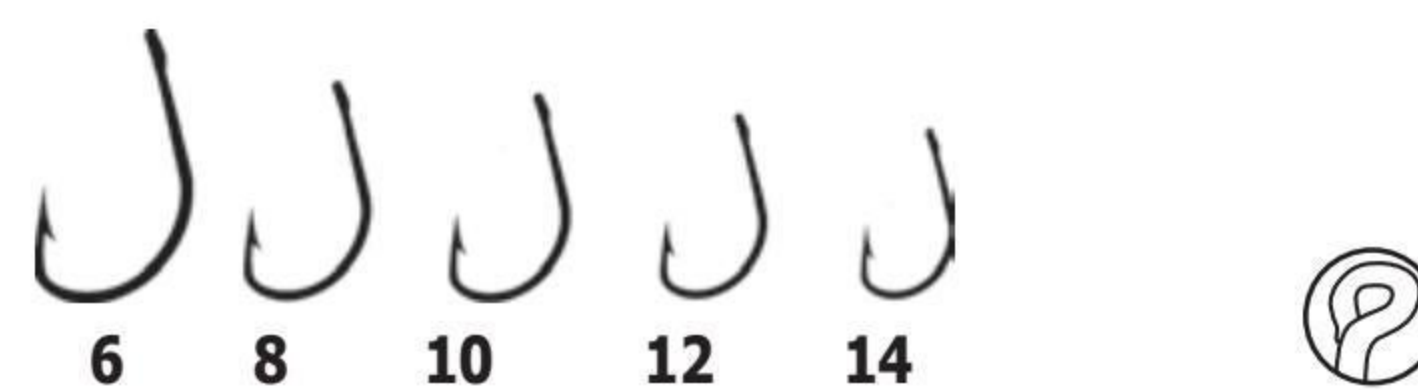

ITEM NO.	SIZE NR. (***)	Q-TY IN A PACK (PCS.)
CA117-***	006; 008; 010; 012; 014	10

## HOOKS COBRA ALLROUND CA118

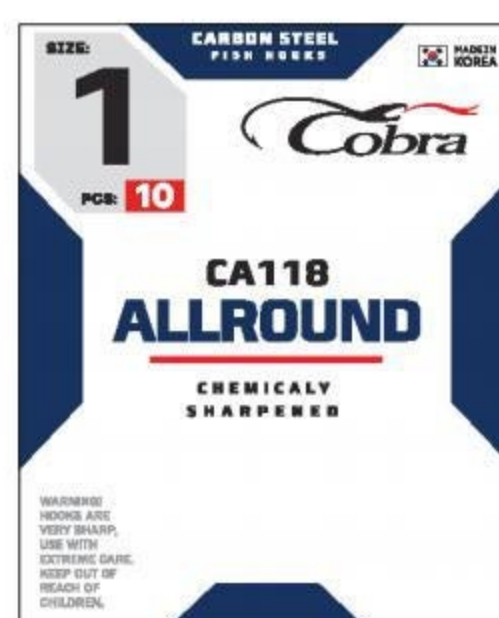

**Bait:** all kinds  
**Fish:** large  
**Fishing type:** float and bottom  
**Color:** black nickel  
**Hook type:** eyed

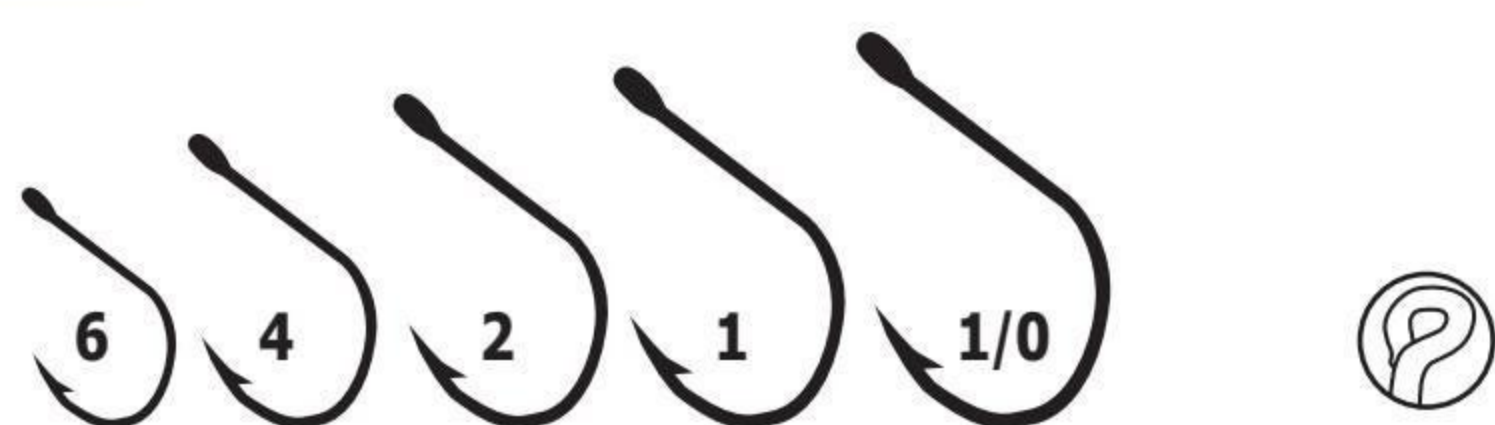

ITEM NO.	SIZE NR. (***)	Q-TY IN A PACK (PCS.)
CA118-K010	1/0	10
CA118-***	001; 002; 004; 006	10

## КЛЮЧКИ COBRA ALLROUND CA119

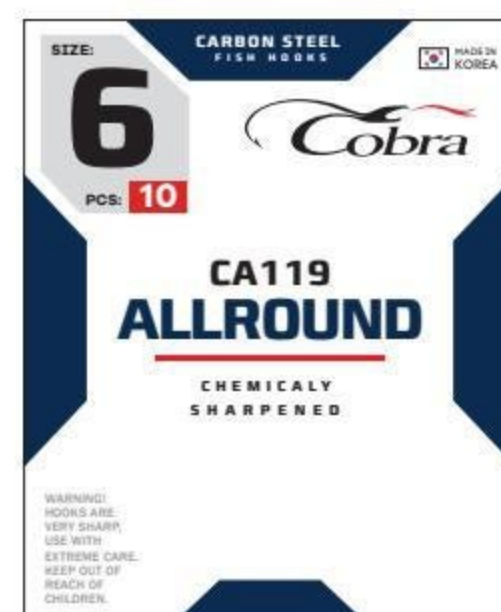

**Bait:** all kinds  
**Fish:** medium and large  
**Fishing type:** bottom  
**Color:** black  
**Hook type:** eyed

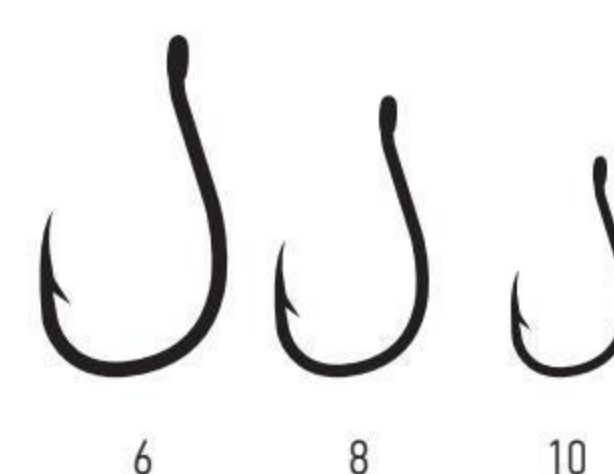

ITEM NO.	SIZE NR. (***)	Q-TY IN A PACK (PCS.)
CA119-***	006; 008; 010	10

THE SIZE OF THE HOOKS DISPLAYED IN THE CATALOGUE CORRESPONDS TO THE ACTUAL HOOK SIZE

## HOOKS COBRA ALLROUND CA121MIX



**Bait:** all kinds  
**Fish:** small, medium and large  
**Fishing type:** float and bottom  
**Color:** MIX – black nickel, red, gold  
**Hook type:** eyed

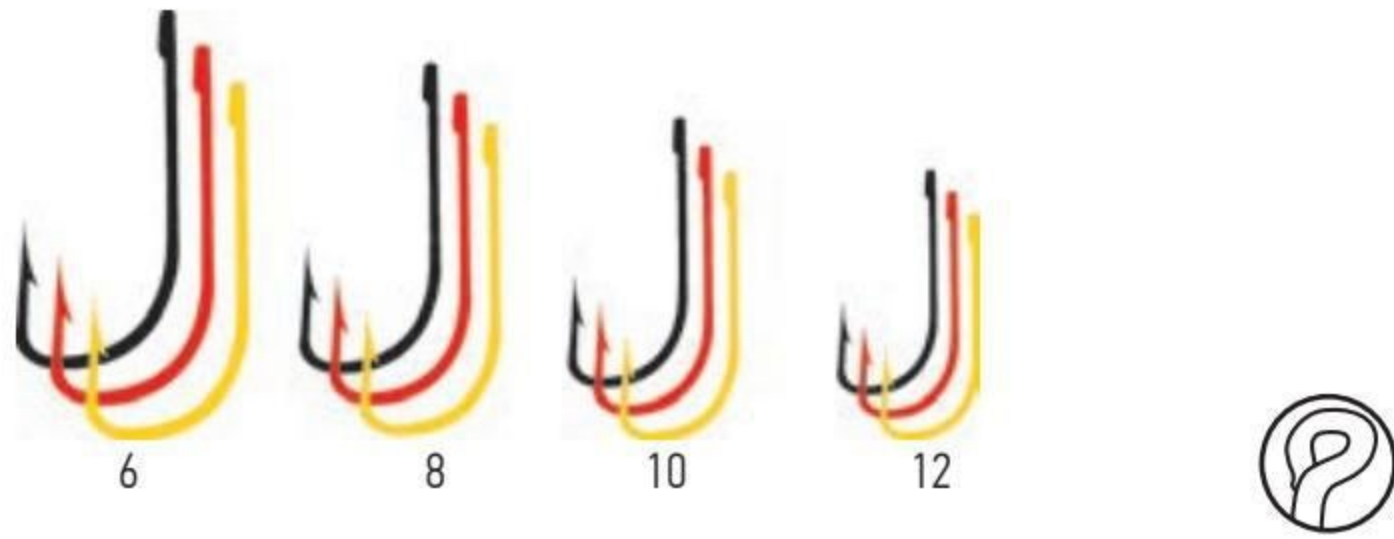

ITEM NO.	SIZE	Q-TY IN A PACK (PCS.)
CA121MIX-***	006; 008; 010; 012	10

## HOOKS COBRA ALLROUND CA124

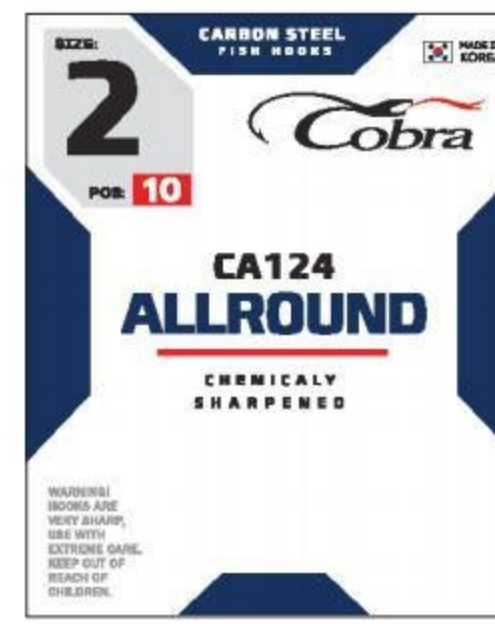

**Bait:** all kinds  
**Fish:** small, medium and large  
**Fishing type:** float and bottom  
**Color:** nickel  
**Hook type:** eyed

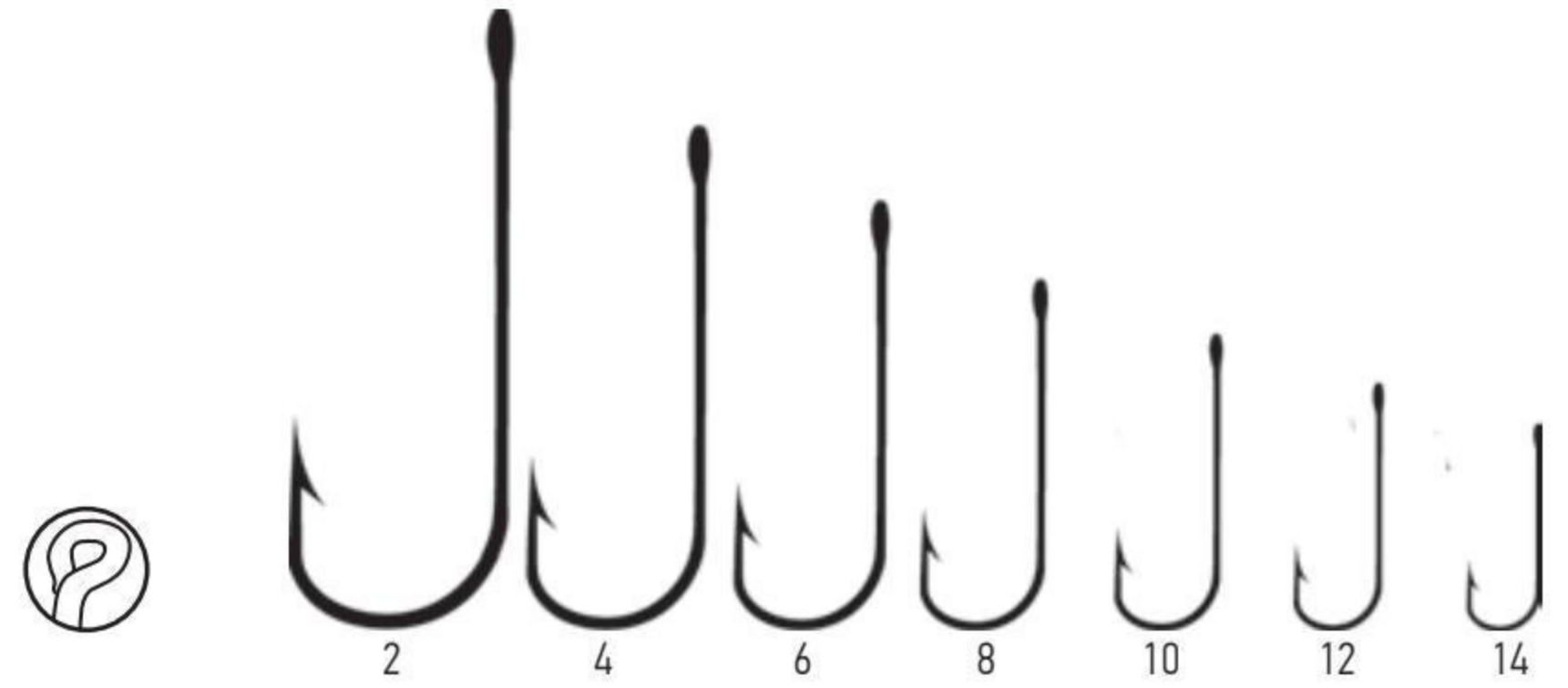

ITEM NO.	SIZE	Q-TY IN A PACK (PCS.)
CA124-***	002; 004; 006; 008; 010; 012; 014	10

## HOOKS COBRA ALLROUND CA125

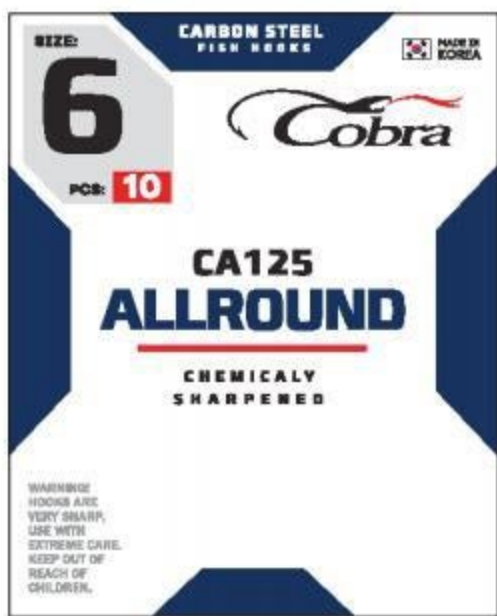

**Bait:** all kinds  
**Fish:** small and medium  
**Fishing type:** float and bottom  
**Color:** black nickel  
**Hook type:** eyed

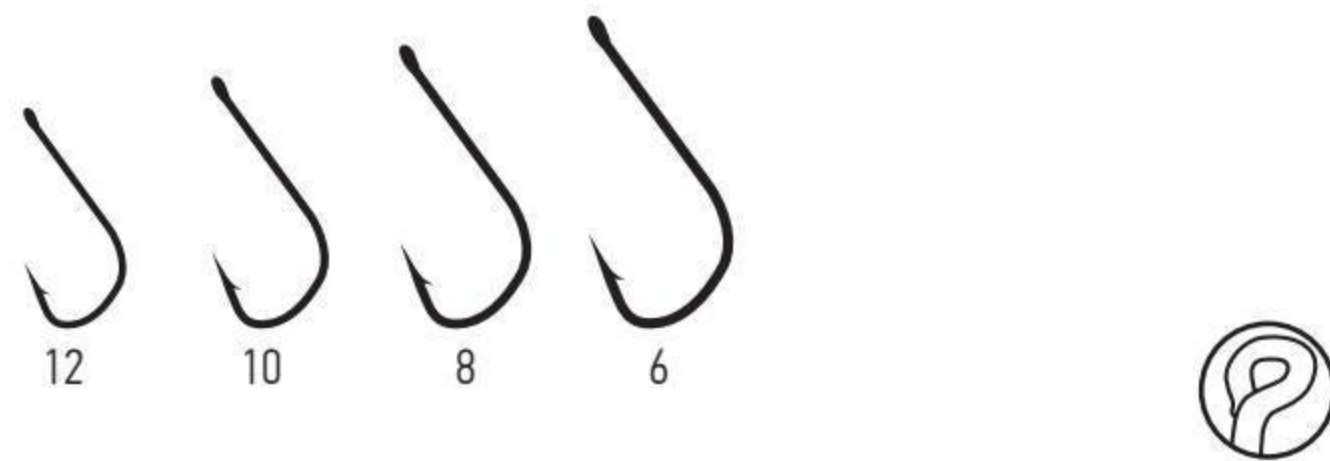

ITEM NO.	SIZE	Q-TY IN A PACK (PCS.)
CA125-***	006; 008; 010; 012	10

## HOOKS COBRA ALLROUND CA126

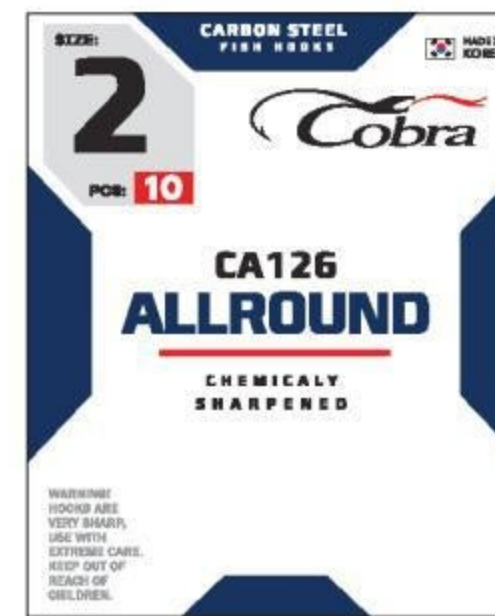

**Bait:** all kinds  
**Fish:** small, medium and large  
**Fishing type:** float and bottom  
**Color:** black nickel  
**Hook type:** eyed

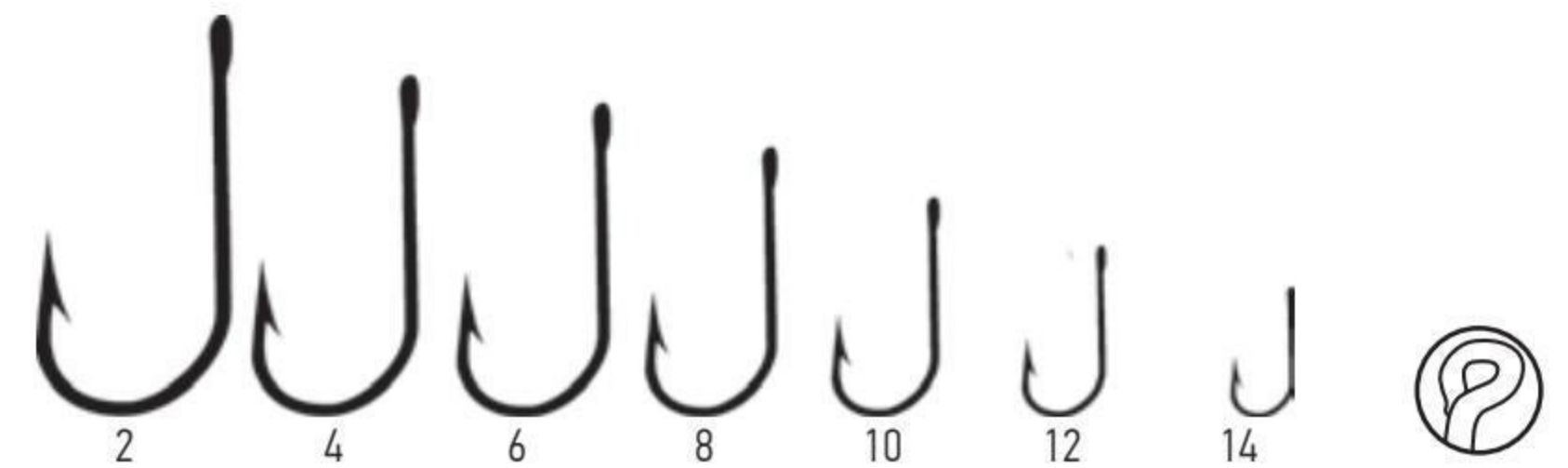

ITEM NO.	SIZE	Q-TY IN A PACK (PCS.)
CA126-***	002; 004; 006; 008; 010; 012; 014	10

## HOOKS COBRA ALLROUND CA127

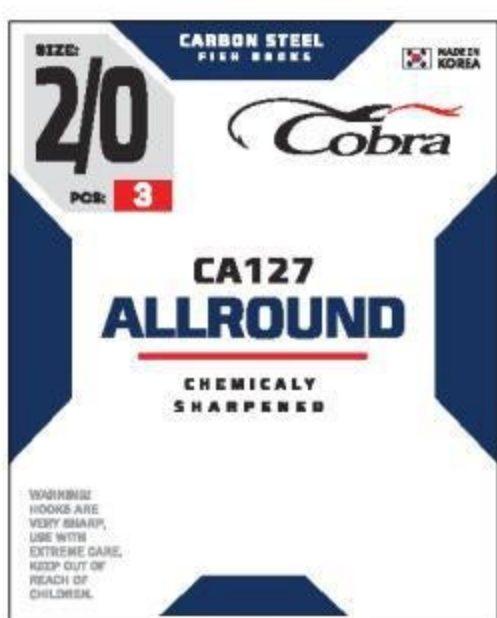

**Bait:** soft plastic  
**Fish:** large  
**Fishing type:** predator fishing  
**Color:** black nickel  
**Hook type:** eyed



ITEM NO.	SIZE	Q-TY IN A PACK (PCS.)
CA127-K030	3/0	3
CA127-K020	2/0	3
CA127-001	1	3

THE SIZE OF THE HOOKS DISPLAYED IN THE CATALOGUE CORRESPONDS TO THE ACTUAL HOOK SIZE



## HOOKS COBRA ALLROUND CA128

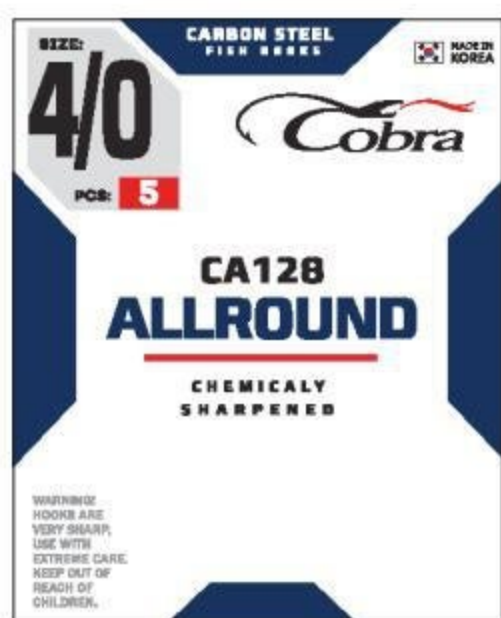

**Bait:** all kinds  
**Fish:** large  
**Fishing type:** float and bottom  
**Color:** black nickel  
**Hook type:** eyed

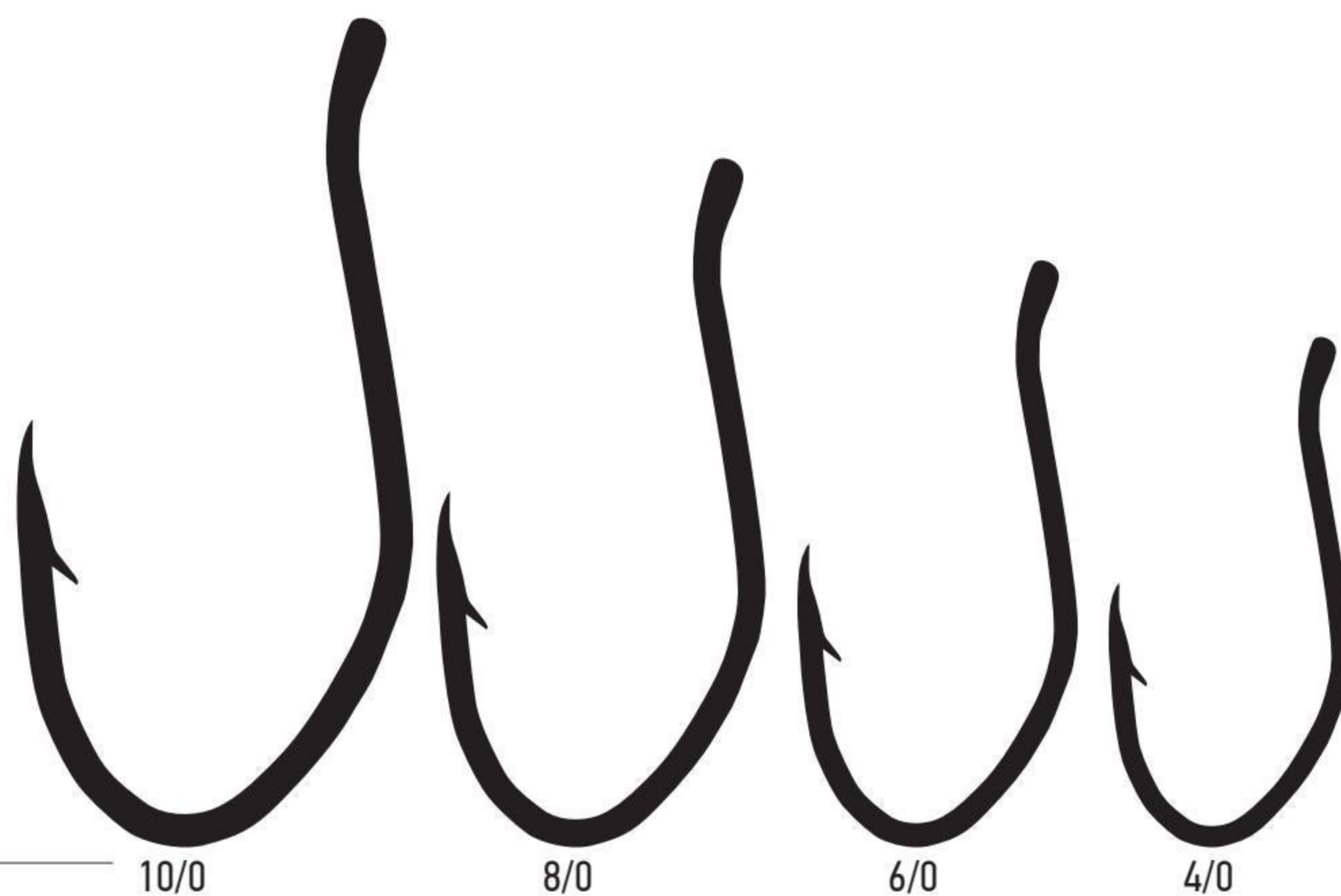

ITEM NO.	SIZE	Q-TY IN A PACK (PCS.)
CA128-K100	10/0	2
CA128-K080	08/0	3
CA128-K060	06/0	4
CA128-K040	04/0	5

## HOOKS COBRA ALLROUND CA129

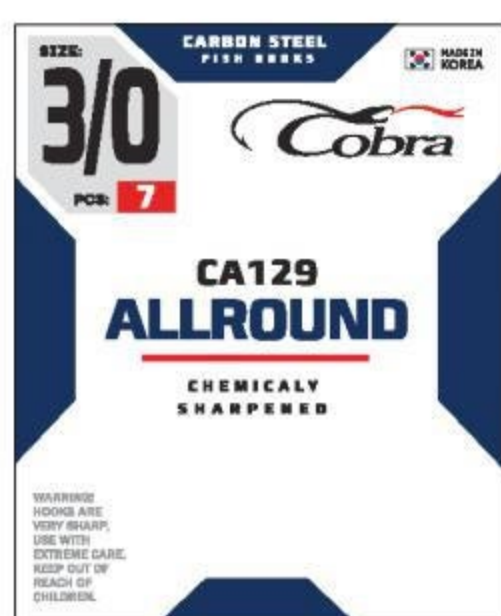

**Bait:** all kinds  
**Fish:** large  
**Fishing type:** float and bottom  
**Color:** black nickel  
**Hook type:** eyed

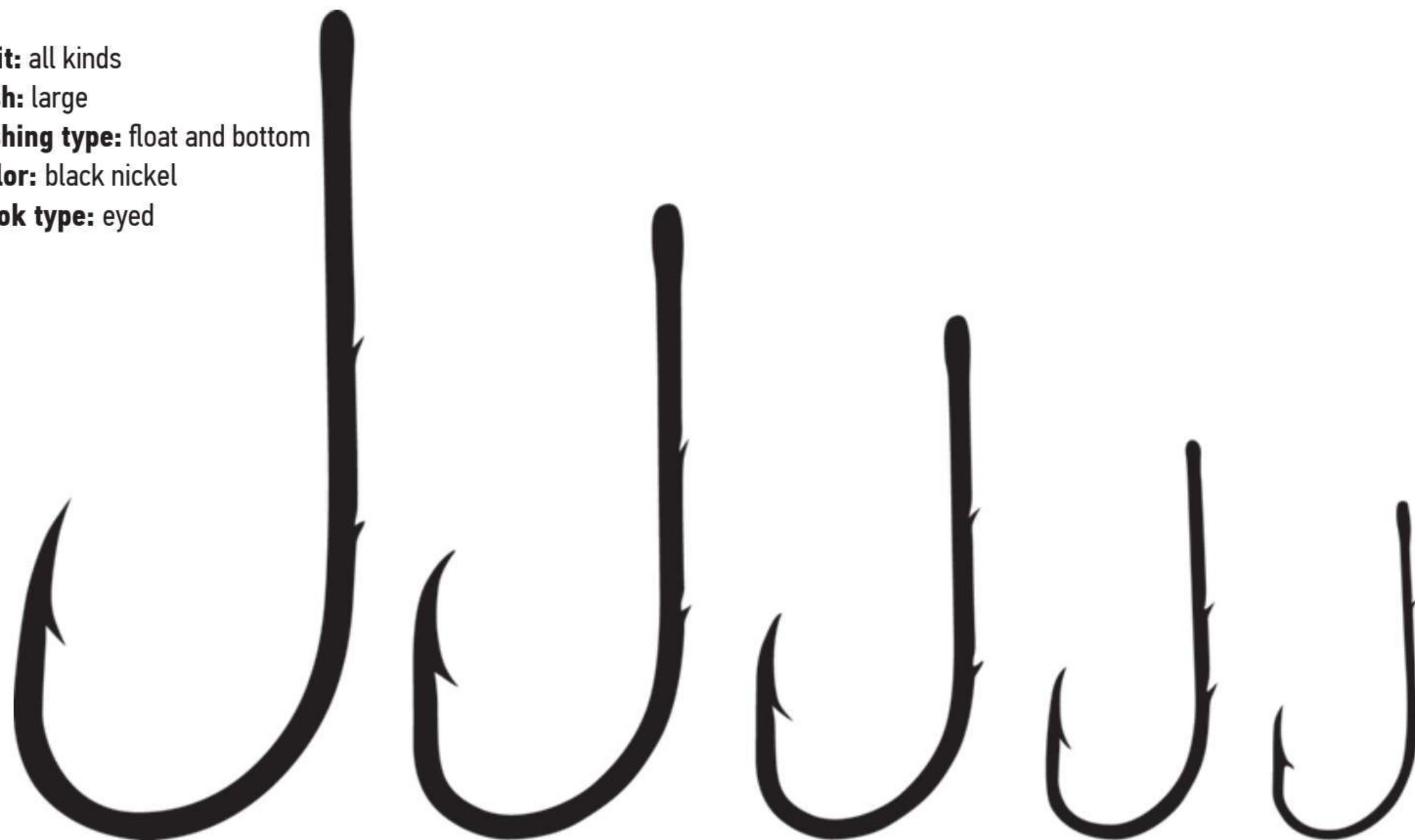

ITEM NO.	SIZE	Q-TY IN A PACK (PCS.)
CA129-K120	12/0	1
CA129-K100	10/0	2
CA129-K080	08/0	3
CA129-K050	05/0	5
CA129-K030	03/0	7

## HOOKS COBRA ALLROUND CA129

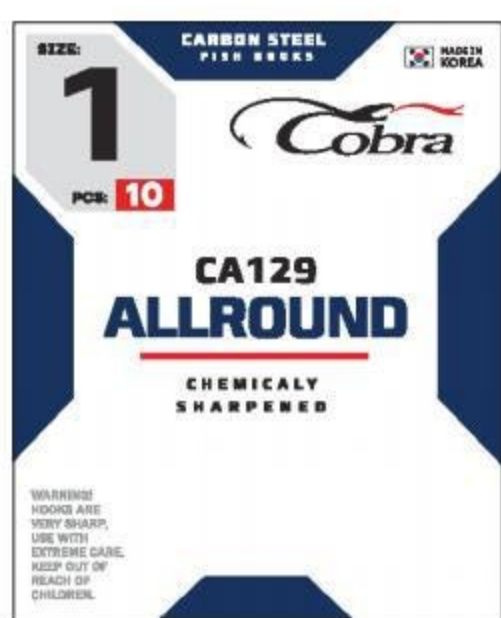

**Bait:** all kinds  
**Fish:** large  
**Fishing type:** float and bottom  
**Color:** black nickel  
**Hook type:** eyed



ITEM NO.	SIZE	Q-TY IN A PACK (PCS.)
CA129-***	001; 002; 004; 006; 008	10

THE SIZE OF THE HOOKS DISPLAYED IN THE CATALOGUE CORRESPONDS TO THE ACTUAL HOOK SIZE

## COBRA HOOKS FEEDER

COBRA FEEDER hooks are hooks' series specially designed for enthusiast of feeder fishing. The catalog presents three classic models of these hooks.

- high quality carbon alloy steel
- corrosion resistant coating
- laser quality control of sharpening
- electrochemical hook point sharpening
- innovative heat treatment technology
- Made in Korea

### HOOKS COBRA FEEDER **CF205**

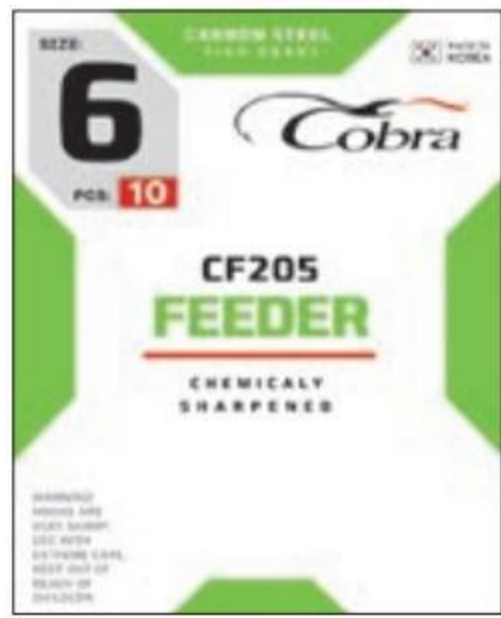

**Bait:** all kinds  
**Fish:** medium and large  
**Fishing type:** feeder  
**Color:** black nickel  
**Hook type:** eyed

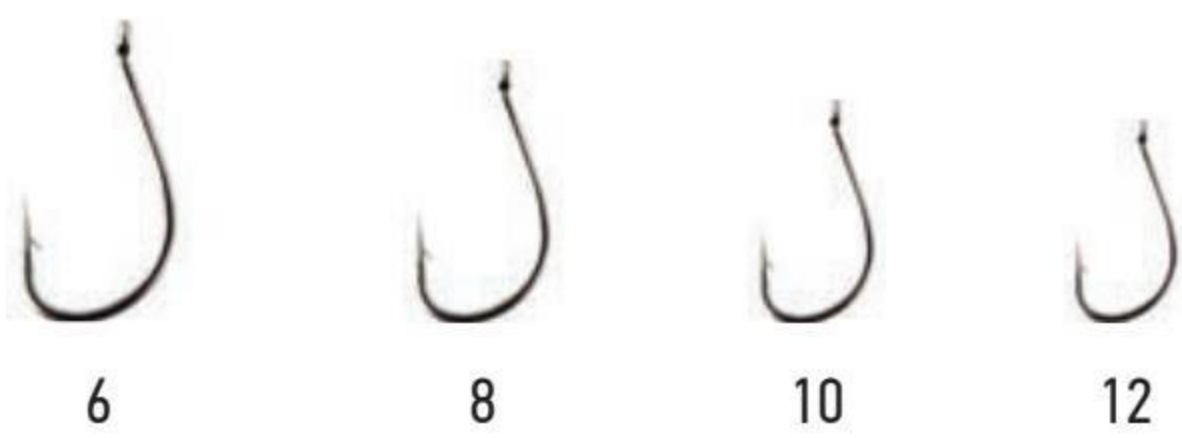

ITEM NO.	SIZE	Q-TY IN A PACK (PCS.)
CF205-006	6	10
CF205-008	8	10
CF205-010	10	10
CF205-012	12	10

### HOOKS COBRA FEEDER **CF201**

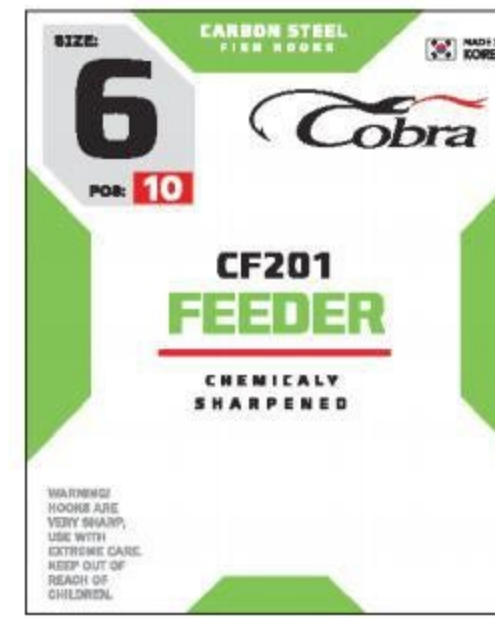

**Bait:** all kinds  
**Fish:** medium and large  
**Fishing type:** float and bottom  
**Color:** bronze  
**Hook type:** eyed

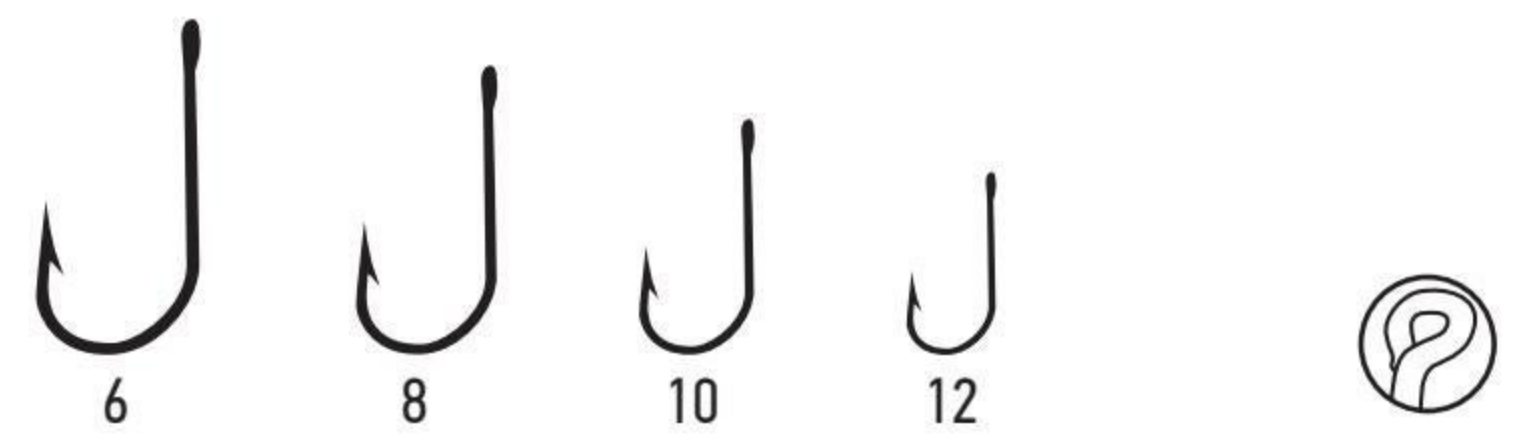

ITEM NO.	SIZE	Q-TY IN A PACK (PCS.)
CF201-***	006; 008; 010; 012	10

### HOOKS COBRA FEEDER **CF202**

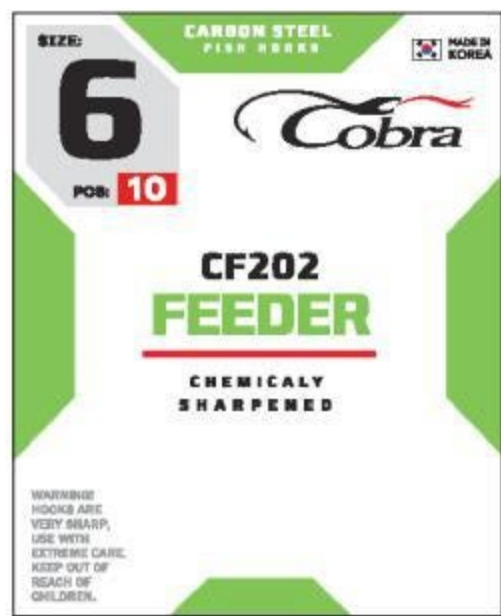

**Bait:** all kinds  
**Fish:** medium and large  
**Fishing type:** bottom  
**Color:** black nickel  
**Hook type:** eyed

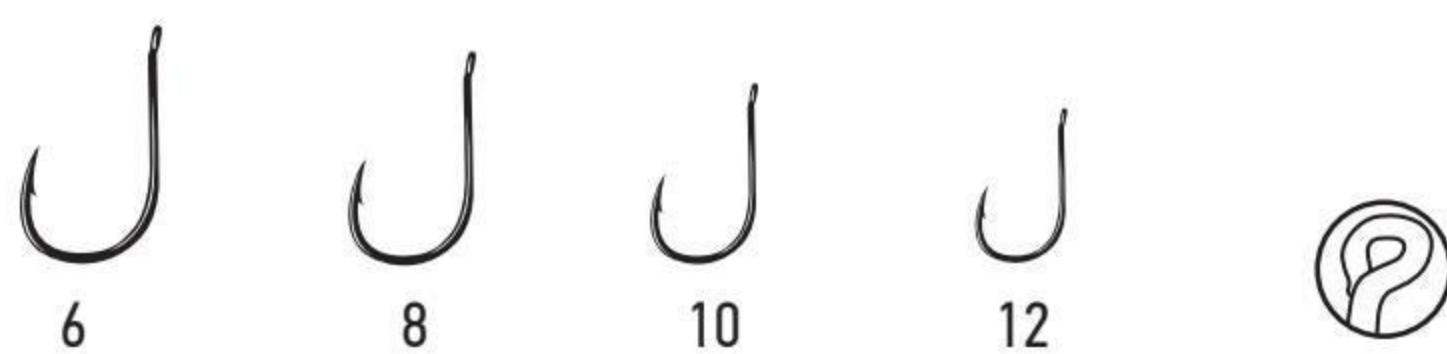

ITEM NO.	SIZE	Q-TY IN A PACK (PCS.)
CF202-***	006; 008; 010; 012	10

### HOOKS COBRA FEEDER **CF203**

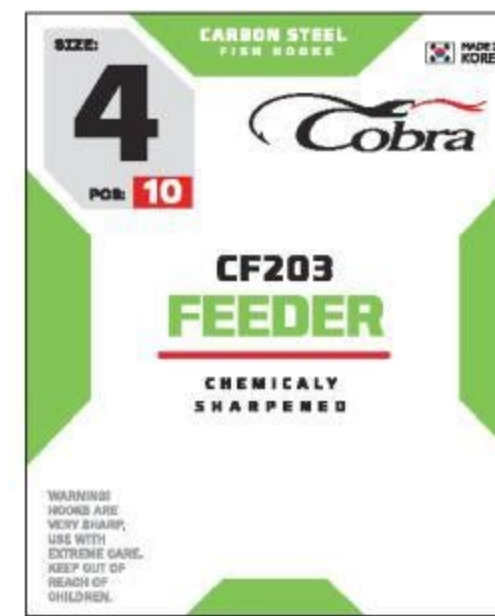

**Bait:** all kinds  
**Fish:** small, medium and large  
**Fishing type:** float and bottom  
**Color:** black nickel  
**Hook type:** eyed

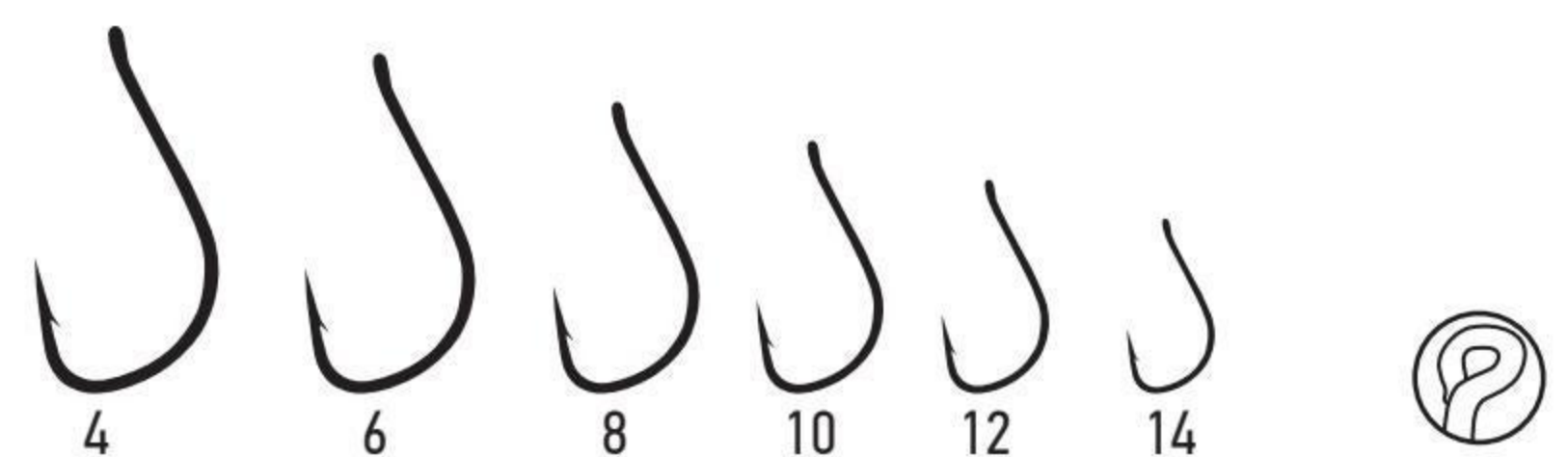

ITEM NO.	SIZE	Q-TY IN A PACK (PCS.)
CF203-***	004; 006; 008; 010; 012; 014	10



THE SIZE OF THE HOOKS DISPLAYED IN THE CATALOGUE CORRESPONDS TO THE ACTUAL HOOK SIZE

## SNELLED HOOKS COBRA **ALLROUND CNA102**



**Bait:** all kinds  
**Fish:** small and medium  
**Fishing type:** float and bottom  
**Color:** black nickel  
**Hook type:** spade end  
**Leader:** transparent, high strength

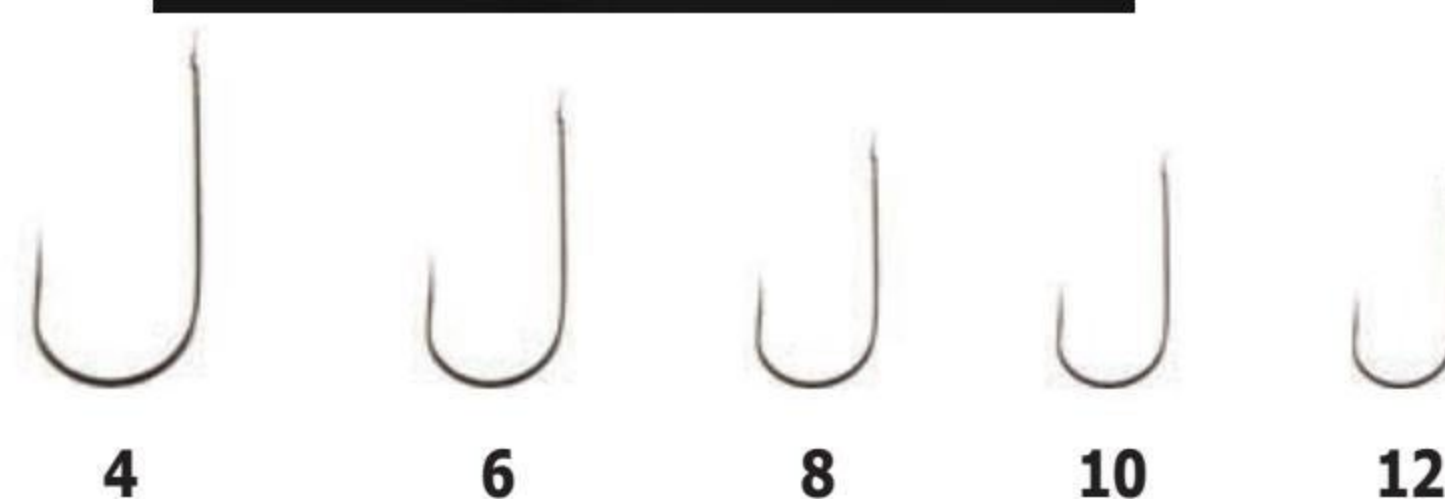

ITEM NO.	SIZE	LINE DIAMETER (MM)	LEASH LENGTH (CM)	Q-TY IN A PACK (PCS.)
CNA102-004	4	0,20	70	10
CNA102-006	6	0,18	70	10
CNA102-008	8	0,16	70	10
CNA102-010	10	0,14	70	10
CNA102-012	12	0,12	70	10

## SNELLED HOOKS COBRA **CARP CNC101**

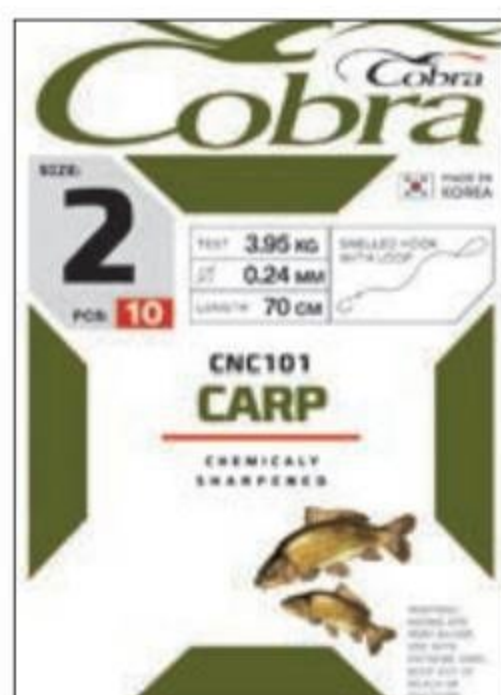

**Bait:** all kinds  
**Fish:** medium and large  
**Fishing type:** float and bottom  
**Color:** black nickel  
**Hook type:** spade end  
**Leader:** transparent, high strength

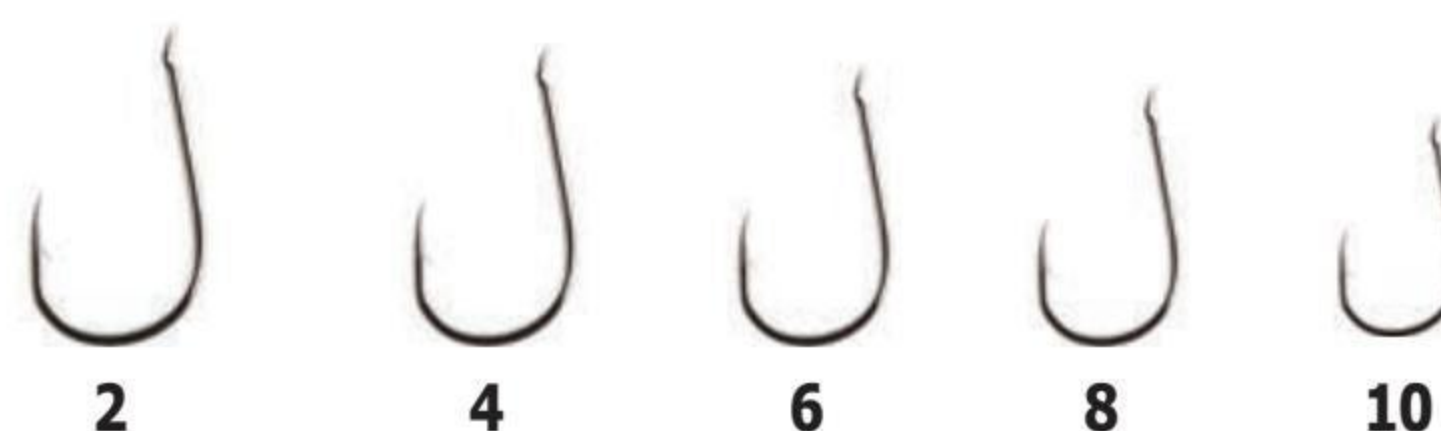

ITEM NO.	SIZE	LINE DIAMETER (MM)	LEASH LENGTH (CM)	Q-TY IN A PACK (PCS.)
CNC101-002	2	0,24	70	10
CNC101-004	4	0,20	70	10
CNC101-006	6	0,18	70	10
CNC101-008	8	0,16	70	10
CNC101-010	10	0,14	70	10

## SNELLED HOOKS COBRA **FEEDER CNF100**

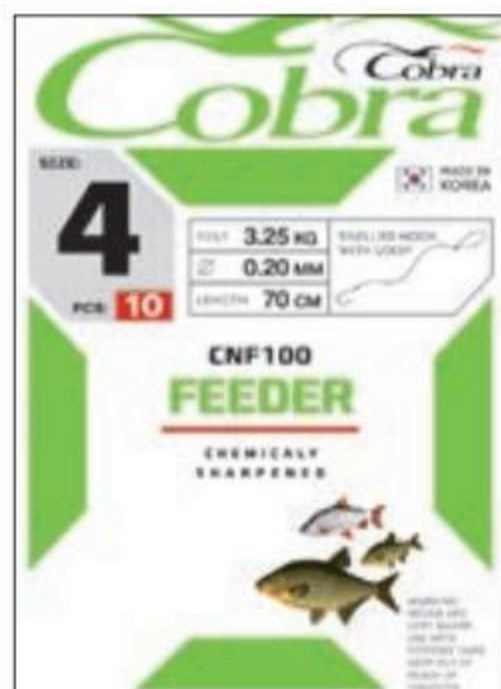

**Bait:** all kinds  
**Fish:** small, medium and large  
**Fishing type:** feeder  
**Color:** black nickel  
**Hook type:** spade end  
**Leader:** transparent, high strength

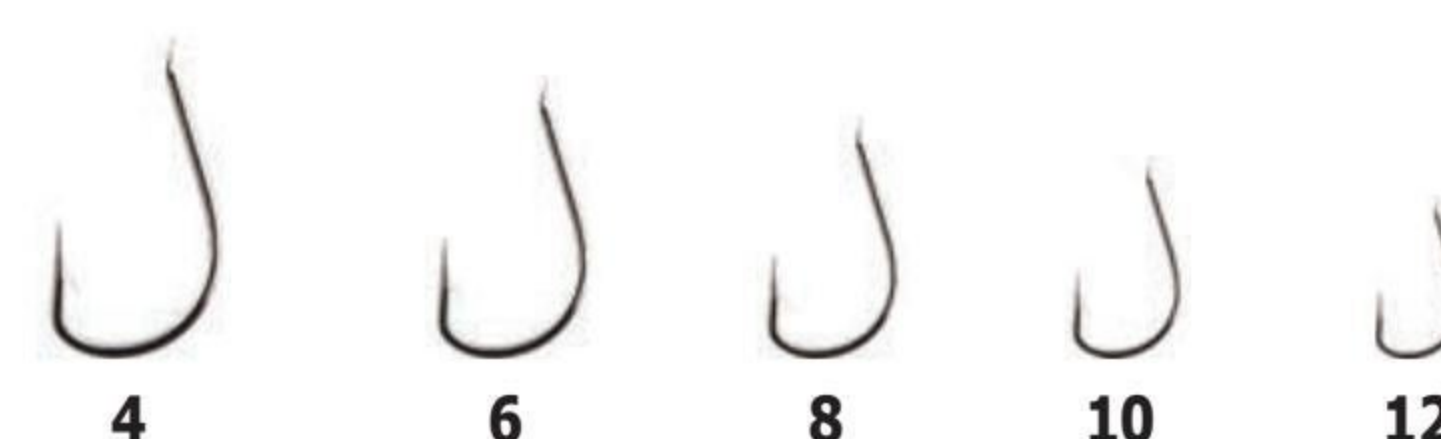

ITEM NO.	SIZE	LINE DIAMETER (MM)	LEASH LENGTH (CM)	Q-TY IN A PACK (PCS.)
CNF100-004	4	0,20	70	10
CNF100-006	6	0,18	70	10
CNF100-008	8	0,16	70	10
CNF100-010	10	0,14	70	10
CNF100-012	12	0,12	70	10

THE SIZE OF THE HOOKS DISPLAYED IN THE CATALOGUE CORRESPONDS TO THE ACTUAL HOOK SIZE



## \* NORFIN® ULTIMATE PROTECTION

### CLOTHING

NORFIN is a brand offering clothing and footwear, giving guarantee of comfort and modern look. Through the years **NORFIN** has accumulated experience, especially in production of clothing for fishing and angling. Our clothing is developed by professionals of clothing manufacturing, but with great involvement and advice from anglers, making sure that

the necessary attention is paid to all essential aspects. **NORFIN** uses the latest materials and designs to make you enjoy your fishing experience without any worries about weather conditions – hot or chilly, rain or sun – **NORFIN** will give you Ultimate Protection!

### LAYER SYSTEM

When you are fishing and it is probably the catch of your lifetime, we don't want even the smallest inconvenience to ruin it. That's why we make practical and functional clothing for anglers which will keep you warm in all conditions. Fishing can be a combination of active movement or long and patient waiting, so the clothing must be also universal or suitable for the activity. **NORFIN** clothing can be divided in layers with different functions – all this we call **NORFIN LAYER SYSTEM**.

Each layer of clothing serves its own special purpose.

1. Basic layer – draws moisture away from the body.
2. Warming layer – ensures warmth and insulation without hindering your movements.
3. Additional warming layer – keeps you warm when you don't move.
4. Protective layer – protects you from wind and the effects of weather conditions.

## MATERIALS AND TECHNOLOGIES



In comparison to the majority of materials used to manufacture outdoor wear, this modern multiple-layer fabric has improved breathability. Specially designed fibres not only retain body warmth, but also draw moisture to the outside. Your clothing breathes, which makes them extremely comfortable and pleasant to wear. The fabric wicks moisture off the body and prevents sweating, at the same time retaining all thermal insulating qualities of the fabric. The moisture is drawn out through the upper layers of fabric. Extra strong **NORTEX BREATHABLE** material is water-resistant and ensures the long life of the clothing made with it.



**WINDPROOF** – Material with P11 membrane protects you against wind, cold and rain, at the same time letting your body breathe as excess moisture is drawn out through the material.



**THERMO GUARD** – High quality, synthetic insulation made of polyester microfibers, which trap the warm air close to your body, providing you with warmth and doesn't absorb moisture. THERMO GUARD insulation doesn't cause allergic reactions.



**COTTON** – The main benefits of Cotton are its natural quality and high breathability. Cotton is also highly durable. It absorbs moisture perfectly, which can be very useful for a hot midday when you can refresh yourself by wetting your clothing with fresh water.



**HOLLOFIL** – High technology insulation with hollow fibers developed by company DuPont.



**NORFIN SILENT MATERIAL** – Specially designed to disguise your appearance, NORFIN SILENT MATERIAL fabrics are practically noiseless, ensuring great freedom of movement.



**NORFIN DRY** – The process implies wicking moisture from the body to the surface of the material in hot weather. The moisture quickly evaporates from the surface of material, thus refreshing the body and improving comfort.



**CONVERT ROLL** – sleeves and lower part of pants can be rolled up and fixed.

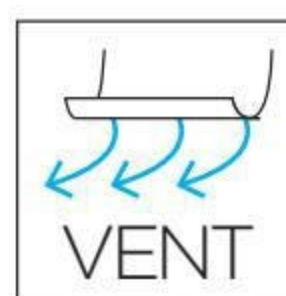

**NORFIN VENT** – Additional ventilation in the underarms and (or) back area.



**UV PROTECTION**  
Ultraviolet protection indicator.



**CONVERT ZIPPER** – sleeves and the lower part of pants are attached by a zipper.

**NORFLEECE** – material designed to ensure maximal comfort in cold - weather conditions. Its super - lightweight provides excellent mobility, and breathable, high quality insulating fabrics perfectly regulate your core temperature, reducing the possibility of overheating or freezing.



- NORFLEECE DRY**
- ▶ Best moisture management
  - ▶ Two layer material
  - ▶ Comfortable next to skin
  - ▶ Dries quickly



- NORFLEECE MICRO**
- ▶ High breathability
  - ▶ Comfortable feel
  - ▶ Detains body heat
  - ▶ Dries quickly

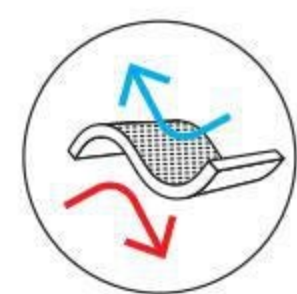

- NORFLEECE SHELL**
- ▶ Functional lightweight fabric
  - ▶ Excellent warmth management
  - ▶ 3 layer material
  - ▶ Provides wind resistance



- NORFLEECE STRETCH**
- ▶ 4 waystretch
  - ▶ Durable surface
  - ▶ High breathability
  - ▶ Dries quickly

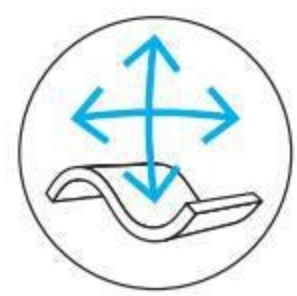

- NORFLEECE THERMO**
- ▶ High breathability
  - ▶ Comfortable feel
  - ▶ Detains body heat
  - ▶ Dries quickly

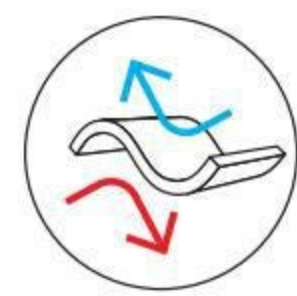

- NORFLEECE THERMO+**
- ▶ Detains body heat
  - ▶ Wind and cold resistant
  - ▶ Breathable
  - ▶ Comfortable feel

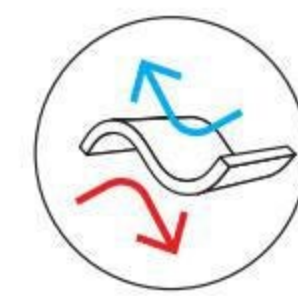

## FURNITURA



**YKK** is leader in zipper production, offering no-compromise quality. **YKK** zippers, which are made in Japan, can be found from the earth's oceans and into space, every environment known to man.

## TECHNICAL TERMS



**WATERPROOF** – Hydrostatic head rating



**BREATHABLE** – The ability of a fabric to allow moisture vapor to be transmitted through the material. The performance is measured in  $gr/m^2/24h$

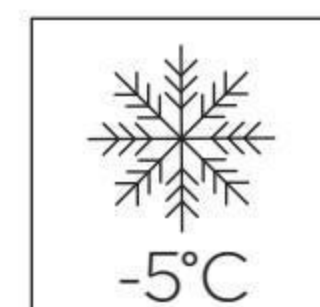

**TEMPERATURE** – Comfort temperature rating



## DEMI-SEASON SUIT NORFIN REBEL PRO

MULTI-SEASON SUIT NORFIN REBEL PRO – made of best materials in industry will fit the most demanding fisherman. REBEL PRO is made of Toray Dermizax 2-layer membrane material with high hydrostatic and breathability ratings. High-loft and light 3M Thinsulate insulation is used to keep you warm in sub-zero conditions in autumn and spring. Created for fishing in harshest weather. Toray material ensures extreme waterproofness. Thinsulate high-loft insulation ensures comfortable fishing.

### JACKET:

- ▶ Fully taped seams
- ▶ Two-way open-end YKK zipper with protective flap
- ▶ Extra ventilation in armpits
- ▶ Two-way adjustable hood
- ▶ Dual draw-cord adjustable bottom hem
- ▶ Handy inside and outside pockets
- ▶ Elastic, double cuffs
- ▶ Inside pocket with cloth for cleaning glasses

### BIB AND BRACE:

- ▶ Length-adjustable suspenders
- ▶ Two-way open-end YKK zipper with protective flap
- ▶ Two side pockets
- ▶ Two cargo pockets
- ▶ Zipper on legs' bottoms



WATERPROOFING  
**20000 MM**

MATERIAL  
**TORAY DERMIZAX**

BREATHABILITY  
**10000 G/M<sup>2</sup>/24 HOUR**

INSULATION  
**3D THINSULATE 100 G**

ITEM NO.	SIZE (****)	DESCRIPTION
595001-**	S	jacket and trousers
595002-**	M	jacket and trousers
595003-**	L	jacket and trousers
595004-**	XL	jacket and trousers
595005-**	XXL	jacket and trousers
595006-**	XXXL	jacket and trousers



**DEMI-SEASON SUIT  
NORFIN BOAT**

Versatile fishing gear for men that will keep out wind and rain when you are fishing. Breathable and durable material NORTEX BREATHABLE and fully taped seams keeps you comfortable and protects from elements. Two spacious cargo pockets provide more than enough storage for all necessary things. Ensures warmth and comfort at temperatures as low as -5°C

**JACKET**

- ▶ Durable membrane material
- ▶ Modern and multifunctional design
- ▶ Deep two-way adjustable zip – off hood
- ▶ Two plastic rings for fishing accessories
- ▶ Two spacious chest pockets with flaps
- ▶ Two side pockets with zippers
- ▶ Inside pocket for phone and accessories
- ▶ Adjustable sleeve cuffs with Velcro
- ▶ All seams fully taped
- ▶ Extended lower back part
- ▶ Drawstring to tighten the jacket's lower part

**PANTS**

- ▶ Membrane material
- ▶ Two side pockets with zippers
- ▶ All seams are accurately taped
- ▶ Adjustable, removable suspenders
- ▶ Adjustment straps with Velcro for upper part volume
- ▶ Zipped, adjustable leg bottom



WATERPROOFING  
**10 000 MM**

MATERIAL  
**NORTEX BREATHABLE**

BREATHABILITY  
**6000 G/M<sup>2</sup>/24 HOUR**

INSULATION  
**THERMO GUARD**

ITEM NO.	SIZE (****)	DESCRIPTION
677001-****	S	jacket and trousers
677002-****	M	jacket and trousers
677003-****	L	jacket and trousers
677004-****	XL	jacket and trousers
677005-****	XXL	jacket and trousers
677006-****	XXXL	jacket and trousers

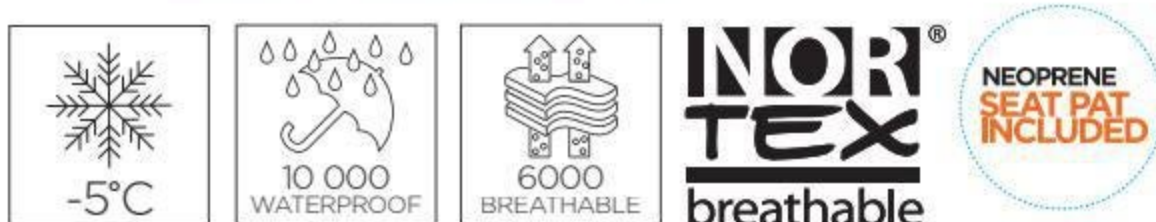



## DEMI-SEASON SUIT NORFIN PRO DRY 3

Designed especially for fisherman who love to be outside despite extreme weather conditions, this rain suit provides excellent functionality and moisture control. The 3 layer material is durable enough to retain its water resistance and breathability over a long period of time. High Quality materials, advanced construction techniques and many functional features make NORFIN PRO DRY 3 the perfect choice for use in rough weather.

3 Layer waterproof, windproof, breathable material

High rise trousers for more protection

Versatile pockets for fishing gear

### JACKET:

- ▶ Three – layer membrane material
- ▶ Modern and multifunctional design
- ▶ Deep two way adjustable zip –off hood
- ▶ Two plastic rings for fishing accessories
- ▶ Two chest pockets with waterproof zippers
- ▶ Two spacious chest pockets with flaps
- ▶ Two side pockets with waterproof zippers
- ▶ Inside pocket for phone and accessories
- ▶ Adjustable sleeve cuffs with Velcro
- ▶ All seams accurately taped
- ▶ Drawstring to tighten the jacket's lower part

### PANTS:

- ▶ Three – layer membrane material
- ▶ Two side pockets with waterproof zippers
- ▶ All seams are accurately taped
- ▶ Adjustable, removable suspenders
- ▶ Adjustment straps with velcros for upper part volume
- ▶ Reinforced knee and backside area
- ▶ Zipped, adjustable leg bottom



LIGHT AND DURABLE



WATERPROOFING  
**15000 MM**

MATERIAL  
**80% POLYESTER  
20% PU MEMBRANE**

BREATHABILITY  
**8000 G/M<sup>2</sup>/24 HOUR**

ITEM NO.	SIZE (****)	DESCRIPTION
514401-S	S	jacket and trousers
514402-M	M	jacket and trousers
514403-L	L	jacket and trousers
514404-XL	XL	jacket and trousers
514405-XXL	XXL	jacket and trousers
514406-XXXL	XXXL	jacket and trousers



# NOREIN® Pro Dry 3 Camo

## DEMI-SEASON SUIT NORFIN PRO DRY 3 CAMO

Designed especially for fisherman who love to be outside despite extreme weather conditions, this rain suit provides excellent functionality and moisture control. The 3layer material is durable enough to retain its water resistance and breathability over a long period of time. High Quality materials, advanced construction techniques and many functional features make NORFIN PRO DRY 3 the perfect choice for use in rough weather.

3 Layer waterproof, windproof, breathable material

High rise trousers for more protection

Versatile pockets for fishing gear

### JACKET:

- ▶ Three – layer membrane material
- ▶ Modern and multifunctional design
- ▶ Deep two way adjustable zip –off hood
- ▶ Two plastic rings for fishing accessories
- ▶ Two chest pockets with waterproof zippers
- ▶ Two spacious chest pockets with flaps
- ▶ Two side pockets with waterproof zippers
- ▶ Inside pocket for phone and accessories
- ▶ Adjustable sleeve cuffs with Velcro
- ▶ All seams accurately taped
- ▶ Drawstring to tighten the jacket's lower part

### PANTS:

- ▶ Three – layer membrane material
- ▶ Two side pockets with waterproof zippers
- ▶ All seams are accurately taped
- ▶ Adjustable, removable suspenders
- ▶ Adjustment straps with velcros for upper part volume
- ▶ Reinforced knee and backside area
- ▶ Zipped, adjustable leg bottom



WATERPROOFING  
**15000 MM**

MATERIAL  
**80% POLYESTER  
20% PU MEMBRANE**

BREATHABILITY  
**8000 G/M<sup>2</sup>/24 HOUR**

ITEM NO.	SIZE (****)	DESCRIPTION
514501-S	S	jacket and trousers
514502-M	M	jacket and trousers
514503-L	L	jacket and trousers
514504-XL	XL	jacket and trousers
514505-XXL	XXL	jacket and trousers
514506-XXXL	XXXL	jacket and trousers





## RAIN SUIT NORFIN ALPHA

RAIN SUIT NORFIN ALPHA - versatile fishing gear that will keep away wind and rain when you are fishing. Breathable and durable material Nortex Breathable and fully taped seams will keep you comfortable and protected from rough weather. Two spacious cargo pockets provide more than enough storage for all necessary things.

### JACKET:

- ▶ Durable membrane material
- ▶ Modern and multifunctional design
- ▶ Deep two-way adjustable zip – off hood
- ▶ Two plastic rings for fishing accessories
- ▶ Two spacious chest pockets with flaps
- ▶ Two side pockets with zippers
- ▶ Inside pocket for phone and accessories
- ▶ Adjustable sleeve cuffs with Velcro
- ▶ All seams fully taped
- ▶ Extended lower back part
- ▶ Drawstring to tighten the jacket's lower part

### PANTS:

- ▶ Membrane material
- ▶ Two side pockets with zippers
- ▶ All seams are accurately taped



WATERPROOFING  
**10 000 MM**

MATERIAL  
**NORTEX BREATHABLE**

BREATHABILITY  
**6000 G/M<sup>2</sup>/24 HOUR**

INSULATION  
**80% POLYESTER  
20% PU MEMBRANE**

ITEM NO.	SIZE (****)	DESCRIPTION
646001-****	S	jacket and trousers
646002-****	M	jacket and trousers
646003-****	L	jacket and trousers
646004-****	XL	jacket and trousers
646005-****	XXL	jacket and trousers
646006-****	XXXL	jacket and trousers





**NEW**

## RAIN SUIT NORFIN ALPHA NAVY BLUE

RAIN SUIT NORFIN ALPHA NAVY BLUE – versatile fishing gear that will keep away wind and rain when you are fishing. Breathable and durable material Nortex Breathable and fully taped seams will keep you comfortable and protected from rough weather. Two spacious cargo pockets provide more than enough storage for all necessary things.

**JACKET:**

- ▶ Durable membrane material
- ▶ Modern and multifunctional design
- ▶ Deep two-way adjustable zip – off hood
- ▶ Two plastic rings for fishing accessories
- ▶ Two spacious chest pockets with flaps
- ▶ Two side pockets with zippers
- ▶ Inside pocket for phone and accessories
- ▶ Adjustable sleeve cuffs with Velcro
- ▶ All seams fully taped
- ▶ Extended lower back part
- ▶ Drawstring to tighten the jacket's lower part

**PANTS:**

- ▶ Membrane material
- ▶ Two side pockets with zippers
- ▶ All seams are accurately taped
- ▶ Adjustable, removable suspenders
- ▶ Adjustment straps with Velcros for upper part volume
- ▶ Reinforced knee and backside area
- ▶ Zipped, adjustable leg bottom



WATERPROOFING  
**10 000 MM**

MATERIAL  
**NORTEX BREATHABLE**

BREATHABILITY  
**6000 G/M<sup>2</sup>/24 HOUR**

INSULATION  
**80% NEILON  
20% PU MEMBRANE**

ITEM NO.	SIZE (****)	DESCRIPTION	COLOR
646101-****	S	jacket and bib and brace	navy blue
646102-****	M	jacket and bib and brace	navy blue
646103-****	L	jacket and bib and brace	navy blue
646104-****	XL	jacket and bib and brace	navy blue
646105-****	XXL	jacket and bib and brace	navy blue
646106-****	XXXL	jacket and bib and brace	navy blue





**NEW**

## RAIN SUIT NORFIN MIRAGE

Compact rain suit made of durable membrane material, NORTEX BREATHABLE, will ensure comfort and protection from wind and rain, when the weather turns bad. All seams of the breathable membrane are accurately taped. The pants feature elastic waist for additional comfort and perfect fit.

### JACKET

- Deep, two way adjustable hood
- Main front zipper with protective flap
- Chest pocket with waterproof zipper
- Two spacious side pockets with waterproof zippers
- Inside pocket with zipper for phone and documents
- Adjustable sleeve cuffs with Velcros
- Mesh lining
- Adjustable lower part
- All seams taped

### PANTS

- Elastic, adjustable waist
- Two side pockets with protective flaps
- Zipped, adjustable leg bottom
- All seams are accurately taped



WATERPROOFING  
**9 000 MM**

MATERIAL  
**NORTEX BREATHABLE**

BREATHABILITY  
**6 000 G/M<sup>2</sup>/24 HOUR**



ITEM NO.	SIZE (****)	DESCRIPTION
637001-****	S	jacket and bib and brace
637002-****	M	jacket and bib and brace
637003-****	L	jacket and bib and brace
637004-****	XL	jacket and bib and brace
637005-****	XXL	jacket and bib and brace
637006-****	XXXL	jacket and bib and brace



**NEW**

## RAIN SUIT **NORFIN THUNDER**

Waterproof, light and compact rain suit, designed for fishing and many other outdoor activities. Made from breathable and waterproof Nor-Tex Breathable material.

### JACKET

- Adjustable hood
- Single-hand adjustable hem with draw cord
- Two side pockets
- Chest pocket
- Nylon lining

### TROUSERS

- Articulated knees
- Two side pockets
- Elastic waist
- Nylon lining



WATERPROOFING  
**8 000 MM**

MATERIAL  
**NORTEX BREATHABLE**

BREATHABILITY  
**5 000/M<sup>2</sup>/24 HOUR**

ITEM NO.	SIZE (****)	DESCRIPTION
623001-****	S	jacket and bib and brace
623002-****	M	jacket and bib and brace
623003-****	L	jacket and bib and brace
623004-****	XL	jacket and bib and brace
623005-****	XXL	jacket and bib and brace
623006-****	XXXL	jacket and bib and brace





**NEW**

## DEMI-SEASON SUIT NORFIN FEEDER THERMO

DEMI-SEASON SUIT NORFIN FEEDER THERMO – specially designed and reinforced in key areas to ensure that you will be dry and comfortable while sitting for a long time. Modern and light HOLLOWFIL insulation is used to keep you warm in spring and autumn chilly weather. Designed to keep you warm at temperatures as low as  $-10^{\circ}\text{C}$ . Specially designed for fishing while sitting. Reinforced material on areas most exposed to weather.

### JACKET:

- ▶ Glued seams
- ▶ Storm flaps over the main zips and pockets to protect you from the elements
- ▶ Zip-off hood
- ▶ Two way adjustable hood
- ▶ Drawstring to tighten the jacket's lower part
- ▶ Handy inside and outside pockets
- ▶ Reflective security patches

### BIB AND BRACE:

- ▶ Length-adjustable, wide shoulder straps
- ▶ Wide opening legs with Velcro adjustment
- ▶ Storm flap over front zipper
- ▶ Reinforced knee and seat panels
- ▶ Elastic, adjustable waist for extra comfort



WATERPROOFING  
**8000 MM**

MATERIAL  
**NORTEX BREATHABLE**

BREATHABILITY  
**6000 G/M<sup>2</sup>/24 HOUR**

**HOLLOFIL** **YKK**  
Little Parts. Big Difference.®

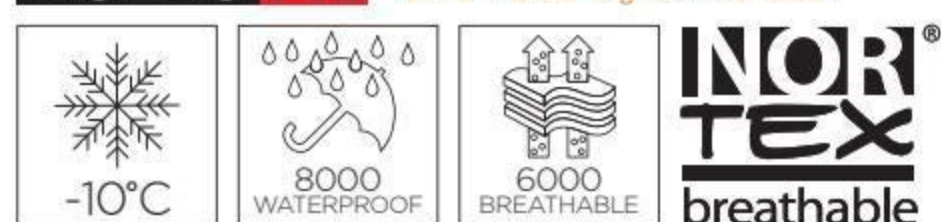

ITEM NO.	SIZE (****)	DESCRIPTION
738201-***	S	jacket and bib and brace
738202-***	M	jacket and bib and brace
738203-***	L	jacket and bib and brace
738204-***	XL	jacket and bib and brace
738205-***	XXL	jacket and bib and brace
738206-***	XXXL	jacket and bib and brace

**DEMI-SEASON SUIT FEEDER CONCEPT STORM**

Waterproof, all season rain suit, designed for fishing and many other outdoor activities. Provides protection and mobility during strong precipitation and due to the characteristics of the material and the dark color it is very easy to be cleaned – you can simply rinse the mud off.

**JACKET:**

- ▶ Waterproof front zipper
- ▶ Adjustable hood
- ▶ Single hand adjustable hem with drawcord
- ▶ Two side pockets
- ▶ Chest pocket
- ▶ Nylon lining

**TROUSERS:**

- ▶ Articulated knees
- ▶ Elastic waistband
- ▶ Two side pockets with zippers
- ▶ Adjustable trousers end
- ▶ Nylon lining



WATERPROOFING <b>8000 MM</b>	MATERIAL <b>NORTEX BREATHABLE</b>
BREATHABILITY <b>5000 G/M<sup>2</sup>/24 HOUR</b>	

ITEM NO.	SIZE (****)	DESCRIPTION
FC920001-***	S	jacket and bib and brace
FC920002-***	M	jacket and bib and brace
FC920003-***	L	jacket and bib and brace
FC920004-***	XL	jacket and bib and brace
FC920005-***	XXL	jacket and bib and brace
FC920006-***	XXXL	jacket and bib and brace



## DEMI-SEASON SUIT NORFIN RAIN

DEMI-SEASON SUIT NORFIN RAIN - durable lightweight suit will protect you from wind and precipitation during the strongest rainfalls. All seams of the jacket and pants are accurately glued, providing additional durability. The trousers feature an elastic waistband and two pockets with flaps. This lightweight suit is very compact and takes a minimum of space, when not used.

### JACKET:

- ▶ Light, waterproof material
- ▶ Comfortable hood
- ▶ Two side pockets
- ▶ Elastic sleeve cuffs

### PANTS:

- ▶ Elastic waist
- ▶ Two side pockets with flaps

MATERIAL  
**POLYESTER + PVC COATING**

ITEM NO.	SIZE (****)	DESCRIPTION
508002-*	M	jacket and trousers
508003-*	L	jacket and trousers
508004-**	XL	jacket and trousers
508005-***	XXL	jacket and trousers
508006-****	XXXL	jacket and trousers



## JACKET NORFIN RIVER

JACKET NORFIN RIVER – durable and comfortable jacket specially designed for enthusiasts of different outdoor activities, including fishing, trekking etc. All seams are taped. The longer back part and the adjustable lower part ensure extra protection against wind and rain. The jacket also features a deep, adjustable hood and it is very compact.

- ▶ Membrane material
- ▶ Adjustable waist
- ▶ Two chest pockets with flaps
- ▶ Two side pockets with zippers
- ▶ Deep, adjustable hood
- ▶ Compact and lightweight
- ▶ Adjustable sleeve cuffs
- ▶ All seams glued
- ▶ Inside pocket for phone
- ▶ Extended lower back part

WATERPROOFING <b>8000 MM</b>	MATERIAL <b>NORTEX</b>
BREATHABILITY <b>5000 G/M<sup>2</sup>/24 HOUR</b>	<b>BREATHABLE</b>

ITEM NO.	SIZE (****)	DESCRIPTION
513101-***	S	jacket
513102-***	M	jacket
513103-***	L	jacket
513104-***	XL	jacket
513105-***	XXL	jacket





## PANTS NORFIN SIGMA

PANTS NORFIN SIGMA – Experienced anglers and outdoor enthusiasts will appreciate these durable and functional trousers. Reinforced waterproof knee and seat area will protect from moisture while sitting or kneeling.

- ▶ Durable Nylon Taslon Ripstop material
- ▶ Two side pockets
- ▶ Two cargo pockets
- ▶ Articulated knees
- ▶ Elasticated waist with belt straps

### MATERIAL

**100% NYLON TASLON RIPSTOP**

### REINFORCMENT

**NYLON TASLON OXFORD WITH PU COATING**

ITEM NO.	SIZE (****)	DESCRIPTION
663001-***	S	pants
663002-***	M	pants
663003-***	L	pants
663004-***	XL	pants
663005-***	XXL	pants



## PANTS NORFIN RIVER

PANTS NORFIN RIVER benefit of an enlarged size, which makes it easy to wear them right on your casual pants. Experienced fishing and outdoor enthusiasts will appreciate the highly breathable and waterproof qualities of NORTEX BREATHABLE material which also aims to draw sweat away from the body by letting it evaporate. The 100% waterproof pants also have two functional side pockets with flaps and waterproof zippers.

- ▶ Membrane material
- ▶ Two waterproof side pockets with waterproof zippers on the front
- ▶ All seams are accurately glued
- ▶ Adjustable, removable suspenders
- ▶ Zip-fasteners on trouser legs

### WATERPROOFING

**8000 MM**

### BREATHABILITY

**5000 G/M<sup>2</sup>/24 HOUR**

### MATERIAL

**NORTEX  
BREATHABLE**

ITEM NO.	SIZE (****)	DESCRIPTION
521102-***	M	pants
521103-***	L	pants
521104-***	XL	pants
521105-***	XXL	pants



**NORTEX**  
breathable



## PANTS NORFIN SIGMA CANVAS CAMO

Experienced anglers and outdoor enthusiasts will appreciate these durable and functional trousers. Breathable and durable Cotton Canvas material will ensure comfort in cool summer mornings.

- ▶ Durable Cotton Canvas material
- ▶ Two side pockets
- ▶ Two cargo pockets
- ▶ Articulated knees

MATERIAL  
**100% COTTON CANVAS**

ITEM NO.	SIZE (****)	DESCRIPTION
667101-***	S	pants
667102-***	M	pants
667103-***	L	pants
667104-***	XL	pants
667105-***	XXL	pants
667106-***	XXXL	pants



## PANTS NORFIN SIGMA CANVAS

Experienced anglers and outdoor enthusiasts will appreciate these durable and functional trousers. Breathable and durable Cotton Canvas material will ensure comfort in cool summer mornings.

- ▶ Durable Cotton Canvas material
- ▶ Two side pockets
- ▶ Two cargo pockets
- ▶ Articulated knees

MATERIAL  
**100% COTTON CANVAS**

ITEM NO.	SIZE (****)	DESCRIPTION
667002-***	M	pants
667003-***	L	pants
667004-***	XL	pants
667005-***	XXL	pants



## BASEBALL CAP NORFIN DESERT

Baseball cap with brim and additional neck protection against the sun.



ITEM NO.	DESCRIPTION
7451-03L	100% Nylon
7451-04XL	100% Nylon

## BASEBALL CAP NORFIN STRATUS

Mosquito protection.



ITEM NO.	DESCRIPTION
7491-03L	100% Nylon
7491-04XL	100% Nylon

## HAT NORFIN BOONIE

Mosquito protection.



ITEM NO.	DESCRIPTION
7461-03L	100% Nylon
7461-04XL	100% Nylon

## HAT NORFIN VENT



ITEM NO.	DESCRIPTION
7471-03L	100% Nylon
7471-04XL	100% Nylon

## GLOVES NORFIN GRIP 3CUT

Professional 3 cut fishing gloves with a modern design, made of high quality neoprene, perfectly suitable for warm and cool weather. The gloves will provide safety and comfortable warmth for your hands. They securely fix on the wrist with Velcro textile fasteners.



ITEM NO.	SIZE	DESCRIPTION
703073-03L	L	35% neoprene, 65% polyester
703073-04XL	XL	35% neoprene, 65% polyester

## GLOVES NORFIN CONTROL NEOPRENE

Made of high quality neoprene, perfectly suitable for cool weather. The gloves will provide safety and comfortable warmth for your hands. They securely fix on the wrist with Velcro textile fasteners.



ITEM NO.	SIZE	DESCRIPTION
703074-03L	L	100% neoprene
703074-04XL	XL	100% neoprene

## GLOVES NORFIN ROACH 5 CUT NEW

Professional 5 cut fishing gloves. Protects and keeps comfortable palms while fishing. 4-way stretch material with ultra-grip material on palms.

- Very durable
- Comfortable, close fit
- High quality stitching
- Anatomic shape



ITEM NO.	SIZE	DESCRIPTION
703072-03M	M	35% neoprene, 65% polyester
703072-03L	L	35% neoprene, 65% polyester
703072-03XL	XL	35% neoprene, 65% polyester

**NEW**

## BOOTS NORFIN NTX RAPID LOW

Low trekking shoes, comfortable, lightweight, and durable. Shoes are as comfortable as possible for fishing, tourism, and for daily wear in the city. Suitable for warm and mid-season wear. Deep tread outsole provides stability.

- The upper part of the shoes is polyester, plus a «breathable» membrane material
- Strong laces
- Lightweight and flexible outsole
- Deep tread for better grip

**Material:**

**Upper part:** POLYESTER+ PU membrane

**Outsole:** EVA + PU



ITEM NO.	SIZE	COLOUR
15804-**	40	black
15804-**	41	black
15804-**	42	black
15804-**	43	black
15804-**	44	black
15804-**	45	black
15804-**	46	black



**NEW**

## SANDALS NORFIN MIRAGE

Lightweight trekking sandals with the airiness of a sandal and the toe protection of a shoe. The high quality sole provides excellent traction, and the washable webbing upper is ready for hiking, walking, and all your adventures, in and out of the water.

- Durable, comfortable materials
- Adjustable, durable straps
- EVA injection sole
- Comfortable ActivLight insole

**Materials:**

Upper part: Polyester

Outsole: EVA, PU



ITEM NO.	SIZE	COLOUR
15842-**	40	gray
15842-**	41	gray
15842-**	42	gray
15842-**	43	gray
15842-**	44	gray
15842-**	45	gray
15842-**	46	gray



## SANDALS NORFIN JOURNEY SN

Lightweight trekking sandals with the airiness of a sandal and the toe protection of a shoe. The high quality sole provides excellent traction, and the washable webbing upper is ready for hiking, walking, and all your adventures, in and out of the water.

**Materials:**

Upper part: **PU, Polyester**

Outsole: **EVA, Rubber**

- ▶ Durable, comfortable materials
- ▶ Adjustable back
- ▶ Elastic drawstrings

ITEM NO.	SIZE	COLOUR
15813-***	40	Sand
15813-***	41	Sand
15813-***	42	Sand
15813-***	43	Sand
15813-***	44	Sand
15813-***	45	Sand
15813-**	46	Sand



## BOOT NORFIN NTX ALPHA

**NEW**

Lightweight hiking boot, ideal for three-season use spring-summer-autumn. The two-component sole PU with EVA injection guarantees maximum comfort, yet it is abrasion-resistant enough to be suitable for light hiking trips as well as fishing and everyday use. Nor-Tex breathable material ensures waterproofness and breathability for different weather conditions.

- Middle height
- Durable, synthetic laces
- PU sole provides good grip and durability
- Light and comfortable insole ActiveLight

**Material:**

Upper: Polyester fabric; Synthetic inserts

Lining: Waterproof membrane

Sole: PU+EVA



ITEM NO.	SIZE	COLOUR
15821-**-	40	black/gray
15821-**-	41	black/gray
15821-**-	42	black/gray
15821-**-	43	black/gray
15821-**-	44	black/gray
15821-**-	45	black/gray
15821-**-	46	black/gray

## BOOTS NORFIN NTX ROCK

The cushioning and fit of the Ortholite® insoles provide maximum comfort. Ortholite® open-cell PU foam is very breathable and keeps the foot cooler. This unique structure creates a moisture management system, helping to move moisture away from the foot to provide a cooler, drier, healthier shoe environment.

**Upper:** Waterproof full grain leather 1,6/1,8 mm

**Lining:** Waterproof membrane

**Insole:** Pe

**Outsole:** Injected expanded PU midsole and solid PU

**Made in:** EU



ITEM NO.	SIZE	COLOUR
15801-41	41	Brown DAKAR MAROONE
15801-42	42	Brown DAKAR MAROONE
15801-43	43	Brown DAKAR MAROONE
15801-44	44	Brown DAKAR MAROONE
15801-45	45	Brown DAKAR MAROONE

## BOOTS NORFIN NTX LIGHT TREK LOW

The **NORFIN Ntx LIGHT TREK LOW** is a very lightweight shoe, ideal for three-season use spring-summer-autumn.

The cushioning and fit of the Ortholite® insoles provide maximum comfort.

Ortholite® open-cell PU foam is very breathable and keeps the foot cooler.

This unique structure creates a moisture management system, helping to

move moisture away from the foot to provide a cooler, drier, healthier shoe

environment.

**Upper:** Waterproof suede 1,6/1,8 mm Polyester fabric, Synthetic inserts

**Lining:** Waterproof membrane

**Insole:** Pe

**Outsole:** Injected expanded PU midsole and solid PU outsole

**Made in:** EU



ITEM NO.	SIZE	COLOUR
15802-41	41	GRAY/ BLACK
15802-42	42	GRAY/ BLACK
15802-43	43	GRAY/ BLACK
15802-44	44	GRAY/ BLACK
15802-45	45	GRAY/ BLACK
15802-46	46	GRAY/ BLACK

## WADERS NORFIN

For wade fishing, you will need to dress accordingly – wear waders. With waders, you can fish almost anywhere – near the edge of water plants and in clear water. All models are offered in a set with boots.



**NEW**

### WADERS WITH BOOTS NORFIN PILOT BOOTFOOT

Built from a 4-layer polyester material that offers an optimum balance between durability and breathability. Big external pocket with moisture proof zipper is ideal for bigger tackle box. Inside pocket will keep you most valuable things dry and safe. Rubber boots with neoprene lining for comfort and warmth. Includes waterproof phone case and synthetic carry bag.

- 4 – Layer, high quality material
- Less seams construction
- Rubber boots with neoprene lining
- Elastic, adjustable suspenders
- Adjustable belt
- Outside chest pocket with waterproof zipper
- Inside, zippered storage pocket
- Carry bag



WATERPROOFING  
**18 000 MM**

MATERIAL  
**NORTEX BREATHABLE**

BREATHABILITY  
**6 000 G/M<sup>2</sup>/24 HOUR**

ITEM NO.	SIZE (****)	MATERIAL
82231-****	42-M	NORTEX BREATHABLE
82231-****	43-M	NORTEX BREATHABLE
82231-****	44-L	NORTEX BREATHABLE
82231-****	44-XL	NORTEX BREATHABLE
82231-****	45-XL	NORTEX BREATHABLE
82231-****	46-XXL	NORTEX BREATHABLE



**WADERS NORFIN PILOT STOCKINGFOOD**

Built from a 4-layer polyester material that offers an optimum balance between durability and breathability. Big external pocket with moisture proof zipper is ideal for bigger tackle box. Inside pocket will keep you most valuable things dry and safe. Ergonomic sock made from durable, elastic neoprene with gravel guard. Includes waterproof phone case and synthetic carry bag.

- 4 – Layer, high quality material
- Les seams construction
- Ergonomic neoprene sock
- Gravel guard
- Elastic, adjustable suspenders
- Adjustable belt
- Outside chest pocket with waterproof zipper
- Inside, zippered storage pocket
- Carry bag

Waterproofing: 18 000 mm  
Breathability: 6 000 g/m<sup>2</sup>/24 h



<p>WATERPROOFING <b>18 000 MM</b></p>	<p>MATERIAL <b>NORTEX BREATHABLE</b></p>
<p>BREATHABILITY <b>6 000 G/M<sup>2</sup>/24 HOUR</b></p>	

ITEM NO.	SIZE (****)	MATERIAL
83321-****	01S	NORTEX BREATHABLE
83321-****	02M	NORTEX BREATHABLE
83321-****	03L	NORTEX BREATHABLE
83321-****	03L-L	NORTEX BREATHABLE
83321-****	03L-S	NORTEX BREATHABLE
83321-****	04XL	NORTEX BREATHABLE
83321-****	05XXL	NORTEX BREATHABLE



## WADING BOOTS NORFIN CLIFF

- Comfortable, lightweight boots
- Durable synthetic leather and textile material
- Light and elastic sole
- Close fit for better support

**Material:**

**Upper part:** 90% POLYESTER, 10% PVC

**Sole:** RUBBER



ITEM NO.	SIZE (**)	MATERIAL
71250-41	41	90% POLYESTER, 10% PVC, RUBBER
71250-42	42	90% POLYESTER, 10% PVC, RUBBER
71250-43	43	90% POLYESTER, 10% PVC, RUBBER
71250-44	44	90% POLYESTER, 10% PVC, RUBBER
71250-45	45	90% POLYESTER, 10% PVC, RUBBER
71250-46	46	90% POLYESTER, 10% PVC, RUBBER

## WADERS NORFIN FLOW

Built from a 4-layer polyester material that offers an optimum balance between durability and breathability. Big external pocket with moisture proof zipper is ideal for bigger tackle box. Inside pocket will keep you most valuable things dry and safe. 4 – Layer, high quality material. Center-leg seam construction. Anatomically sculpted neoprene booties.

- ▶ Outside chest pocket with waterproof zipper
- ▶ Inside, zippered storage pocket
- ▶ Attached, self-fabric gravel guards
- ▶ Integrated belt loops
- ▶ Wading belt included
- ▶ Anatomically sculpted neoprene booties



MATERIAL **70% POLYESTER, 30% PU MEMBRANE, NEOPRENE SOCKS**

WATERPROOFING **20 000 MM**

BREATHABILITY **4000 G/M<sup>2</sup>/24 HOUR**

ITEM NO.	SIZE (**)	MATERIAL
91255-****	S	70% POLYESTER, 30% PU membrane, Neoprene socks
91255-****	M	70% POLYESTER, 30% PU membrane, Neoprene socks
91255-****	L	70% POLYESTER, 30% PU membrane, Neoprene socks
91255-****	XL	70% POLYESTER, 30% PU membrane, Neoprene socks
91255-****	XXL	70% POLYESTER, 30% PU membrane, Neoprene socks
91255-****	XXXL	70% POLYESTER, 30% PU membrane, Neoprene socks

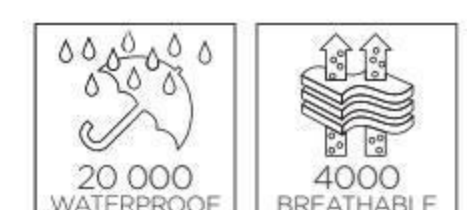



## WADERS WITH BOOTS FREEWATER

Upper part is made from durable 3,5mm neoprene with hi-back upper design for deep wading. Boots are made from light PVC.

Materials: **PVC and NEOPRENE**

- ▶ Neoprene straps
- ▶ Front pocket
- ▶ Reinforced knees



ITEM NO.	SIZE (**)	MATERIAL
81250-****	42	waders
81250-****	43	waders
81250-****	44	waders
81250-****	45	waders
81250-****	46	waders



## NORFIN LIFE VESTS

Motorboat sailing is strictly prohibited without protective equipment such as life jackets. First of all, our safety is our own responsibility, and we have to take care of it first and foremost, before sailing heading out to sail.

### NORFIN LIFE VESTS MODEL SERIES

ITEM NO.	MODEL NO.	DESCRIPTION	COLOUR	WEIGHT KEPT AFLOAT (KG)
50NG-30-50	NORFIN 50NG	with zipper	green	30-50
50NG-50-70	NORFIN 50NG	with zipper	green	50-70
50NG-70-90	NORFIN 50NG	with zipper	green	70-90
50NG-90+	NORFIN 50NG	with zipper	green	> 90
50N-30-50	NORFIN 50N	with zipper	blue	30-50
50N-50-70	NORFIN 50N	with zipper	blue	50-70
50N-70-90	NORFIN 50N	with zipper	blue	70-90
50N-90+	NORFIN 50N	with zipper	blue	> 90
100N-10-20	NORFIN 100N	with zipper and collar	orange	10-20
100N-20-30	NORFIN 100N	with zipper and collar	orange	20-30
100N-30-40	NORFIN 100N	with zipper and collar	orange	30-40
100N-40-60	NORFIN 100N	with zipper and collar	orange	40-60
100N-60-70	NORFIN 100N	with zipper and collar	orange	60-70
100N-70-90	NORFIN 100N	with zipper and collar	orange	70-90
100N-90+	NORFIN 100N	with zipper and collar	orange	> 90
100NK-10-15	NORFIN Kids	with zipper, collar and support	orange	10-20
50NA-40+	NORFIN Automatic	with air chamber	red	> 40
020655	for 50NA-40 Automatic model	reserve CO2 balloon	-	-

### NORFIN 100NK

Intended for keeping children afloat in the water.

- ▶ Large floating collar
- ▶ Front zipper
- ▶ Belt with NEXUS fastener
- ▶ Belt to secure jacket bottom
- ▶ Two drawstring fasteners
- ▶ Whistle
- ▶ Reflective safety stripes



**Colour: orange**

### NORFIN 100N

Intended to keep people afloat in the water.

- ▶ Depending on the model, is able to keep people over 10 kg afloat
- ▶ Large floating collar
- ▶ Front zipper
- ▶ Belt with NEXUS fastener
- ▶ Belt to secure jacket bottom
- ▶ Two drawstring fasteners
- ▶ Whistle
- ▶ Reflective safety stripes



**Colour: orange**

### NORFIN 50NG

Intended to keep people afloat in the water.

- ▶ Depending on the model, is able to keep people over 50 kg afloat
- ▶ Front zipper
- ▶ Belt with NEXUS fastener
- ▶ Two drawstring fasteners
- ▶ For people who can swim and are able to render aid.



**Colour: green**

### NORFIN 50N

Intended to keep people afloat in the water.

- ▶ Depending on the model, is able to keep people over 30 kg afloat
- ▶ Front zipper
- ▶ Belt with NEXUS fastener
- ▶ Two drawstring fasteners
- ▶ For people who can swim and are able to render aid.



**Colour: blue**

### NORFIN 50NA

Intended to keep people afloat in the water. Holding force – air filled in the air chamber by a compressed air balloon

- ▶ Automatic (or manual) operation upon contact with water
- ▶ Compact and does not inhibit movement
- ▶ Waist belt
- ▶ Belt to secure jacket bottom
- ▶ Compressed CO<sub>2</sub> balloon, weight of gas 33 g.



020655

Reserve balloon for automatic life vest inflation with condensed CO<sub>2</sub> gas, weight of gas 33 g.



# NORFIN POLARIZED SUNGLASSES

## LUCKY JOHN



ITEM NO.	BRAND	FRAME	LENSES	CASE
NF-LJ2002	Lucky John	Plastic	Green + Mirror Red	Bag

## LUCKY JOHN



ITEM NO.	BRAND	FRAME	LENSES	CASE
NF-LJ2003	Lucky John	Plastic	Yellow	Bag

## LUCKY JOHN RED



ITEM NO.	BRAND	FRAME	LENSES	CASE
NF-LJ2005	Lucky John	Plastic	Red	Bag

## LUCKY JOHN YELLOW



ITEM NO.	BRAND	FRAME	LENSES	CASE
NF-LJ2006	Lucky John	Plastic	Yellow	Bag

## FLOATING LUCKY JOHN YELLOW



ITEM NO.	BRAND	FRAME	LENSES	CASE
NF-LJ2007	Lucky John	Plastic	Yellow	Bag

## FEEDER CONCEPT



ITEM NO.	BRAND	FRAME	LENSES	CASE
NF-FC2001	Feeder Concept	Plastic	Lenses 1 Green Lenses 2 yellow	Bag

## FEEDER CONCEPT



ITEM NO.	BRAND	FRAME	LENSES	CASE
NF-FC2002	Feeder Concept	Plastic	Brown	Bag

## FEEDER CONCEPT



ITEM NO.	BRAND	FRAME	LENSES	CASE
NF-FC2003	Feeder Concept	Plastic	Grey	Bag

## FEEDER CONCEPT YELLOW



ITEM NO.	BRAND	FRAME	LENSES	CASE
NF-FC2004	Feeder Concept	Plastic	Yellow	Bag

## NORFIN



ITEM NO.	BRAND	FRAME	LENSES	CASE
NF-2001	Norfin	Aluminum	Brown	Hard

## NORFIN



ITEM NO.	BRAND	FRAME	LENSES	CASE
NF-2002	Norfin	Plastic	Gray+Mirror Green	Bag

## NORFIN



ITEM NO.	BRAND	FRAME	LENSES	CASE
NF-2003	Norfin	Plastic	Grey + Mirror Ice Blue	Bag

## NORFIN



ITEM NO.	BRAND	FRAME	LENSES	CASE
NF-2004	Norfin	Plastic	Green	Bag

## NORFIN



ITEM NO.	BRAND	FRAME	LENSES	CASE
NF-2005	Norfin	Plastic	Gray	Bag

## NORFIN



ITEM NO.	BRAND	FRAME	LENSES	CASE
NF-2006	Norfin	Plastic	Green	Bag

### NORFIN



ITEM NO.	BRAND	FRAME	LENSES	CASE
NF-2007	Norfin	Plastic	Yellow	Bag

### NORFIN



ITEM NO.	BRAND	FRAME	LENSES	CASE
NF-2008	Norfin	Plastic	Brown	Bag

### NORFIN



ITEM NO.	BRAND	FRAME	LENSES	CASE
NF-2009	Norfin	Plastic	Gray+Mirror Blue	Bag

### NORFIN CONCEPT



ITEM NO.	BRAND	FRAME	LENSES	CASE
NF-2010	Norfin	Plastic	Yellow	Bag

### NORFIN



ITEM NO.	BRAND	FRAME	LENSES	CASE
NF-2011	Norfin	Plastic	Brow	Bag

### NORFIN GREY



ITEM NO.	BRAND	FRAME	LENSES	CASE
NF-2014	Norfin	Plastic	Grey	Bag

### NORFIN



ITEM NO.	BRAND	MATERIAL
NF-2030	Norfin	Silicone + Steel wire

### NORFIN



ITEM NO.	BRAND
NF-2031	Norfin



**NORFIN**<sup>®</sup>  
ULTIMATE COMFORT

## CARP BED CAMBRIDGE

Fishing  
COLLECTION

**NEW**



ITEM NO.  
NF-20608

TECHNICAL FEATURES:

Size (cm):	210 x 85 x 30
Size when folded (cm):	83 x 75 x 25
Weight (kg):	8,8
Maximum load (kg):	140
Material:	600D polyester
Frame:	aluminium 22 mm, 25 mm

## NORFIN PREMIUM FISHING COLLECTION

Produced by the best manufacturers in the world, Norfin Premium Fishing Line offers comfortable, reliable and ergonomic fishing chairs, carp chairs and bedchairs, which will ensure the highest quality standards for the most professional and demanding fisherman. The chairs and bedchairs are extra – durable to withstand heavy loads and because of the light weight aluminium construction and wide supports, they are easy to set up and will remain stable even on soft and uneven ground near the shore.

### CHAIR CORBY

Fishing  
COLLECTION

NEW



ITEM NO.  
NF-20613

Technical features:

Size (cm):	63 x 55 x 39/102
Size when folded (cm):	76 x 18 x 60
Weight (kg):	5,7
Maximum load (kg):	120
Material:	600D polyester + polar fleece
Frame:	aluminium 22 mm

### CHAIR WINDSOR

Fishing  
COLLECTION

Folding camping chair, features a adjustable back, wide armrests, small side table and a fishing rod holder. Perfectly suitable for fishing.



ITEM NO.  
NF-20601

TECHNICAL FEATURES:

Size (cm):	53 x 60 x 36/90
Size when folded (cm):	60 x 18 x 40
Weight (kg):	7,3
Maximum load (kg):	200
Material:	500D polyester
Frame:	aluminium

### CHAIR HUMBER

Fishing  
COLLECTION

Folding chair, that features separately adjustable front legs with wide supports and U – shaped back legs for additional stability. Cushioned back, soft and comfortable headrest.



ITEM NO.  
NF-20605

TECHNICAL FEATURES:

Size (cm):	70 x 63 x 75/108
Size when folded (cm):	62 x 18 x 97
Weight (kg):	5
Maximum load (kg):	140
Material:	420D polyester with PVC
Frame:	aluminium 19 mm, 25 mm

### CHAIR LINCOLN

Fishing  
COLLECTION

Folding chair, that features a height adjustable comfortable back and separately adjustable legs with wide supports for additional stability. Soft and comfortable headrest. Easy to carry and to fold out. Great choice for fisherman.



ITEM NO.  
NF-20606

TECHNICAL FEATURES:

Size (cm):	52 x 52,5 x 34/103
Size when folded (cm):	77 x 22 x 67
Weight (kg):	6
Maximum load (kg):	140
Material:	600D polyester with Spandex
Frame:	aluminium 22 mm, 25 mm

## TENT NORFIN ZOPE 2

Fishing  
COLLECTION

Double layer pane tent with a semi automatic frame. Both layers – inner and outer – can be assembled at the same time. The tent can be assembled in few seconds by one person.

- one entrance that features a additional mosquito mesh
- pockets for accessories
- all seams are accurately taped

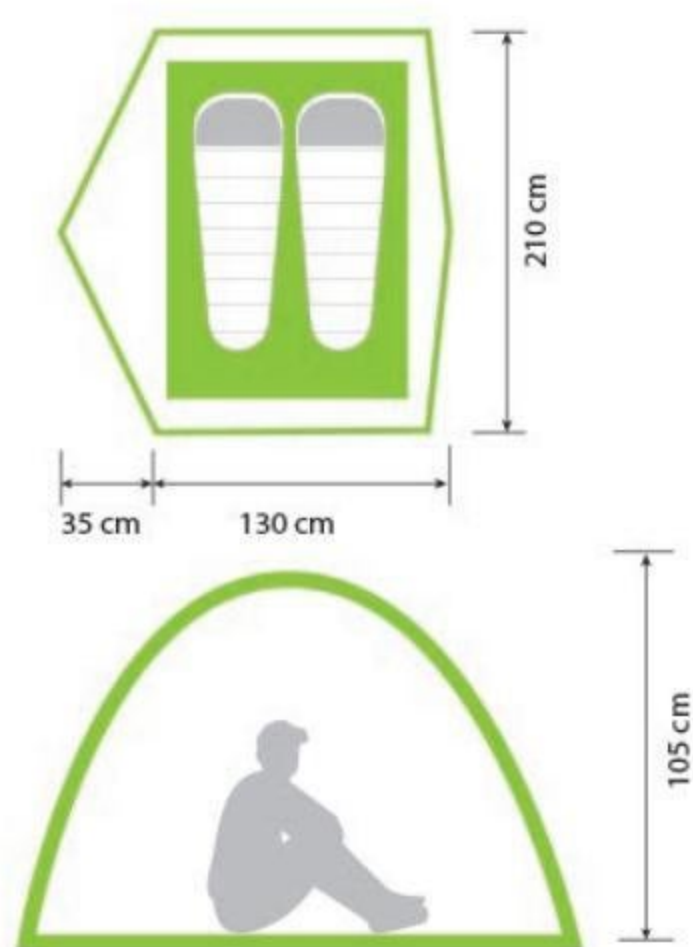

ITEM NO.  
NF-10401

TECHNICAL FEATURES:

Type of tent	Trekking
Capacity (persons)	2
Outer tent size (cm)	(130 + 35) x 210 x 105
Inner tent size (cm)	200 x 120 x 93
Size when packed (cm):	66 x 15 x 15
Weight (kg)	2,9
Outer material/Waterproofing (mm/cm <sup>2</sup> )	190T Polyester PU/ <b>3000</b>
Inner material	190T breathable polyester
Floor material/Waterproofing (mm/cm <sup>2</sup> )	150D Polyester Oxford PU/ <b>6000</b>
Material of poles	FG
Amount of poles/diameter (mm)	-/8,5
Tent pegs material	Steel

## TENT NORFIN TENCH 3

Fishing  
COLLECTION

Spacious double layer pane tent with a semi automatic frame with two entrances and two vestibules. Both layers – inner and outer – can be assembled at the same time. The tent can be assembled in few seconds by one person.

- two entrances and two vestibules
- entrances feature a additional mosquito mesh
- pockets for accessories
- all seams are accurately taped

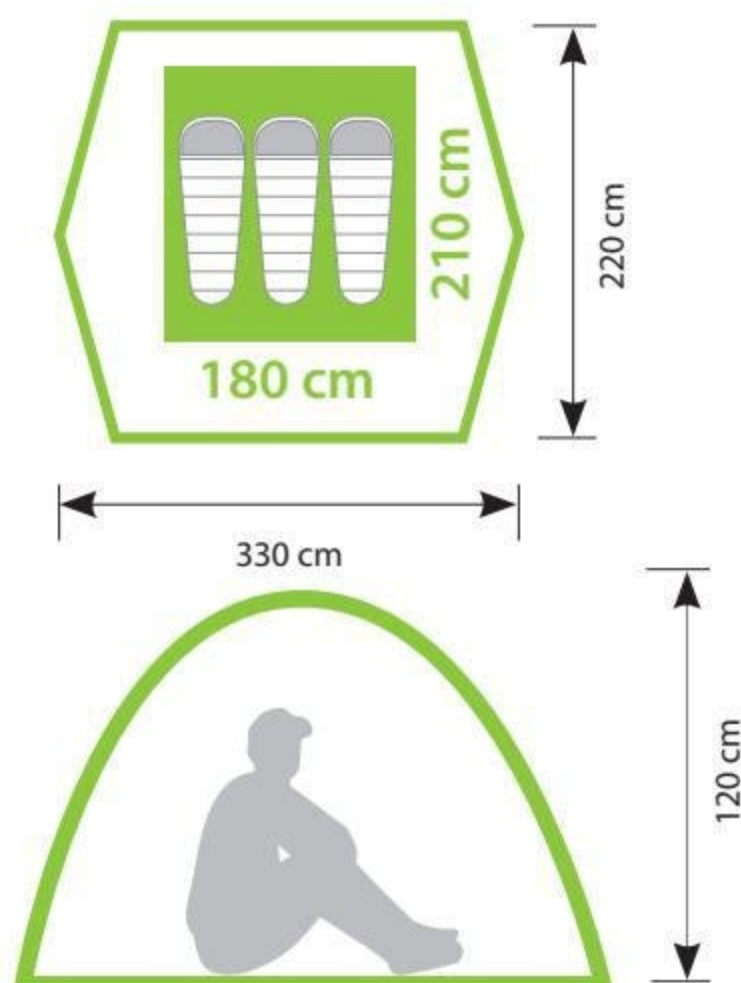
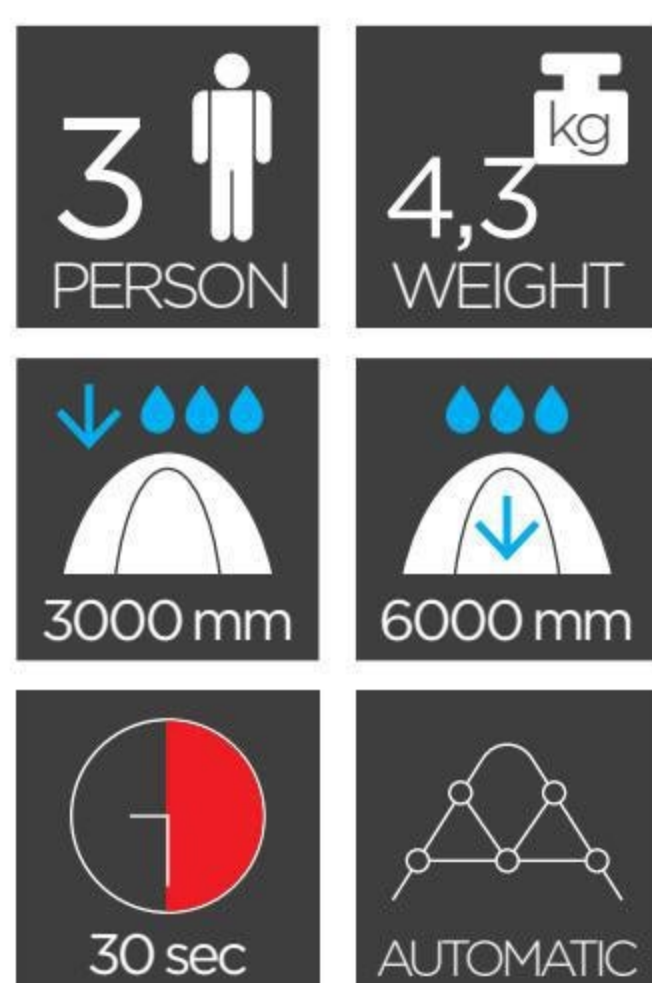

ITEM NO.  
NF-10402

TECHNICAL FEATURES:

Type of tent	Trekking
Capacity (persons)	3
Outer tent size (cm)	(70 + 190 + 70) x 220 x 120
Inner tent size (cm)	210 x 180 x 110
Size when packed (cm):	80 x 16 x 16
Weight (kg)	4,3
Outer material/Waterproofing (mm/cm <sup>2</sup> )	190T Polyester PU/ <b>3000</b>
Inner material	190T breathable polyester
Floor material/Waterproofing (mm/cm <sup>2</sup> )	150D Polyester <b>Oxford</b> PU/ <b>6000</b>
Material of poles	FG
Amount of poles/diameter (mm)	-/8,5
Tent pegs material	Steel



## TENT NORFIN PELED 3

Spacious double layer pane tent with a semi automatic frame for fast and easy assemblment. 3 person capacity. Both layers – inner and outer – can be assembled at the same time. The tent can be assembled in few seconds by one person.

- one entrance
- entrance features a additional mosquito mesh
- pockets for accessories
- all seams are accurately taped
- large vestibule for luggage
- ventilation windows with protecting flaps ensure effective airflow in the tent
- vestibule window features a mosquito mesh
- floor in vestibule corner

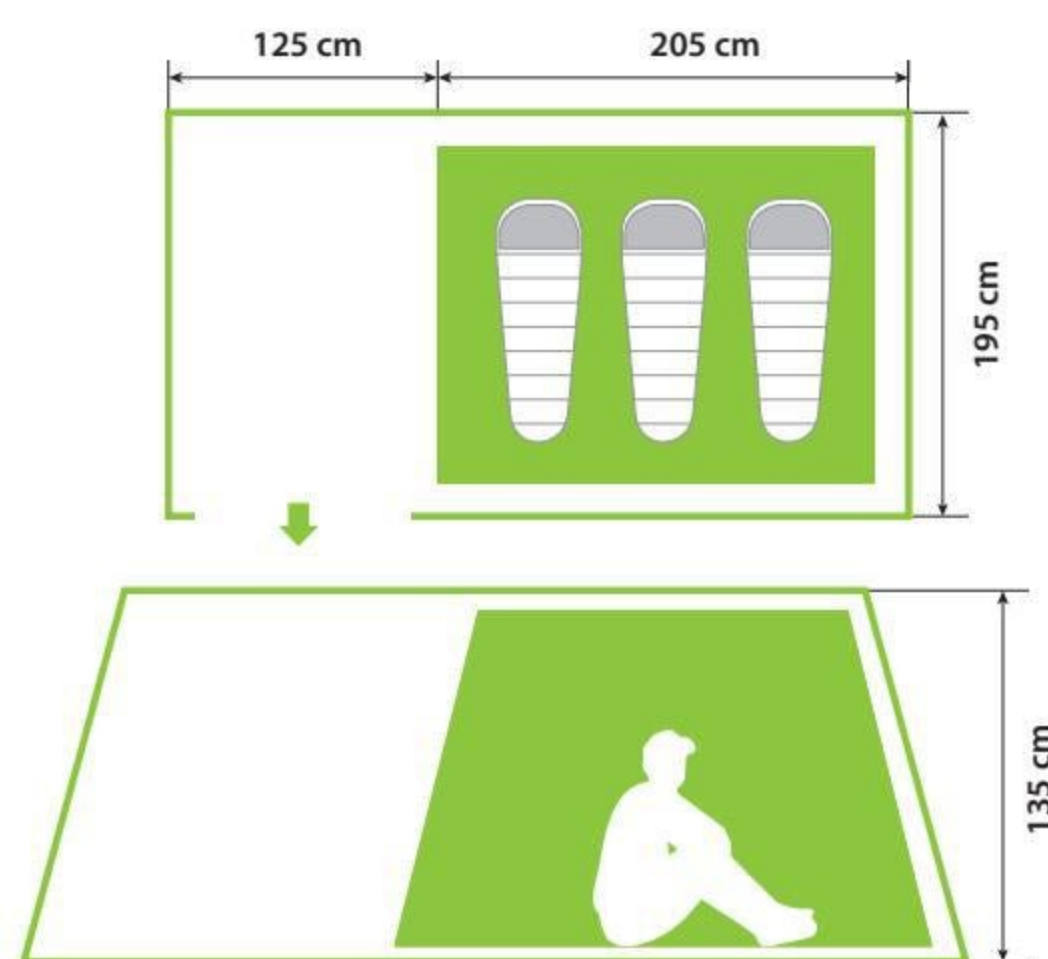

ITEM NO.

NF-10405

TECHNICAL FEATURES:

Type of tent	Trekking
Capacity (persons)	3
Outer tent size (cm)	(125 + 205) x 195 x 135
Inner tent size (cm)	200 x 180 x 120
Size when packed (cm):	96 x 18 x 18
Weight (kg)	6
Outer material/Waterproofing (mm/cm <sup>2</sup> )	190T Polyester PU/ <b>3000</b>
Inner material	190T breathable polyester + B3 mesh
Floor material/Waterproofing (mm/cm <sup>2</sup> )	150D Polyester <b>Oxford</b> PU/ <b>6000</b>
Material of poles	FG
Amount of poles/diameter (mm)	-/8,5 and 9,5
Tent pegs material	Steel

## TENT NORFIN ZANDER 4

4-person camping tent with a semi automatic frame. Equipped with a high and spacious vestibule where you can stand up straight and a large detachable bedroom.

- double layer tent with one entrance
- easy to assemble by one person
- large vestibule for luggage
- removable vestibule floor
- inner entrance features a additional mosquito mesh
- pockets for accessories
- windproof mud flap
- transparent vestibule windows
- all seams are accurately taped

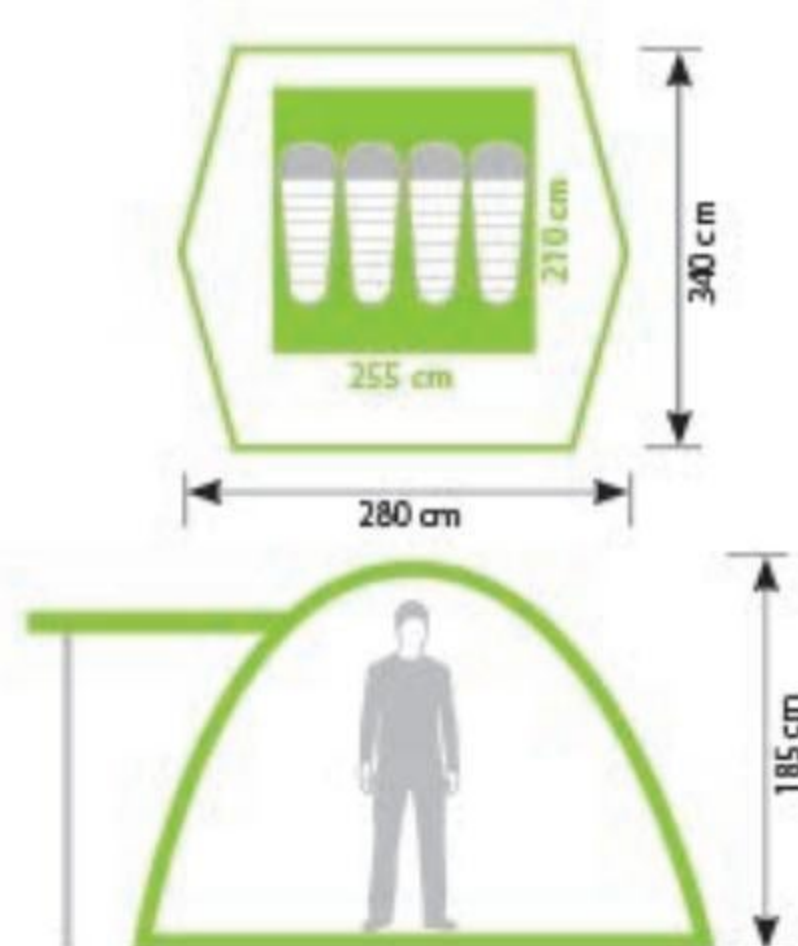

ITEM NO.

NF-10403

TECHNICAL FEATURES:

Type of tent	Camping
Capacity (persons)	4
Outer tent size (cm)	340 x 280 x 185
Inner tent size (cm)	255 x 210 x 170
Size when packed (cm):	105 x 22 x 22
Weight (kg)	8
Outer material/Waterproofing (mm/cm <sup>2</sup> )	190T Polyester PU/ <b>3000</b>
Inner material	190T breathable polyester
Floor material/Waterproofing (mm/cm <sup>2</sup> )	150D Polyester <b>Oxford</b> PU/ <b>6000</b>
Material of poles	FG
Amount of poles/diameter (mm)	-/8,5 and 9,5
Tent pegs material	Steel

## TENT NORFIN SIMO 3

3 person two-layer tent. Very easy to assemble, even on a small site. Minimal weight – maximum comfort.

- one entrance,
- anti-mosquito net on the upper part of the entrance
- pockets for accessories
- ventilation window with protecting flap on the rear wall ensures effective airflow in the tent
- hook for hanging a lantern
- all seams are taped
- loops for fixing the rolled-up entrance

**Family COLLECTION**

3 PERSON

2,8 kg WEIGHT

Fg FIBERGLASS

8000 mm

4000 mm

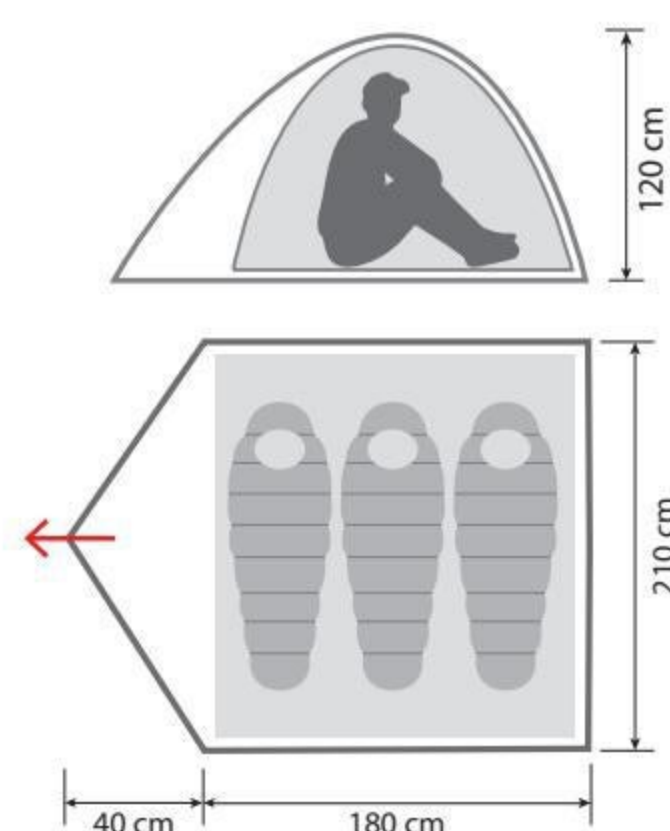

**NEW**

ITEM NO.  
NFL-10101

**TECHNICAL FEATURES:**

Type of tent	Trekking
Capacity (persons)	3
Outer tent size (cm)	(40 + 180) x 210 x 120
Inner tent size (cm)	180 x 210 x 120
Size when packed (cm):	55 x 14 x 14
Weight (kg)	2,8
Outer material/Waterproofing (mm/cm <sup>2</sup> )	<b>190T Polyester PU/4000</b>
Inner material	190T breathable polyester+ B3 mesh
Floor material/Waterproofing (mm/cm <sup>2</sup> )	<b>PE 120 g/m<sup>2</sup>/8000</b>
Material of poles	FG
Amount of poles/diameter (mm)	2/7,9
Tent pegs material	Steel

## TENT NORFIN MAULA 3

Universal 3-person two-layer tent with a spacious vestibule. The third arc above the entrance forms a roof that prevents from getting rain inside even with the vestibule door open.

- one entrance
- anti-mosquito net on the upper part of the entrance
- pockets for accessories
- ventilation window with protecting flap on the rear wall ensures effective airflow in the tent
- hook for hanging a lantern
- all seams taped
- loops for fixing the rolled-up entrance

**Family COLLECTION**

3 PERSON

3,8 kg WEIGHT

Fg FIBERGLASS

8000 mm

4000 mm

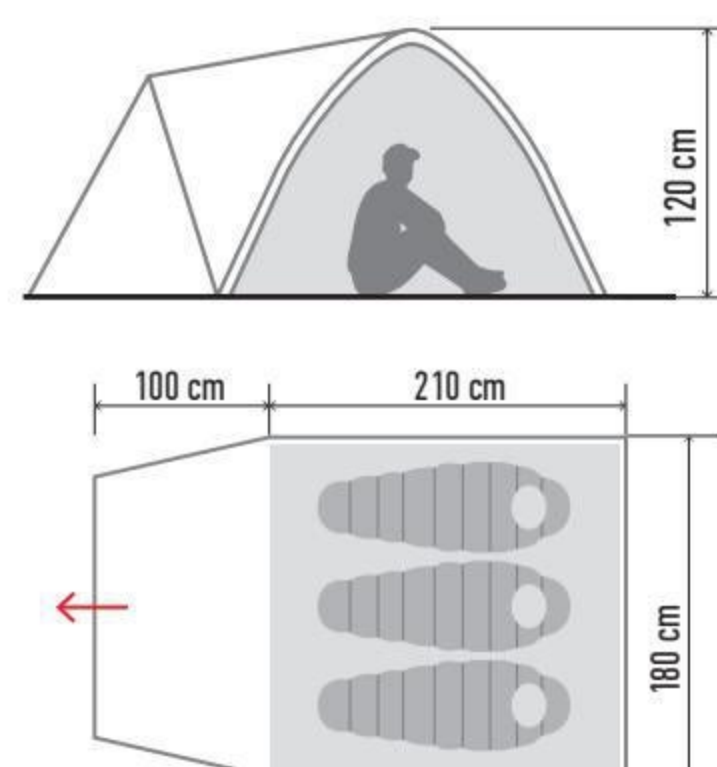

**NEW**

ITEM NO.  
NFL-10102

**TECHNICAL FEATURES:**

Type of tent	Trekking
Capacity (persons)	3
Outer tent size (cm)	(100 + 210) x 180 x 120
Inner tent size (cm)	210 x 180 x 120
Size when packed (cm):	55 x 15 x 14
Weight (kg)	3,8
Outer material/Waterproofing (mm/cm <sup>2</sup> )	<b>190T Polyester PU/4000</b>
Inner material	190T breathable polyester+ B3 mesh
Floor material/Waterproofing (mm/cm <sup>2</sup> )	<b>PE 120g/m<sup>2</sup>/8000</b>
Material of poles	FG
Amount of poles/diameter (mm)	3 7,9/8,5
Tent pegs material	Steel

## TENT NORFIN MARTTI 4

**NEW**

4-person tent for traveling with lot of luggage. One of the most comfortable tents in the trekking group. Two entrances, spacious vestibule

- double layer tent with two entrances
- enlarged vestibule for comfortable placement of luggage
- anti-mosquito net on the upper part of the entrance
- pockets for accessories
- ventilation window with protecting flap on the rear wall ensures effective airflow in the tent
- hook for hanging a lantern
- all seams taped
- loops for fixing the rolled-up entrance



ITEM NO.  
NFL-10103

**TECHNICAL FEATURES:**

Type of tent	Trekking
Capacity (persons)	4
Outer tent size (cm)	(135 + 210) x 240 x 130
Inner tent size (cm)	210 x 240 x 130
Size when packed (cm):	62 x 16 x 17
Weight (kg)	4,6
Outer material/Waterproofing (mm/cm <sup>2</sup> )	<b>190T Polyester PU/4000</b>
Inner material	190T breathable polyester+ B3 mesh
Floor material/Waterproofing (mm/cm <sup>2</sup> )	<b>PE 120g/m<sup>2</sup>/8000</b>
Material of poles	FG
Amount of poles/diameter (mm)	3/7,9/8,5
Tent pegs material	Steel

Family  
COLLECTION

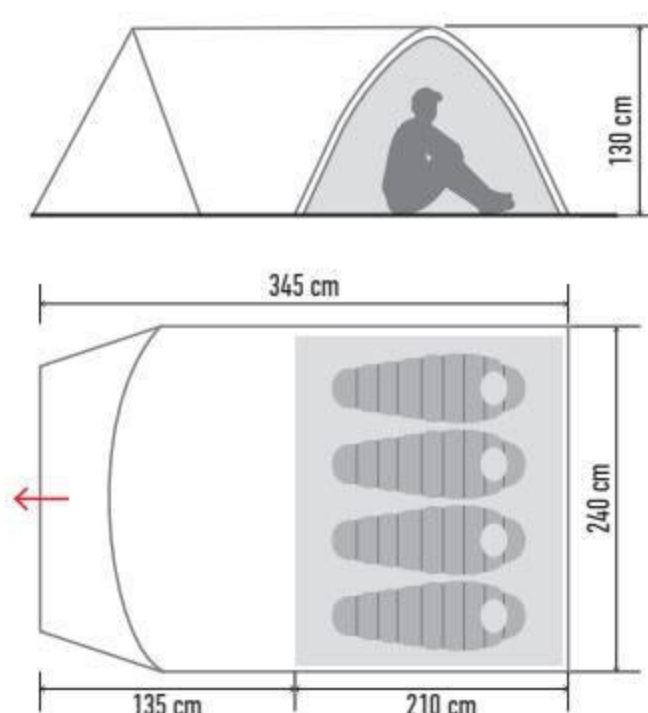

## NORFIN SELF-INFLATING MAT ATLANTIC

**NEW**



ITEM NO.  
NF-30302

Fishing  
COLLECTION

**TECHNICAL FEATURES:**

Size (cm):	190 x 60 x 3,8
Size when packed (cm):	34 x 22 x 22
Weight (kg)	1,6
Material:	External: 150D Oxford Polyester Valve: Bronze with plastic cap

## NORFIN SELF-INFLATING MAT ATLANTIC COMFORT

**NEW**



ITEM NO.  
NF-30303









Fishing  
COLLECTION

**TECHNICAL FEATURES:**

Size (cm):	198 x 63 x 5
Size when packed (cm):	66 x 17 x 17
Weight (kg)	2,2
Material:	External: 150D Oxford Polyester Valve: Bronze with plastic cap

**NEW**

## SLEEPING BAG NORFIN DISCOVERY COMFORT 200

-  Anti - catch webbing along the zipper
-  Combine two sleepingbags
-  Zipper with insulation strap
-  Inner pocket
-  Loops for drying
-  Handy loop on the lock
-  Compression bag
-  RipStop

ITEM NO.	ZIPPER LOCATION
NFL-30228	left side
NFL-30229	right side

**Family**  
COLLECTION



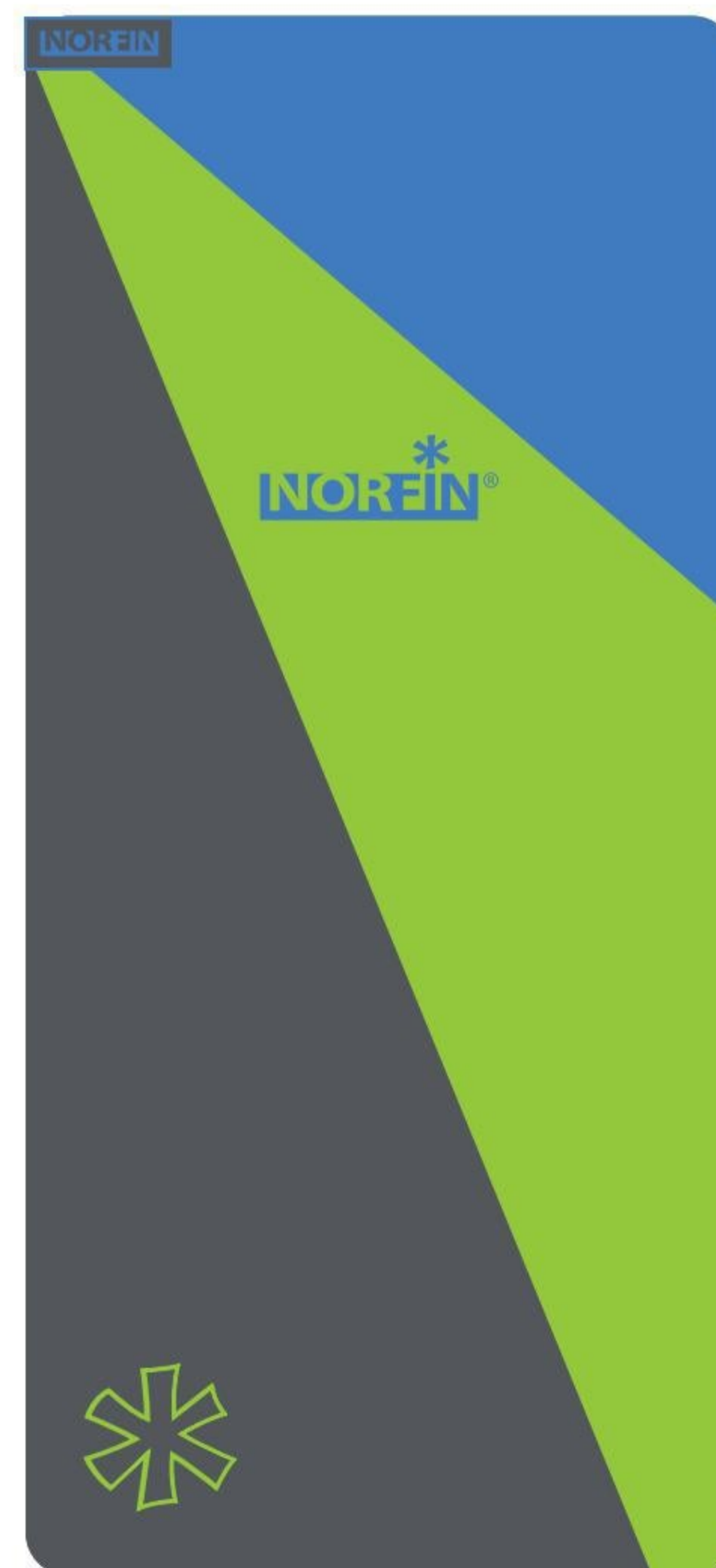







TECHNICAL FEATURES:	
Type:	одеяло
Maximum temperature (°C)	+20
Comfort temperature (°C)	+10
Extreme temperature (°C)	+5
Length (cm)	200
Width (cm)	90
Size when packed (cm):	21 x 29
Weight (kg)	1,9
Outer material	Polyester 210T Diamond RipStop
Inner material	Cotton
Insulation	200 g/m <sup>2</sup> Hollow fiber



**+5** min °C **+10** comfort °C **+20** max °C

## SLEEPING BAG NORFIN ARCTIC 500

**NEW**

-  Anti - catch webbing along the zipper
-  Anatomic hood
-  Warm collar
-  Special pillow space
-  Combine two sleepingbags
-  Zipper with insulation strap
-  Inner pocket
-  Loops for drying
-  Handy loop on the lock
-  Compression bag
-  RipStop

ITEM NO.	ZIPPER LOCATION
NF-30121	left side
NF-30122	right side

**Fishing**  
COLLECTION











TECHNICAL FEATURES:	
Type:	Cocoon
Maximum temperature (°C)	0
Comfort temperature (°C)	-10
Extreme temperature (°C)	-20
Length (cm)	230
Width (cm)	85-55
Size when packed (cm):	26 x 46
Weight (kg)	2,5
Outer material	Polyester 210T Diamond RipStop
Inner material	Polyester 190T
Insulation	500 g/m <sup>2</sup> Hollow fiber



**-20** min °C **-10** comfort °C **0** max °C

## SLEEPING BAG NORFIN ATLANTIS COMFORT PLUS 350

**NEW**

-  Zipper with insulation strap
-  Inner pocket
-  Anti-catch webbing along the zipper
-  Loops for drying
-  Warm collar
-  Handy loop on the lock
-  Special pillow space
-  Compression bag
-  Combine two sleepingbags
-  RipStop

ITEM NO.	ZIPPER LOCATION
NFL-30232	left side
NFL-30233	right side

Family  
COLLECTION













**TECHNICAL FEATURES:**

Type:	blanket
Maximum temperature (°C)	+10
Comfort temperature (°C)	0
Extreme temperature (°C)	-10
Length (cm)	230
Width (cm)	100
when packed (cm):	27 x 44
Weight (kg)	2.9
Outer material	Polyester 210T Diamond RipStop
Inner material	Cotton
Insulation	350 g/m <sup>2</sup> Hollow fiber



## SLEEPING BAG NORFIN DISCOVERY 200

**NEW**

-  Light and compact
-  Zipper with insulation strap
-  Anti-catch webbing along the zipper
-  Inner pocket
-  Anatomic hood
-  Loops for drying
-  Warm collar
-  Handy loop on the lock
-  Special pillow space
-  Compression bag
-  Combine two sleepingbags
-  RipStop

ITEM NO.	ZIPPER LOCATION
NF-30115	left side
NF-30116	right side

Fishing  
COLLECTION

**TECHNICAL FEATURES:**

Type:	Cocoon
Maximum temperature (°C)	+15
Comfort temperature (°C)	+10
Extreme temperature (°C)	0
Length (cm)	220
Width (cm)	80-55
Size when packed (cm):	22 x 37
Weight (kg)	1.4
Outer material	Polyester 210T Diamond RipStop
Inner material	Polyester 190T
Insulation	200 g/m <sup>2</sup> Hollow fiber



## BACKPACK NORFIN ADVENTURE 65

**NEW**

-  The main compartment is divided in two parts by a membrane, allowing a convenient distribution of loaded items
-  Hipbelt
-  Anatomic shoulder straps, equipped with a layer of foam and Air Mesh
-  Chest strap
-  Easy access to the main compartment from top and bottom entrances
-  «Hose portals» for sip tube.
-  Ddjustable top lid
-  Front zip pocket
-  Raincover
-  Aluminum plate
-  Possibility of fastening trekking poles
-  Possibility of fastening mountain equipment
-  Two mesh side pockets
-  V-1 carrying system for comfortable adjustment to any back length
-  Large front pocket with fastex fasteners with the ability to adjust the volume



 75 x 37 x 27 SIZE CM	 65 CAPACITY	 2 WEIGHT
-------------------------------------------------------------------------------------------------------------	----------------------------------------------------------------------------------------------------	-------------------------------------------------------------------------------------------------

ITEM NO.  
NFL-40221

Family  
COLLECTION

**TECHNICAL FEATURES:**

Size (cm):	75 x 37 x 27
Volume (l):	65
Weight (kg):	2,0
Material:	polyester 420D ripstop, 600D Oxford, coating PU

## BACKPACK NORFIN ADVENTURE 55

**NEW**

-  The main compartment is divided in two parts by a membrane, allowing a convenient distribution of loaded items
-  Hipbelt
-  Anatomic shoulder straps, equipped with a layer of foam and Air Mesh
-  Chest strap
-  Easy access to the main compartment from top and bottom entrances
-  «Hose portals» for sip tube.
-  Ddjustable top lid
-  Front zip pocket
-  Raincover
-  Aluminum plate
-  Possibility of fastening trekking poles
-  Possibility of fastening mountain equipment
-  Two mesh side pockets
-  V-1 carrying system for comfortable adjustment to any back length
-  Large front pocket with fastex fasteners with the ability to adjust the volume



 72 x 35 x 26 SIZE CM	 55 CAPACITY	 1,8 WEIGHT
-------------------------------------------------------------------------------------------------------------	----------------------------------------------------------------------------------------------------	---------------------------------------------------------------------------------------------------

ITEM NO.  
NFL-40220













Family  
COLLECTION

**TECHNICAL FEATURES:**

Size (cm):	72 x 35 x 26
Volume (l):	55
Weight (kg):	1,8
Material:	polyester 420D ripstop, 600D Oxford, coating PU

## BACKPACK NORFIN ADVENTURE 45

**NEW**

-  The carrying system is divided in three zones and the durable Air Mesh lining wicks away warmth and moisture
-  Hipbelt
-  Anatomic shoulder straps, equipped with a layer of foam and Air Mesh
-  Chest strap
-  Easy access to the main compartment from top and bottom entrances
-  «Hose portals» for sip tube.
-  Ddjustable top lid
-  Front zip pocket
-  Raincover
-  Aluminum plate
-  Possibility of fastening trekking poles
-  Possibility of fastening mountain equipment
-  Two mesh side pockets



ITEM NO.  
NFL-40219

Family  
COLLECTION









**TECHNICAL FEATURES:**

Size (cm):	61 x 32 x 20
Volume (l):	45
Weight (kg):	1,2
Material:	polyester 420D ripstop, 600D Oxford, coating PU

 61 x 32 x 20 SIZE CM	 45 CAPACITY	 1,2 WEIGHT
-------------------------------------------------------------------------------------------------------------	----------------------------------------------------------------------------------------------------	---------------------------------------------------------------------------------------------------

## HERMETIC BACKPACK NORFIN DRY BAG 35

**NEW**

-  Anatomic shoulder straps, equipped with a layer of foam and Air Mesh
-  Chest strap
-  Front pocket with waterproof zip, two inside pockets with zip
-  One interior compartment, two interior zip pockets
-  Easy access to the main compartment from top and bottom entrances
-  Waterproof zippers
-  The seams are taped
-  Two side combined pockets that change volume
-  Front straps for a rug or other cargo



ITEM NO.  
NF-40303

Fishing  
COLLECTION











**TECHNICAL FEATURES:**



Size (cm):	35 x 21 x 53
Volume (l):	35
Weight (kg):	0,8
Material:	420 Nylon TPU

 35 x 21 x 53 SIZE CM	 35 CAPACITY	 0,8 WEIGHT
-------------------------------------------------------------------------------------------------------------	----------------------------------------------------------------------------------------------------	---------------------------------------------------------------------------------------------------

**NEW**

## BACKPACK NORFIN LAGOON 25

-  Padded back with ventilation channel
-  Anatomic shoulder straps, equipped with a layer of foam and Air Mesh
-  Chest strap
-  Easy access to the main compartment from top and bottom entrances
-  Front zip pocket with two small inside pockets
-  Large internal pocket in main compartment
-  Top zip pocket
-  Two side pockets  
Lateral fastami fixation
-  Possibility of fastening mountain equipment
-  Possibility of fastening trekking poles
-  «Hose portals» for sip tube.

 50x19x32 SIZE CM	 25 CAPACITY	 0,55 WEIGHT
---------------------------------------------------------------------------------------------------------	----------------------------------------------------------------------------------------------------	----------------------------------------------------------------------------------------------------



ITEM NO.  
NF-40232





Fishing  
COLLECTION

**TECHNICAL FEATURES:**

Size (cm):	50 x 19 x 32
Volume (l):	25
Weight (kg):	0,55
Material:	polyester 450D Honeycomb RipStop, coating PU

## BACKPACK NORFIN CASCADE 25

**NEW**

-  Two mesh side pockets
-  Anatomic shoulder straps, equipped with a layer of foam and Air Mesh
-  Easy access to the main compartment from top and bottom entrances
-  Front pocket with simple internal zip organization

 48x13x30 SIZE CM	 25 CAPACITY	 0,4 WEIGHT
---------------------------------------------------------------------------------------------------------	----------------------------------------------------------------------------------------------------	---------------------------------------------------------------------------------------------------



ITEM NO.  
NF-40231

Fishing  
COLLECTION





**TECHNICAL FEATURES:**

Size (cm):	48 x 13 x 30
Volume (l):	25
Weight (kg):	0,4
Material:	polyester 600D



## BACKPACK NORFIN ENERGY

**NEW**

-  Padded reinforced back with inner zip pocket
-  Easy access to the main compartment from top and bottom entrances
-  Front zip pocket
-  Interior compartment with additional pocket



 37x20x7 SIZE CM	 5 CAPACITY	 0,2 WEIGHT
--------------------------------------------------------------------------------------------------------	---------------------------------------------------------------------------------------------------	---------------------------------------------------------------------------------------------------

ITEM NO.  
NF-40234

Fishing  
COLLECTION

**TECHNICAL FEATURES:**

Size (cm):	37 x 20 x 7
Volume (l):	5
Weight (kg):	0,2
Material:	nylon 420D

## BACKPACK NORFIN HARBOUR 22

**NEW**

-  Two mesh side pockets
-  Anatomic shoulder straps, equipped with a layer of foam and Air Mesh
-  Internal pocket for laptop
-  Easy access to the main compartment from top and bottom entrances
-  Front zip pocket
-  Large internal pocket with organizer, key clip in the front compartment
-  Padded reinforced back



ITEM NO.  
NF-40230

Fishing  
COLLECTION

**TECHNICAL FEATURES:**

Size (cm):	47 x 14 x 34
Volume (l):	22
Weight (kg):	0,35
Material:	polyester 420D ripstop, 600D Oxford, coating PU

 47x14x34 SIZE CM	 22 CAPACITY	 0,35 WEIGHT
---------------------------------------------------------------------------------------------------------	----------------------------------------------------------------------------------------------------	----------------------------------------------------------------------------------------------------

## BACKPACK NORFIN TACTIC 35

Multifunctional city backpack.



Large front pockets



Front pocket with organizer



Internal pocket for laptop



The carrying system is divided in three zones and the durable Air Mesh lining wicks away warmth and moisture



Hip belt



Anatomic shoulder straps, equipped with a layer of foam and Air Mesh



Two side pockets



Internal mesh pocket



«Hose portals» for sip tube



Fishing  
COLLECTION



40x17x48  
SIZE CM



35  
CAPACITY



1,4  
WEIGHT

ITEM NO.  
NF-40221

TECHNICAL FEATURES:

Size (cm):	40 x 17 x 48
Volume (l):	35
Weight (kg):	1,4
Material:	polyester 600D waterproof

## BACKPACK NORFIN TACTIC 45

Military style city backpack.



Chest strap



«Hose portals» for sip tube.



Front pocket with organizer



Internal pocket for laptop



V-1 carrying system for comfortable adjustment to any back length



Anatomic shoulder straps, equipped with a layer of foam and Air Mesh



Large front pocket and lined front pocket for glasses



Two side pockets



The main compartment is divided in two parts by a membrane, allowing a convenient distribution of loaded items



Fishing  
COLLECTION



43x20x51  
SIZE CM



45  
CAPACITY



1,6  
WEIGHT











ITEM NO.  
NF-40222

TECHNICAL FEATURES:

Size (cm):	43 x 20 x 51
Volume (l):	45
Weight (kg):	1,6
Material:	polyester 600D waterproof

## BACKPACK NORFIN TACTIC 65

Military style backpack for distant hikes.

-  Hipbelt
-  Anatomic shoulder straps, equipped with a layer of foam and Air Mesh
-  Chest strap
-  Internal, aluminium frame
-  Easy access to the main compartment from top and bottom entrances
-  Large front pockets
-  Adjustable top lid
-  Two side pockets
-  The main compartment is divided in two parts by a membrane, allowing a convenient distribution of loaded items
-  Raincover
-  V-1 carrying system for comfortable adjustment to any back length

40x18x65  
SIZE CM

65  
CAPACITY

2.0  
WEIGHT



ITEM NO.  
NF-40223

TECHNICAL FEATURES:

Size (cm):	65 x 18 x 40
Volume (l):	65
Weight (kg):	2
Material:	polyester 600D waterproof

## THERMAL BAG NORFIN LUIRO-L

This thermal bag features a insulated easy – care food storage, comfortable webbing handles and adjustable shoulder strap. Very compact when folded.

35  
CAPACITY

ITEM NO.  
NFL-40104



TECHNICAL FEATURES:

Size (cm):	44 x 32 x 32
Weight (kg):	1,6
Material:	600D polyester, PEVA lining

## WATERPROOF POUCH NORFIN DRY CASE 01/CASE 02/CASE 03

Waterproof pouch, manufactured to ensure protection to your cell phone, documents and accessories.

- ▶ Perfectly suitable for protection of medium and large size cell phones, with a diagonal measurement of up to 6 inches.
- ▶ The plastic material is touch sensitive, allowing you to use your cell phone without removing it from the pouch.

NF-40306



0,03  
WEIGHT

14 x 25  
SIZE CM

ITEM NO.  
NF-40306  
NF-40307  
NF-40308

NF-40307



10 x 22  
SIZE CM

0,03  
WEIGHT

NF-40306 TECHNICAL FEATURES:  
Size (cm): 14 x 25  
Weight (kg): 0,03  
Material: 180T Polyester TPU

NF-40308



17 x 27  
SIZE CM

0,05  
WEIGHT

NF-40307 TECHNICAL FEATURES:

Size (cm):	10 x 22/10 x 16
Weight (kg):	0,035
Material:	210T Polyester TPU
Features:	DuraFle x

## NORFIN CAMPING FURNITURE

Take the comfort outdoors with Norfin camping furniture collection. It includes comfortable and practical chairs, tables, cupboards, kitchens and folding beds, which benefit of a modern design, light and durable constructions, and high quality materials. The foldable furniture is very easy to set up and to fold away in a carry bag or a self contained suitcase.

### CHAIR RAISIO



Folding chair with a durable mesh back will ensure comfort in a hot summer day. Equipped with arm rest cup holder for your drink.



ITEM NO.  
NF-20106

**TECHNICAL FEATURES:**

Size (cm):	54 x 42 x 43/95
Size when packed (cm):	23 x 22 x 93
Weight (kg):	2,6
Ma x imum load (kg):	100
Material:	600D polyester
Frame:	Steel 16 mm

### CHAIR VANTAA



Folding chair with a especially durable, reinforced aluminium frame. The construction of the frame ensures more stability. Features a side table and a side pocket for accessories.



ITEM NO.  
NF-20205

**TECHNICAL FEATURES:**

Size (cm):	48 x 35 x 47/82
Size when packed (cm):	82 x 47 x 12
Weight (kg):	2,9
Ma x imum load (kg):	100
Material:	600D polyester
Frame:	aluminium 25 mm

### CHAIR RISOR



Folding chair with special, heavy duty aluminium frame construction, that ensures more stability on sand or crumbly earth . Features a side table, side pockets for accessories and cushioned back and seat.



ITEM NO.  
NF-20203

**TECHNICAL FEATURES:**

Size (cm):	47 x 42 x 43/80
Size when packed (cm):	82 x 54 x 18
Weight (kg):	3,5
Ma x imum load (kg):	100
Material:	600D polyester, 420DRipStop Nylon
Frame:	aluminium 30 x 16 mm

### CHAIR ODDA



Light and comfortable, classic stool of a tripod design.



ITEM NO.  
NF-20208

**TECHNICAL FEATURES:**

Size (cm):	31 x 31 x 43
Size when packed (cm):	55 x 8 x 6
Weight (kg):	0,6
Ma x imum load (kg):	100
Material:	600D polyester
Frame:	aluminium 19 mm

## CHAIR NORFIN VIHTI

**NEW**

Round folding chair. Soft, padded seat and back, durable construction. Plastic corner clips on the legs make this chair especially stable.



ITEM NO.  
NF-20224

Fishing  
COLLECTION

**TECHNICAL FEATURES:**

Size (cm):	85 x 69 x 38/78
Size when folded (cm):	89 x 20 x 27
Weight (kg):	4,7
Maximum load (kg):	100
Material:	600D polyester
Frame:	steel 16 mm

## STOOL-BACKPACK NORFIN DUDLEY

Fishing  
COLLECTION

Lightweight backpack folding chair. The bag features 4 external pockets. Soft seat area.



ITEM NO.  
NF-20702

**TECHNICAL FEATURES:**

Size (cm):	34 x 39 x 42
Size when folded (cm):	55 x 32 x 10
Weight (kg):	1,8
Maximum load (kg):	120
Material:	600D polyester
Frame:	steel 16 mm

## CHAIR TAMPERE

Fishing  
COLLECTION

Folding chair with aluminium frame. Light and compact.



ITEM NO.  
NF-20208

**TECHNICAL FEATURES:**

Size (cm):	34 x 33 x 46
Size when packed (cm):	55 x 33 x 3
Weight (kg):	0,6
Maximum load (kg):	100
Material:	600D polyester
Frame:	aluminium 22 mm

## CHAIR LUDVIKA

Fishing  
COLLECTION

Folding chair with aluminium frame. Light and compact, features a back.



ITEM NO.  
NF-20209

**TECHNICAL FEATURES:**

Size (cm):	45,5 x 37 x 75
Size when packed (cm):	63 x 37 x 5
Weight (kg):	0,6
Maximum load (kg):	100
Material:	600D polyester
Frame:	aluminium 22 mm

## TABLE GAULA-L

Fishing  
COLLECTION

Compact folding table equipped with a aluminium frame and MDF top. Easy to set up and fold away.



Item No.  
NF-20307

**TECHNICAL FEATURES:**

Size (cm):	120 x 60 x 30/71
Size when packed (cm):	56 x 56 x 6,5
Weight (kg):	4,5
Maximum load (kg):	30
Frame:	aluminium 25 mm, MDF

## TABLE GAULA-M

Fishing  
COLLECTION

Compact folding table equipped with a aluminium frame and MDF top. Easy to set up and fold away.



Item No.  
NF-20306

**TECHNICAL FEATURES:**

Size (cm):	90 x 60 x 30/70
Size when packed (cm):	60 x 6 x 45
Weight (kg):	4
Maximum load (kg):	30
Frame:	aluminium 25 mm, MDF

## TABLE RUNN

Fishing  
COLLECTION

The perfect picnic set to take the meal outdoors. It features a folding table and four chairs. The table and chairs lock together for self contained storage, forming a compact suitcase. Easy to set up and to fold away.



ITEM NO.  
NF-20310

**TECHNICAL FEATURES:**

Size (cm):	120 x 60 x 70
Size when packed (cm):	60 x 60 x 8
Weight (kg):	7,6
Maximum load (kg):	Table – 30, chairs – 90
Frame:	aluminium 25 x 22 mm, MDF, 600D polyester



A man in winter fishing gear, including a dark jacket, a patterned vest, a cap, and sunglasses, is shown from the chest up. He is holding a fishing rod with both hands, and a fish is visible in his left hand. The background is a bright, cloudy sky. The text 'Lucky John' is written in a large, red, cursive font, and 'WINTER PRODUCTS' is written in a smaller, red, sans-serif font below it.

# Lucky John®

WINTER  
PRODUCTS

## LUCKY JOHN ICE FISHING RODS **F-TECH JIGGING**

### BLANK

- ▶ Material reinforced fiberglass
- ▶ Flat Tip two section rod
- ▶ Medium soft
- ▶ Loop shape hook keeper

### HANDLE

- ▶ Material AAA grade cork
- ▶ Screw type reel seat

### GUIDES

- ▶ LTS inserts

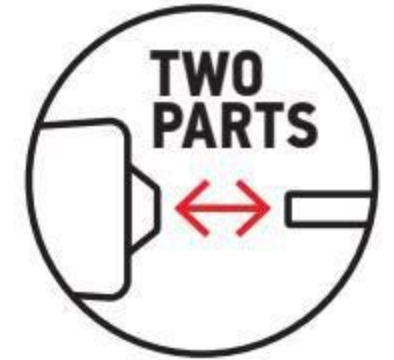

ITEM NO.	LENGTH (CM)	CLOSE LENGTH (CM)	WEIGHT (G)
LJ110-01	40	28	52
LJ110-02	50	38	56



## LUCKY JOHN ICE FISHING RODS **X-TECH ZANDERX**

### BLANK

- ▶ Material carbon fiber (30T)
- ▶ One section rod
- ▶ Hard

### HANDLE

- ▶ Material Hard EVA
- ▶ Screw type reel seat
- ▶ Ergonomic, gun shape

### GUIDES

- ▶ Dynaflo inserts

The rod comes with plastic tube.



ITEM NO.	LENGTH (CM)	CLOSE LENGTH (CM)	WEIGHT (G)
LJ140-01	73	74,5	82
LJ140-02	93	97,5	95

## LUCKY JOHN ICE FISHING RODS **ZANDER HT**

### BLANK

- ▶ Material carbon fiber (30T)
- ▶ Solid Tip two section rod
- ▶ Hard
- ▶ Loop shape hook keeper

### HANDLE

- ▶ Material AAA grade cork and EVA
- ▶ Screw type reel seat

### GUIDES

- ▶ LTS inserts



ITEM NO.	LENGTH (CM)	CLOSE LENGTH (CM)	WEIGHT (G)
LJ109-01	52	36,5	65





## LUCKY JOHN ICE FISHING RODS **C-TECH ALL-IN-1 PERCH/PEARCH S**

### BLANK:

- ▶ Material carbon fibre (30T)
- ▶ Solid Tip one section rod
- ▶ Medium hard – PEARCH
- ▶ Medium soft – PEARCH S
- ▶ Loop shape hook keeper

### HANDLE:

- ▶ Material AAA grade cork
- ▶ Adjustable reel seat

### GUIDES:

- ▶ Stainless steel lightweight
- ▶ SIC top guide



LJ116-01



LJ117-01

ITEM NO.	LENGTH (CM)	WEIGHT (G)
LJ116-01	44	34
LJ117-01	51	35

**ALL IN ONE**

**LJ C-TECH PERCH 45 ALL IN ONE**

**LJ C-TECH PERCH S 51 ALL IN ONE**

## LUCKY JOHN ICE FISHING RODS **C-TECH PIKE**

### BLANK:

- ▶ Material carbon fiber (30T)
- ▶ Solid Tip two section rod
- ▶ Medium hard
- ▶ Loop shape hook keeper

### HANDLE:

- ▶ Material AAA grade cork and EVA
- ▶ Screw type reel seat

### GUIDES:

- ▶ Stainless steel lightweight
- ▶ SIC inserts



ITEM NO.	LENGTH (CM)	CLOSE LENGTH (CM)	WEIGHT (G)
LJ115-01	60	44	64

**LJ C-TECH PIKE 60**

## LUCKY JOHN TELESCOPIC ICE FISHING RODS **C-TECH VIKING**

### BLANK:

- ▶ Material carbon fiber (30T)
- ▶ Telescopic
- ▶ Hard

### HANDLE:

- ▶ Material AAA grade cork and EVA
- ▶ Screw type reel seat

### GUIDES:

- ▶ SIC inserts



ITEM NO.	LENGTH (CM)	CLOSE LENGTH (CM)	WEIGHT (G)
LJ112-01	55	30	58

**LJ C-TECH VIKING 55**

## LUCKY JOHN TELESCOPIC ICE-FISHING RODS **TRAVEL HARD**

### BLANK:

- ▶ Telescopic
- ▶ Soft, Medium hard

### HANDLE:

- ▶ Material (hard) EVA
- ▶ Adjustable reel seat

### GUIDES:

- ▶ Dynaflo



ITEM NO	LENGTH (CM)	CLOSE LENGTH (CM)
LJ101-02	50	37



## LUCKY JOHN TELESCOPIC ICE FISHING RODS **C-TECH JIG LIGHT**

### BLANK:

- ▶ Material carbon fibre (30T)
- ▶ Telescopic
- ▶ Medium hard

### HANDLE:

- ▶ Material AAA grade cork
- ▶ Frost-resistant plastic reel

### GUIDES:

- ▶ Stainless steel



ITEM NO.	LENGTH (CM)	CLOSE LENGTH (CM)	WEIGHT (G)	BEC (Γ)
LJ114-01	55	3	30	



## LUCKY JOHN ICE FISHING RODS **LDR**

LDR – light and reliable multifunctional rods designed, first and foremost, for balanced and vertical lure fishing. An open spool allows controlling the quality of reeling of the fishing line, necessary for this type of fishing rods in winter time.

### BLANK:

- ▶ Two section rod
- ▶ medium-hard fiberglass tip
- ▶ LJ100-05 equipped with soft feeder tip

### GUIDES:

- ▶ Stainless steel guide on the handle
- ▶ Ceramic top guide insert

### HANDLE:

- ▶ Material Neoprene
- ▶ Spool stop/release button
- ▶ LJ100-01 short handle



ITEM NO.	LENGTH (CM)	∅ REEL (MM)	WEIGHT (G)
LJ100-02	36	50	43
LJ100-03	40	75	73
LJ100-06	45	50	29

## LUCKY JOHN ICE FISHING RODS **PILKKI**



LJ160-01  
LJ161-01  
LJ162-01



LJ162-02

ITEM NO.	LENGTH (CM)	CLOSE LENGTH (CM)	Ø REEL (MM)	WEIGHT (G)	DESCRIPTION
LJ160-01	28	28	55	23	handle EVA
LJ161-01	32	32	55	23,5	handle EVA
LJ162-01	40	40	57	41	handle EVA
LJ162-02	40	40	57	42	handle cork

## LUCKY JOHN **ICE ECOROD**



ITEM NO.	LENGTH (CM)	Ø REEL (MM)	WEIGHT (G)	COLOR
450-01	25	50	28	yellow

## LUCKY JOHN BALALAIKA ICE-FISHING RODS **MORMAX**

A lightweight and convenient fishing rod for winter mormyshka angling.

- ▶ High quality polystyrene body
- ▶ Special plastic washers for smooth spooling
- ▶ Line hole protected with plastic tube

Special plastic washers for smooth spooling

Line hole protected with plastic tube

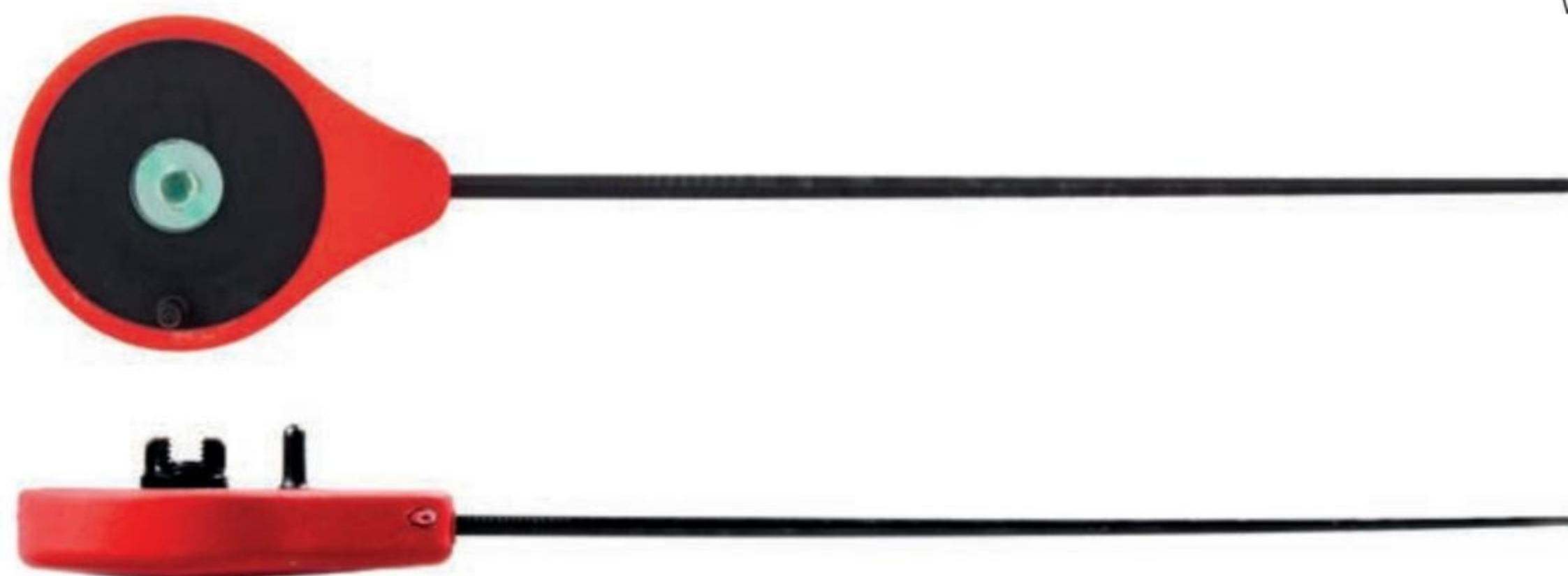

ITEM NO.	LENGTH (CM)	Ø REEL (MM)	WEIGHT (G)	COLOR
LJ103-01	24,6	45	17	yellow
LJ103-02	24,6	45	17	red
LJ103-03	24,6	45	17	green



**NEW**

## ICE FISHING ROD SET **LUCKY JOHN MORMYSHKA SET**

Set for fishing with a *mormyshka*. Consists of a «balalaika» type ice fishing rod, fishing line, strike indicator and two tungsten *mormyshkas*. The ergonomic rod perfectly fits in the hand. Thin, but at the same time strong line, combined with a specially selected strike indicator, will ensure the correct play of the *mormyshkas*. *Mormyshkas* made in the popular «ball» and «drop» shapes, will allow you to fish successfully in a variety of conditions. An excellent choice for both beginners and experienced anglers.



ITEM NO.	ROD		STRIKE INDICATOR LENGTH (MM), TEST (G)	LINE			MORMYSHKA			
	LENGTH (CM)	WEIGHT (G)		DIAM. (MM)	LENGTH (M)	TEST (KG)	TYPE, COLOR	SIZE	TYPE, COLOR	SIZE
LJ122SET	23	24	100, 0,4-0,8	0,12	30	1,18	ball, gold	040	Drop, black nickel	030

**NEW**

## ICE FISHING ROD SET **LUCKY JOHN PERCH SET**

A set designed primarily for perch fishing. Consists of a rod, reel, line and vertical lure. A sensitive yet durable rod made of quality graphite, it comes with a comfortable winter fishing reel that has extended leg for fishing with warm winter gloves. A strong 0.2 mm; 50 m line will allow you to get a weighty trophy. A catchy lure of a classic shape does not require specific fishing skills. An excellent choice for both beginners and experienced anglers.

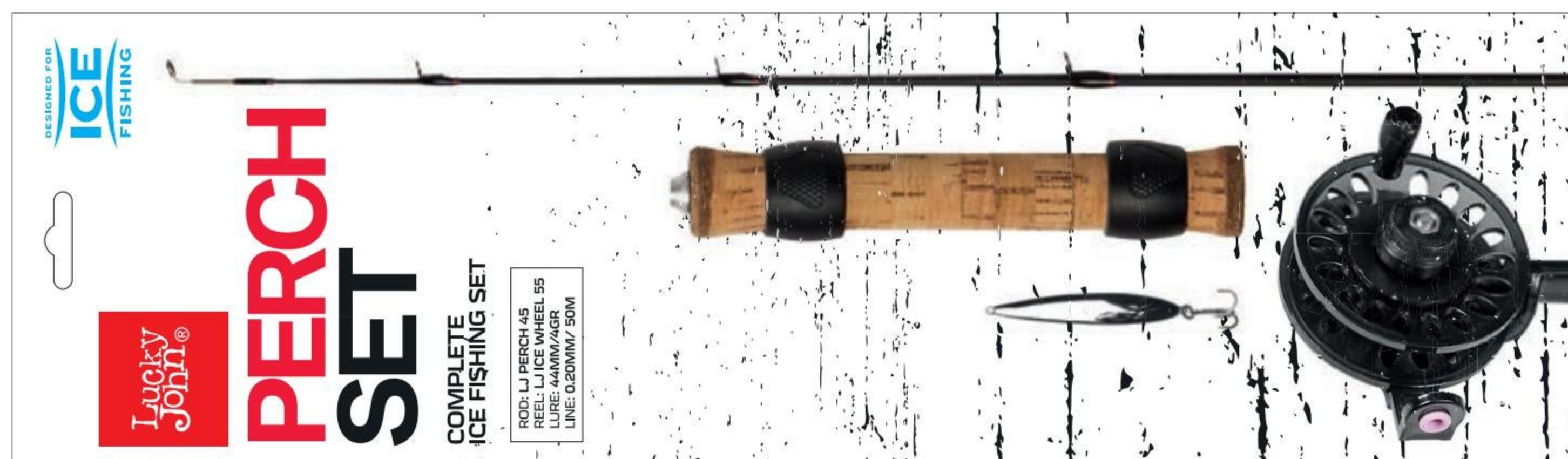

ITEM NO.	ROD			DIAM. (MM)	LINE		LURE		
	LENGTH (CM)	TRANSP. LENGTH (CM)	WEIGHT (G)		LENGTH (M)	TEST (KG)	WEIGHT (G)	LENGTH (MM)	TREBLE HOOK (Nº)
LJ121SET	45	45	44	0,20	50	3,20	4	44	8

**NEW**

## ICE FISHING ROD SET **LUCKY JOHN BALANCED LURE SET**

The winter rod set includes rod, line and balanced lure. The set created for catching medium-sized predatory fish. The very lightweight one section rod comes with the Lucky John MGC line (0.16 mm diameter; 30 m) and the popular Lucky John balanced lure CLASSIC 4, color 12HRT. The blank of the graphite rod is highly sensitive, and you will feel even a slightest bite. The catchy model of the balanced lure will ensure the maximum of bites, and the reliable fishing line will allow you to fish without worrying about annoying breaks. An excellent choice for both – beginners and experienced anglers.



ITEM NO.	ROD			DIAM. (MM)	LINE		BALANCED LURES		
	LENGTH (CM)	TRANSP. LENGTH (CM)	WEIGHT (G)		LENGTH (M)	TEST (KG)	WEIGHT (G)	LENGTH (MM)	TREBLE HOOK (Nº)
LJ114SET	41	41	20	0,16	30	3,25	6	40	12

## SPINNING REEL LUCKY JOHN SCANDI II

**NEW**

A modern spinning reel for winter fishing. A high-quality friction brake provides smooth braking when fishing in cold weather. The reliable and ergonomic handle makes fishing as comfortable as possible. The power of the reel is quite enough to cope with a significant trophy.

- Front drag FD
- 4 ball bearings
- 1 roller bearing
- Instant anti-reverse
- Reel body and rotor - graphite
- Spool - shallow aluminum

**Handle**

- Aluminum
- Possibility of right/ left placement
- Ergonomic rubber knob



ITEM NO.	SIZE	BB	RB	M/MM	WEIGHT (G)	LOADING ON FRICTIONS (KG)	GEAR RATIO
LJOSC05-08FD	800	4	1	180/0,16	160	4,8	5,2 : 1

## MULTIPLIER REEL LUCKY JOHN BP VIB

**NEW**

Multiplier reel for ice fishing rods. The reel is installed from the bottom of the rod handle, like regular spinning reel, under the left hand. A specific feature of this reel is the extended leg, which gives more freedom for the fingers when holding the fishing rod. The reel also has handy trigger key for free fishing line dropping, which is located directly under the index finger.

- 3 ball bearings
- 1 roller bearing
- Left hand
- Instant anti-reverse
- Quality brass gears
- Friction braking system STAR DRAG
- Mechanic drag system
- Long leg for fishing with gloves
- Graphite body and spool
- Balanced handle
- Ergonomic rubber knob



ITEM NO.	BALL BEARINGS	ROLLER BEARING	M/MM	DIAM. SPOOL (MM)	WEIGHT (G)	GEAR RATIO
LJPV04-MM	3	1	70/0,23	60	211	3,6 : 1

## LUCKY JOHN MULTIPLIER REEL ICE MULTIK

Tiny multiplier reel specifically designed for ice fishing rods.

- ▶ Instant anti-reverse
- ▶ Mechanic drag system
- ▶ Aluminium body
- ▶ Plastic spool
- ▶ Aluminium handle
- ▶ Plastic handle knobs



ITEM NO.	(M/MM)	SPOOL Ø (MM)	WEIGHT (G)	GEAR RATIO
LJ-3010	140/0,18	15	85	3,6 : 1

## LUCKY JOHN MULTIPLIER REEL **MAIKO**

- ▶ 4 ball bearings
- ▶ 1 roller bearing
- ▶ Instant anti-reverse
- ▶ MECHANIC DRAG system
- ▶ Friction braking system STAR DRAG
- ▶ Graphite body and spool
- ▶ Quality brass gears
- ▶ Fast detachable spool
- ▶ Handle: balanced Ergonomic rubber handle



ITEM NO.	WEIGHT (G)	SPOOL Ø (MM)	BALL BEARINGS	ROLLER BEARING	GEAR RATIO
LJ3055	152	55	4	1	2,6 : 1
LJ3065	162	65	4	1	2,6 : 1

## LUCKY JOHN ICE FISHING REEL **ICE WHEEL**

- ▶ 1 ball bearing
- ▶ Friction brake system
- ▶ Extended «leg»
- ▶ Durable plastic insert for line passing



LJ-1155



LJ-1160

ITEM NO.	SPOOL Ø (MM)	WEIGHT (G)
LJ-1155	55	64,3
LJ-1160	60	68,7



## LUCKY JOHN ICE FISHING SEAT BOX

- Solid plastic fishing box
- Adjustable shoulder belt
- Cover fixings from both sides
- Handle in the cover
- Capacious internal sections
- Removable container for fishing rods
- Removable container for lures



ITEM NO.	SIZE (CM)	HEIGHT (CM)
LJ2050	38 x 26	31,5

## WINTER ROD BAG

**NEW**

### LUCKY JOHN 41 x 29 x 5 CM

Durable and reliable book shape bag for storing and transporting winter fishing rods. Ten «pockets» allow you to place equipped fishing rods (such as «balalaika», etc.). The bag has zipper and comfortable handles.



ITEM NO.	SIZE (CM)	DESCRIPTION
LJ4129-005RB	41x29x5	«pockets» for rods

## LUCKY JOHN LURE CASES



ITEM NO.	SIZE (CM)
LJ8010	13,8 x 9,5 x 1,7

## LUCKY JOHN MONOFILAMENT FISHING LINE MICRON

The assortment of next generation fishing line includes minimal diameters; therefore it is well-suited for winter fishing. The line has special protective coating, due to which it has the following properties: it has high strength, does not interact with water –

does not lose its mechanical properties for a long time, retains its parameters in freezing temperatures and is practically invisible to the fish. The line is produced in Japan using raw materials of the highest quality and latest technologies.

- ▶ high strength
- ▶ high durability
- ▶ perfectly calibrated diameters and smooth surface
- ▶ low “memory”
- ▶ high knot strength

ITEM NO.	DIAM. (MM)	LENGTH (M)	COLOR	Q-TY IN A PACK
LJ4001-006	0,066	50	transparent	ind. pack.
LJ4001-008	0,085	50	transparent	ind. pack.
LJ4001-010	0,108	50	transparent	ind. pack.
LJ4001-012	0,121	50	transparent	ind. pack.

LINE TEST					
Diameter, MM	0,066	0,085	0,108	0,121	0,153
Size, #	0,15	0,25	0,4	0,5	0,8
Test (kg)	0,40	0,67	1,05	1,31	2,05



## LUCKY JOHN MONOFILAMENT FISHING LINE MGC

Modern monofilament ice fishing line. Made in Japan with application of the high-grade material and the innovative technologies, it preserves its strength and elasticity even at -50°C.

- ▶ the highest strength
- ▶ high abrasion resistance
- ▶ ideal calibration
- ▶ smooth surface
- ▶ lack of “memory”
- ▶ high knot strength

LINE TEST									
Diameter, MM	0,06	0,08	0,10	0,12	0,14	0,16	0,18	0,20	
Test (kg)	0,55	0,88	1,45	1,75	2,55	3,25	3,95	4,68	

ITEM NO.	DIAM. (MM)	LENGTH (M)	COLOR	Q-TY IN A PACK
LJ4000-006	0,06	30	transparent	ind. pack.
LJ4000-008	0,08	30	transparent	ind. pack.
LJ4000-010	0,10	30	transparent	ind. pack.
LJ4000-012	0,12	30	transparent	ind. pack.
LJ4000-014	0,14	30	transparent	ind. pack.
LJ4000-016	0,16	30	transparent	ind. pack.
LJ4000-018	0,18	30	transparent	ind. pack.
LJ4000-020	0,20	30	transparent	ind. pack.





## ICE SCOOP LUCKY JOHN 51 CM **NEW**

Scoop for extracting ice pieces from the fishing hole. The scoop mesh is made of stainless steel and screwed into an aluminum handle. For a more comfortable use on the handle there is an EVA holder, which does not absorb water and does not cool the hand.



ITEM NO.	LENGTH (CM)	DIAM. ICE SCOOP (CM)	DESCRIPTION
LJ11-040MS	51	11	mesh; ind. package

## POWDER HAND WARMERS

Open the package and shake it several times. Put it into your pocket or into mittens. In 5–10 minutes as a result of chemical reaction the warmer will heat up. Depending on the air temperature and heat loss the operative temperature of the warmer is 40–60 °C, effective operation time up to 6 hours. Active ingredients of the heater – iron, water, cellulose, vermiculite, activated carbon and salt. All ingredients are non-toxic and odour free. The warmer is disposable.



ITEM NO.	DESCRIPTION	SIZE (CM)
H-5027	active for 6 hours	9,5 x 5
H-5028	active for 6 hours	13 x 10

## ICE SCOOP



ITEM NO.	DESCRIPTION
ZK-400	wooden handle

## SAFTY STICKS

Safety sticks are essential fishing equipment. Going out on thin ice without them is very dangerous! Safety sticks are worn around the neck and stay assembled on the angler's chest during fishing. Should the angler fall under the ice he must open the safety sticks and take one in each hand. Then he must thrust the sharp spikes into the ice to get hold of it. Next thrust the spikes into the ice in front of him, he must crawl out onto a firm section of ice.



ITEM NO.	DESCRIPTION
H-10902	with attached cord

# BASARA **VIB S**



## WOBBLER LUCKY JOHN PRO SERIES BASARA VIB S

These sinking plastic wobblers are effective for fishing large predators, especially pike perch. When pulling, the wobbler vibrates and attracts predators from a large distance.

Depending on the fixation place of the fastener the game of the bait will be slightly different. Basara VIB may be used for different fishing techniques and in various waters. The lure has quality Japanese fittings, and it is available in one sizes – 90 mm.

ITEM NO.	COLOUR (****)	WEIGHT (G)	LENGTH (MM)	Q-TY IN A PACK (PCS.)
LJBAV90-***	124; 137; 147; 155; 201; 311; 319	28	90	ind. pack



# **VIB**



## WOBBLER LUCKY JOHN PRO SERIES VIB

Lucky John VIB – vibrating jigging lure initially profiled for open water fishing but in recent years with great success, has become popular for ice fishing as a lure without acoustic effect.

The VIB's balanced weight system is key to its unique vibration, and with a smooth pull the lure begins to vibrate, imitating prey and attracting predators from long distances. Then, with a steady drop, the lure swims and darts like wounded prey triggering crushing strikes.

ITEM NO.	COLOUR (****)	WEIGHT (G)	LENGTH (MM)	Q-TY IN A PACK (PCS.)
LJVIB58-***	101; 137; 138; 140; 211; 319; 408; 707	10	58	ind. pack



# LUCKY JOHN BALANCED LURE

Balanced lures of LUCKY JOHN Trademark have already won popularity among the best ice lures in many countries across the world. They have shown themselves to the best advantage according to many anglers. Currently the LUCKY JOHN balanced lures resemble natural prey items – the fry so much that bite is virtually guaranteed at any time, irrespective of activity of fish. An ideal game of the lure, imitating an escaping fry, allows not only luring a predator immediately under the hole, but also attracting it from a longer distance. Besides, the excellent balancing of the lure allows harvesting a maximum large water area under the hole. Several models, rich variety of colours and sizes allow matching necessary lure in order to catch more fish and to enjoy fishing as much as possible! LUCKY JOHN balanced lures model CLASSIC and FIN are equipped with strong and sharp KAMASAN hooks.



## Additional designations in marking

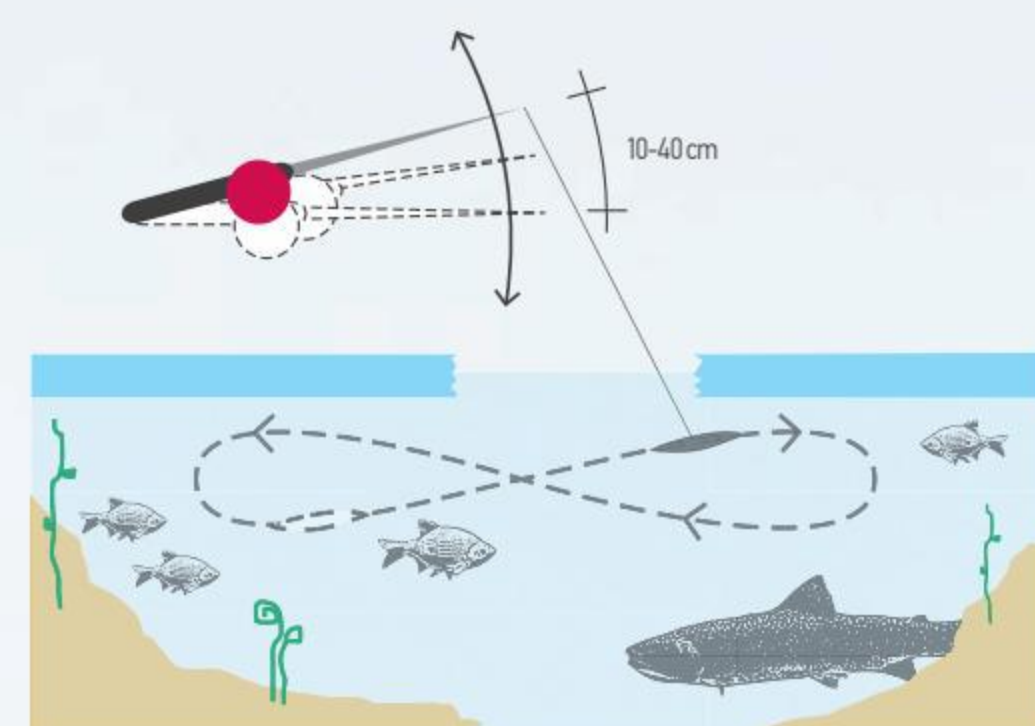

Particularly strong fastening of PC tails that come in two colours



KAMASAN strong and sharp Japanese hooks



All lures are individually packed, irrespective of the size, they come completed with a treble hook with a coloured drop.



## BALANCED LURE **LUCKY JOHN BALTIC**

The Lucky John Baltic is a compact, weighted jigging minnow designed to fish at depths, with or without current. Available in 40 mm, 50 mm and 60 mm sizes, these three models weigh 10 grams, 22 grams, and 46 grams respectively; the smaller size Baltic has been a go to perch bait for anglers worldwide, with the larger models being a particular favored lure for deep water walleyes.

The Baltic is available in clear or red options for the rear tail stabilizer, and are also available in attention grabbing holographic patterns that stand out in deep or stained water. The fierce "samurai" detailed finish is augmented by Japanese Kamasan hooks front and back, along with a sticky sharp beaded VMC hook on the bottom.



ITEM NO.	COLOUR (****)	WEIGHT (G)	LENGTH (MM)	HOOK (NO.)	Q-TY IN A PACK (PCS.)
61401-***	12HRT; 24; 26RT; 45H; 47H; 53; 103; 114; 201; 301RT	10	40	12	ind. pack
61501-***	12HRT; 24; 26RT; 45H; 47H; 53; 103; 114; 201; 301RT	22	50	10	ind. pack
61601-***	12HRT; 24; 26RT; 53; 103; 114; 201; 301RT	46	60	8	ind. pack

## BALANCED LURES **LUCKY JOHN NORDIC**

NORDIC is heavy, compact, ideally Balanced lure, specially designed for the deep-water lakes and rivers with a fairly strong currents. The lure is available in three sizes – 40, 50, 60 mm and accordingly – 12, 21 and 36 g weight. Classic form of the lure looks like a small fish and therefore attracts the attention of a predator.



ITEM NO.	COLOUR (****)	WEIGHT (G)	LENGTH (MM)	HOOK (NO.)	Q-TY IN A PACK (PCS.)
51401-***	12HRT; 13H; 15H; 29; 40H; 37H; 41H; 47H; 103; 114; 301RT	12	40	12	ind. pack
51501-***	12HRT; 13H; 15H; 29; 40H; 37H; 41H; 47H; 103; 114; 301RT	21	50	10	ind. pack
51601-***	12HRT; 13H; 15H; 29; 40H; 37H; 41H; 47H; 103; 114; 301RT	36	60	8	ind. pack

## BALANCED LURES **LUCKY JOHN CLASSIC**

The most popular among anglers model. A hard tail of the lure makes the lure a wider and quicker play. During stirring of the predators you can achieve the best results thanks to these lures. Please note, there are two colours of the tail available in assortment – red and transparent. All lures are individually packed, irrespective of the size, they come completed with a treble hook with a coloured drop.



ITEM NO.	COLOUR (****)	HOOK (NO.)	WEIGHT (G)	LENGTH (MM)	Q-TY IN A PACK (PCS.)
81301-****	12HRT; 13H; 15H; 20; 26RT; 31RT; 45H, 53	14	5	30	ind. pack
81401-****	12HRT; 13H; 15H; 20; 26RT; 31RT; 45H, 53	12	6	40	ind. pack
81501-****	12HRT; 13H; 15H; 20; 26RT; 28; 31RT; 45H, 53	12	13	50	ind. pack
81601-****	12HRT; 13H; 15H; 20; 26RT; 31RT; 45H, 53	10	16	60	ind. pack

## BALANCED LURES **LUCKY JOHN FIN**

The FIN balanced lures have a flatter body in section than the CLASSIC model. Therefore the “Fins” harvest a larger underwater area. The FIN lures come in three sizes, out of which you can easily pick up a necessary size for fishing a perch, a pike or a pike-perch, as well for different levels of luminosity under water. All lures are individually packed and come completed with treble hook and coloured drops.

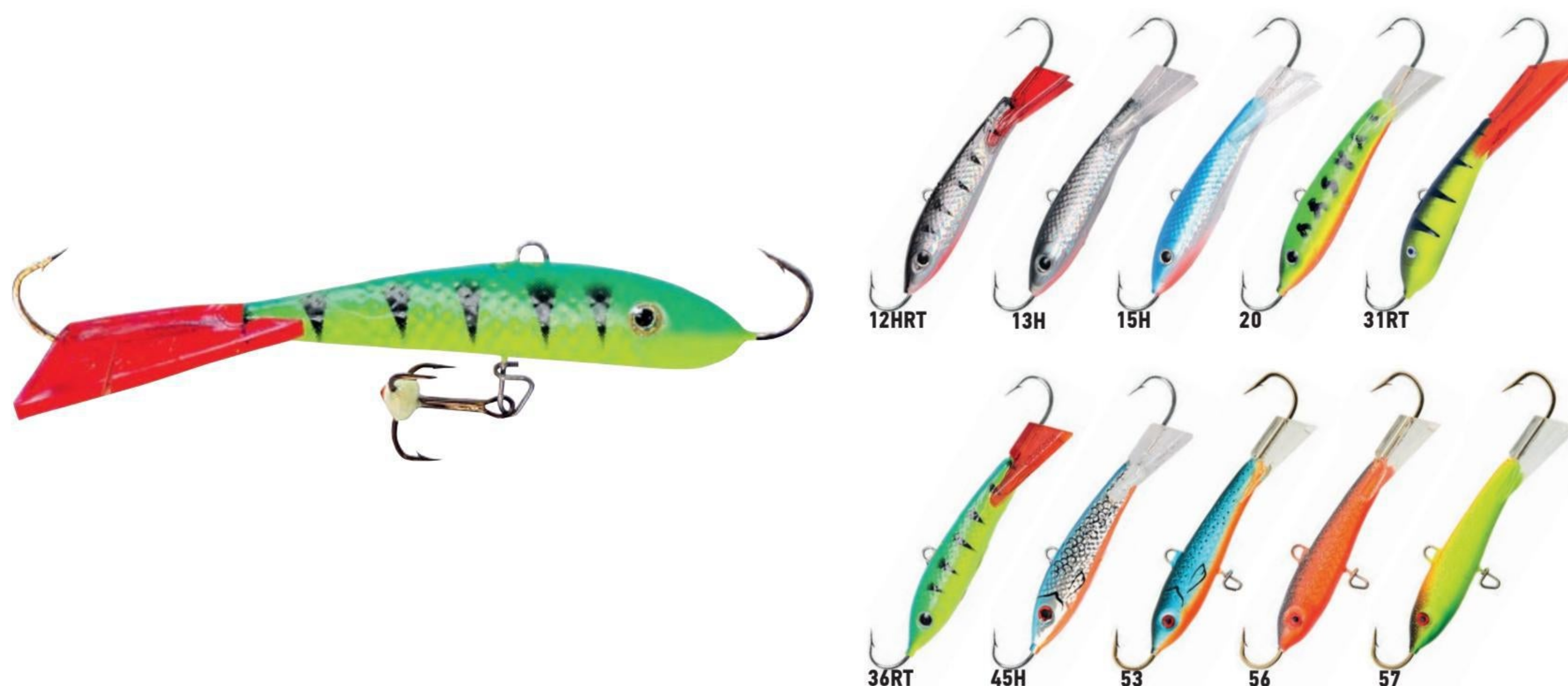

ITEM NO.	COLOUR (****)	HOOK (NO.)	WEIGHT (G)	LENGTH (MM)	Q-TY IN A PACK (PCS.)
71313-****	12HRT; 13H; 15H; 20; 31RT; 36RT; 45H; 53; 56; 57	14	4	40	ind. pack
71413-****	12HRT; 13H; 15H; 20; 31RT; 36RT; 45H; 53	12	11	60	ind. pack
71513-****	12HRT; 13H; 15H; 20; 31RT; 36RT; 45H; 53; 56; 57	12	20	70	ind. pack

## VERTICAL LURE WITH TREBLE HOOK LUCKY JOHN "S-1/2/3"



ITEM NO.	COLOUR (*)	LENGTH (MM)	WEIGHT (G)	DEPTH (M)	LINE Ø (MM)	FISH	Q-TY IN A PACK (PCS.)
8274-*	S; G; C	31	1,5	Up to 3	0,10-0,12	perch	ind. pack
8275-*	S; G; C	42	3	Up to 4	0,12-0,14	perch	ind. pack
8276-*	S; G; C	55	6	Up to 7	0,14-0,18	perch, pike	ind. pack

## VERTICAL LURE WITH CHAIN AND TREBLE HOOK LUCKY JOHN "S-2-Z/S-3-Z"



ITEM NO.	COLOUR (*)	LENGTH (MM)	WEIGHT (G)	DEPTH (M)	LINE Ø (MM)	FISH	Q-TY IN A PACK (PCS.)
82752-*	S; G; C	42	4	Up to 4	0,12-0,14	perch, pike	ind. pack
82762-*	S; G; C	55	7	Up to 7	0,14-0,18	perch, pike	ind. pack

## LUCKY JOHN DOUBLE BLADE 45

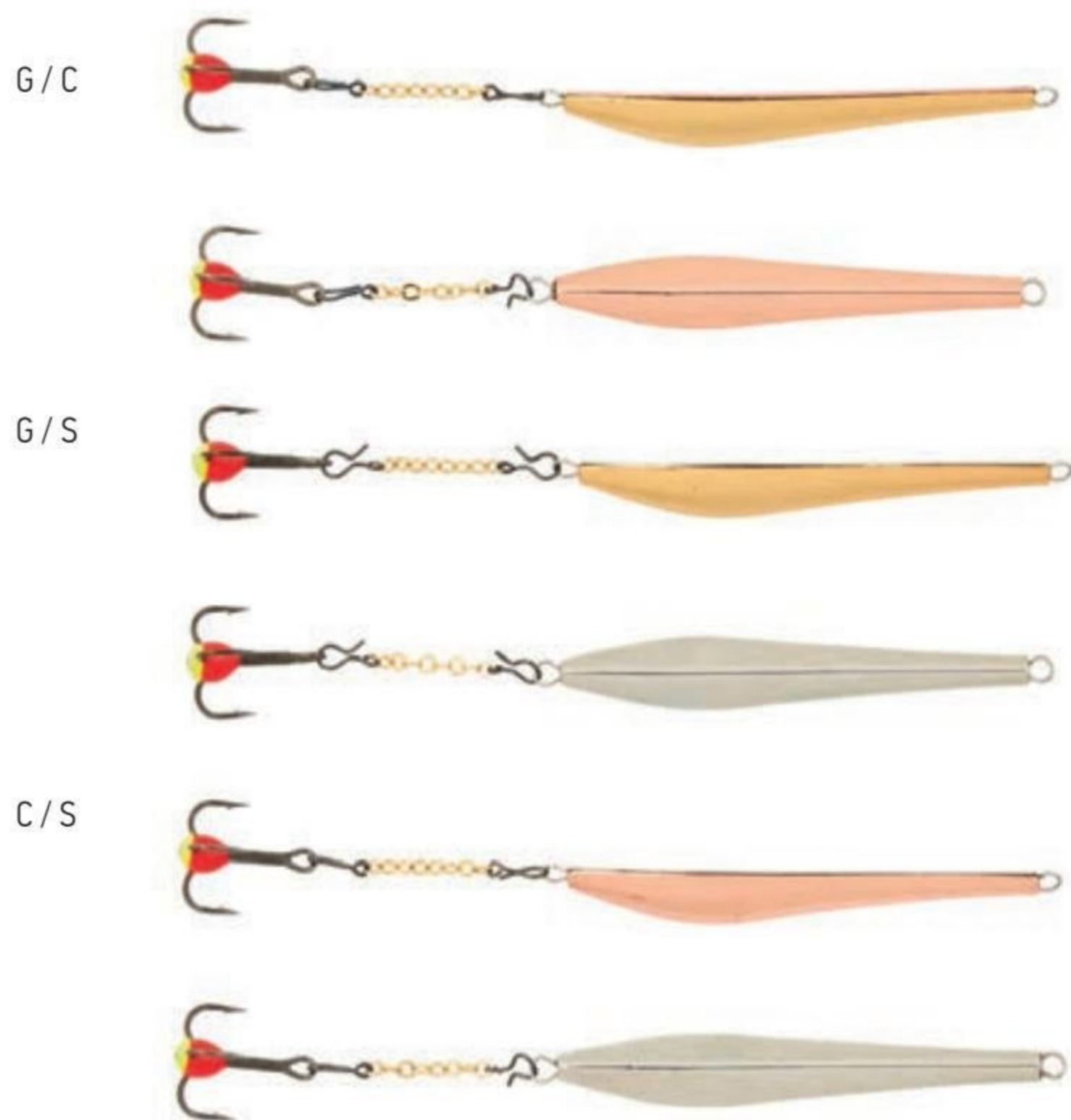

ITEM NO.	COLOUR (*)	LENGTH (MM)	WEIGHT (G)	DEPTH (M)	LINE Ø (MM)	FISH	Q-TY IN A PACK (PCS.)
LJDD45-*	CS; GC; SG	40	4	до 4	0,12-0,14	perch	ind. pack
LJDD55-*	CS; GC; SG	50	6	до 6	0,14-0,18	perch, pike	ind. pack
LJDD65-*	CS; GC; SG	60	11	3-9	0,18-0,22	perch, pike	ind. pack

## LUCKY JOHN BEADED TREBLES



ITEM NO.	SIZE	COLOUR (**)	Q-TY IN A PACK (PCS.)
LJ99080-**	08	01; 02; 04; 05; 10; 11; 12; 13 14	10
LJ99100-**	10	01; 02; 03; 04; 05; 10; 11; 12; 13 14	10
LJ99120-**	12	01; 02; 03; 04; 05; 10; 11; 12; 13 14	10
LJ99140-**	14	01; 02; 03; 04; 05; 10; 11; 12; 13 14	10

VERICAL LURES WINTER **LUCKY JOHN «PEIP»**



ITEM NO.	MODEL	COLOUR	LENGTH (MM)	WEIGHT (G)	Q-TY IN A PACK (PCS.)
LJPE50-***	PEIP	A, BI, PG	50	9,0	ind. pack
LJPE60-***	PEIP	A, BI, C, G, PG, RG, RW, S	60	11,3	ind. pack
LJPE70-***	PEIP	RG, RW, S	70		ind. pack

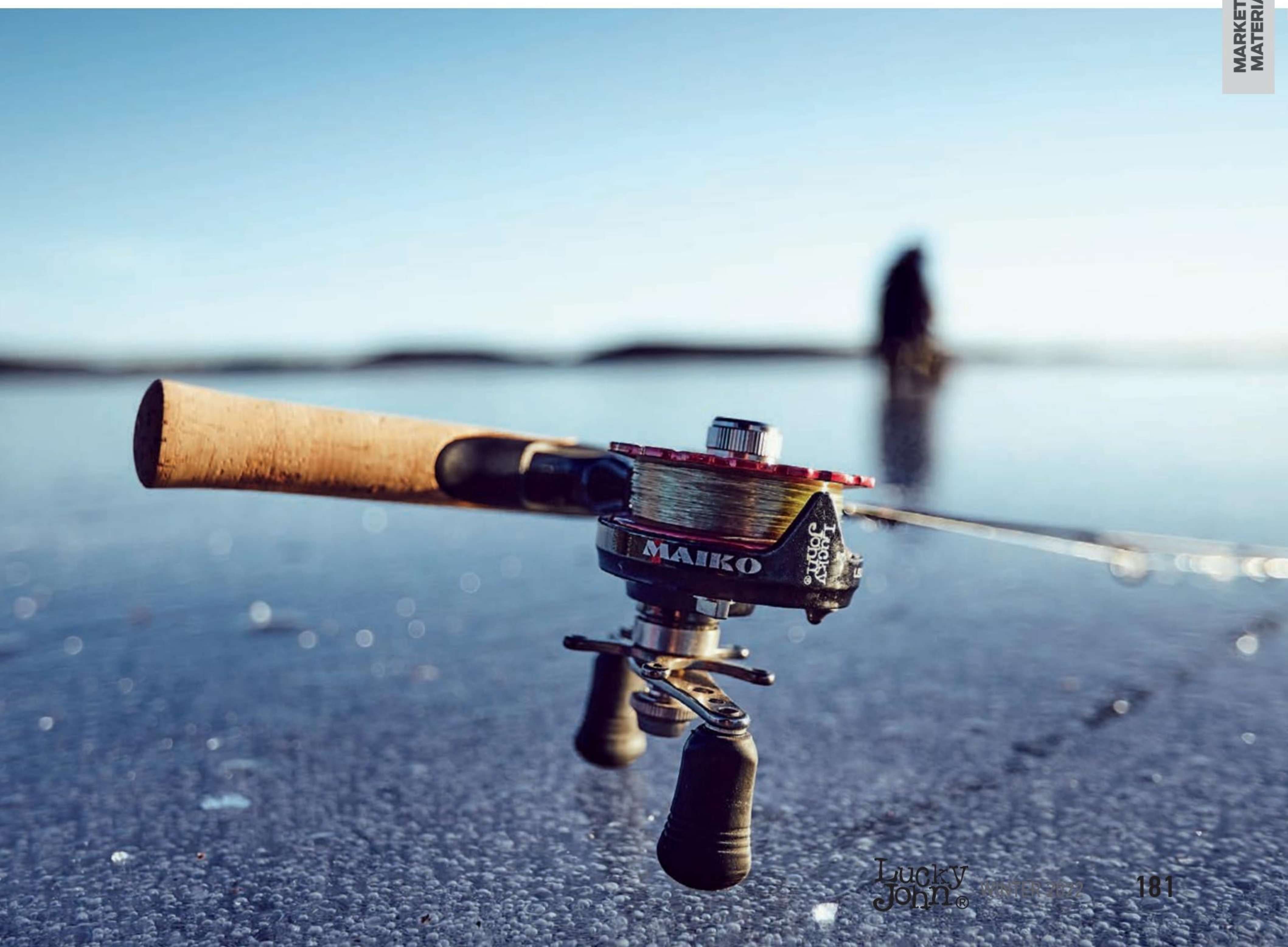



## TUNGSTEN MORMYSHKAS LUCKY JOHN

A range of efficient mormyshka style tungsten ice jigs offered by Lucky John will not disappoint any ice fishing enthusiast. All mormyshkas are offered in individual packaging.



### TUNGSTEN MORMYSHKA WITH HOLE LUCKY JOHN "BALL"





SIZE	030	040	050
ø (MM)	3,0	4,0	5,0
Real size (look)			
Weight (g)	0,22	0,51	1,01
Hook size	18	16	14

ITEM NO.	SIZE	COLOUR (**)	Q-TY IN A PACK (PCS.)
LJB01030-**-**	030	01, 02, 03	ind. pack
LJB01040-**-**	040	01, 02, 03	ind. pack
LJB01050-**-**	050	01, 02, 03	ind. pack

  
**HAYABUSA**

### TUNGSTEN FACET MORMYSHKA WITH AN EYELET LUCKY JOHN "BALL"





SIZE	040	050
ø (MM)	4,0	5,0
Real size (look)		
Weight (g)	0,58	1,18
Hook size	16	14

ITEM NO.	SIZE	COLOUR (**)	Q-TY IN A PACK (PCS.)
LJB02040-**-**	040	01, 02, 03, 04	ind. pack
LJB02050-**-**	050	01, 02, 03	ind. pack

  
**HAYABUSA**

### TUNGSTEN MORMYSHKA WITH AN EYELET AND COATING LUCKY JOHN "DROP"





SIZE	030	040	050
ø (MM)	3,0	4,0	5,0
H (MM)	5,3	7,0	7,8
Real size (look)			
Weight (g)	0,42	0,79	1,47
Hook size	16	14	12

ITEM NO.	SIZE	COLOUR (**)	Q-TY IN A PACK (PCS.)
LJB09030-**-**	030	16; 17; 18; 19; 20; 21	ind. pack
LJB09040-**-**	040	20; 21	ind. pack
LJB09050-**-**	050	16; 17; 18; 19; 20; 21	ind. pack

  
**HAYABUSA**

### TUNGSTEN MORMYSHKA WITH AN EYELET LUCKY JOHN "BALL"







SIZE	040	050	060
ø (MM)	4,0	5,0	6,0
Real size (look)			
Weight (g)	0,58	1,15	1,97
Hook size	16	14	12

ITEM NO.	SIZE	COLOUR (**)	Q-TY IN A PACK (PCS.)
LJ04040-**-**	040	01, 02, 03	ind. pack
LJ04050-**-**	050	01, 02, 03	ind. pack
LJ04060-**-**	060	01, 02, 03	ind. pack

  
**HAYABUSA**

### TUNGSTEN MORMYSHKA WITH AN EYELET LUCKY JOHN "DROP"



SIZE	030	040	050	060
ø (MM)	3,0	4,0	5,0	6,0
H (MM)	5,3	7,0	7,8	10,5
Real size (look)				
Weight (g)	0,42	0,79	1,47	2,57
Hook size	16	14	12	10



ITEM NO.	SIZE	COLOUR (**)	Q-TY IN A PACK (PCS.)
LJB09030-**-**	030	02	ind. pack
LJB09040-**-**	040	01; 02; 03	ind. pack
LJB09050-**-**	050	01; 02; 03	ind. pack
LJB09060-**-**	060	01; 02; 03	ind. pack

  
**HAYABUSA**



## TUNGSTEN MORMYSHKA WITH AN EYELET AND FLUORESCENCE DYE **LUCKY JOHN "NYMPH"**





SIZE	040	050
ø (MM)	4,0	5,0
H (MM)	7,2	9,5
Real size (look)		
Weight (g)	0,79	1,47
Hook size	14	12



ITEM NO.	SIZE	COLOUR (**)	Q-TY IN A PACK (PCS.)
LJB15040-**-**	040	42; 44	ind. pack
LJB15050-**-**	050	41; 42; 43; 44	ind. pack

## TUNGSTEN MORMYSHKA WITH AN EYLET **LUCKY JOHN "BANANA"**



SIZE	030	035
ø (MM)	3,0	3,5
H (MM)	10,6	12,5
Real size (look)		
Weight (g)	0,55	0,75
Hook size	12	10



ITEM NO.	SIZE	COLOUR (**)	Q-TY IN A PACK (PCS.)
LJB12030-**-**	030	01; 02	ind. pack
LJB12035-**-**	035	02	ind. pack

## WINTER SOFT LURES LUCKY JOHN

### ARTIFICIAL BLOODWORM LUCKY JOHN **EXTRA BLOOD WORM PACKAGE**

Artificial bloodworm Lucky John Extra Blood Worm with its bright colour, long-lasting scent and flavour attracts the fish no worse than the real one. During winter, while passing from one ice-hole to another, the artificial bloodworm not only will not freeze (as would real bloodworm), but also will wag its tail just as lively even after repeatedly being swallowed by a fish.



ITEM NO.	DESCRIPTION	COLOUR (****)	Q-TY IN A PACK (PCS.)
140201-001	Artificial bloodworm	red	200
140201-002	Artificial bloodworm XL	red	160

### ARTIFICIAL MAGGOT LUCKY JOHN **MAGGOT PACKAGE**

Artificial maggot Lucky John Maggot – excellent flavour and scent close to real. It has a number of advantages in comparison to the real maggot: it surpasses the real maggot in attractiveness, does not freeze at low temperatures, holds on a hook for a much longer time, does not pupate, has unlimited shelf life and is always at hand while fishing.



ITEM NO.	DESCRIPTION	LENGTH (MM)	COLOUR	Q-TY IN A PACK (PCS.)
140202-033	Maggot Lucky John Maggot	12	phosphoric	30w





**NOREFIN**<sup>®</sup>

**ULTIMATE  
PROTECTION**

LUCKY JOHN  
SUMMER

FEEDER  
CONCEPT

NORFIN  
SUMMER

LUCKY JOHN  
WINTER

NORFIN  
WINTER

MARKETING  
MATERIALS

**NOREFIN**<sup>®</sup>

WINTER 2012

185

**NOR FLEECE**

Dry



- ▶ perfectly draws out moisture
- ▶ two-layered structure of the fabric
- ▶ comfortable in contact with the skin
- ▶ dries quickly

**NOR FLEECE**

Micro

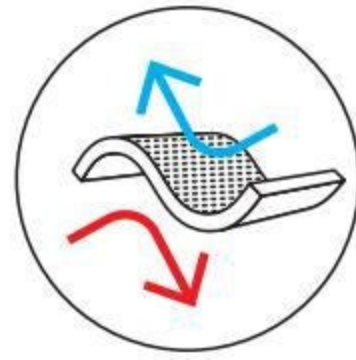

- ▶ high «breathability»
- ▶ pleasant to the touch
- ▶ retains warmth of the body
- ▶ dries quickly

**NOR FLEECE**

Stretch

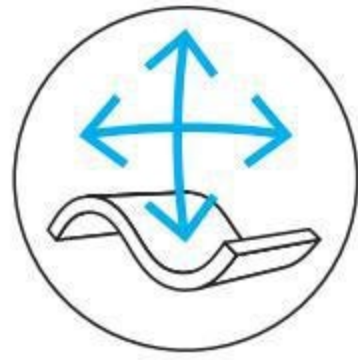

- ▶ elastic fabric that can be stretched in 4 directions
- ▶ durable surface
- ▶ good «breathability»
- ▶ dries quickly

**NOR FLEECE**

Thermo

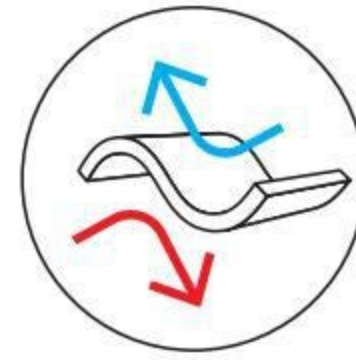

- ▶ durable material
- ▶ retains warmth of the body
- ▶ high «breathability»
- ▶ dries quickly

**NOR FLEECE**

Thermo +

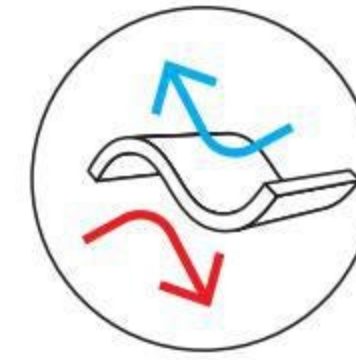

- ▶ retains warmth of the body
- ▶ protects against wind and cold
- ▶ «breathable» material
- ▶ pleasant to the touch



**TEFLON** – is the material covered with layer of **DUPONT® TEFLON®** to ensure moisture-repellant features.



**NEOPRENE** – leaf thermal insulation on the basis of light foam rubber. Multiple air bubbles ensure heat retention and provide buoyancy properties of the material.



**DOWN** – insulation made of natural down having excellent features: light weight and high thermal insulation characteristics, small transportation volume and extended period of use. These features are ensured thanks to its structure: the lightest feathers fill-in the whole volume and is easy to compress.



**LEATHER** – high quality leather.

## IMPLEMENTS

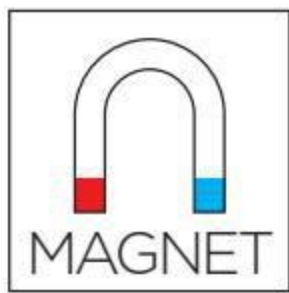

**MAGNET** – fastening with magnet.



**YKK** is leader in zipper production, offering no-compromise quality. **YKK** zippers, which are made in Japan, can be found from the earth's oceans and into space, every environment known to man.

## TECHNICAL TERMS



**TEMPERATURE** – the minimum recommended threshold for use.



**BREATHABLE** – Measured in g / m<sup>2</sup> for 24 hours.



**WATERPROOF** – index number describing the waterproof feature of the material.

## PURPOSE



**FISHING** – clothing designed for fishermen.



**SNOWMOBILE** – clothing suitable for use on snowmobile.



**HUNTING** – clothing designed for hunters.



**FLOATING** – buoyant suits, which help you to stay on the water and increase the safety. As insulation material is used buoyancy porous layer that provides buoyancy feature.

# MATERIALS AND TECHNOLOGIES OF NORFIN

## TECHNOLOGIES



**DUAL THERMAL SYSTEM** – insulation technology system that efficiently combines natural down and synthetic fiber. Balanced proportion of natural down and synthetics allows to reach heat-insulation and «breathing» features that can't be obtained using weather down or synthetics. Structurally the insulation consists of two layers: the inner layer – HOLLOFILL and the outer layer – down and feather.

- ▶ Doesn't pill – maintains the form during extended period of use
- ▶ Retains high heat-insulation features during extended period of use
- ▶ High «breathing» capacity
- ▶ Improved resistance to outer negative factors including high humidity.

## MATERIALS



**NORFIN SILENT MATERIAL** – Specially designed to disguise your appearance, **NORFIN SILENT MATERIAL** fabrics are practically noiseless, ensuring great freedom of movement.



### HEAT SYSTEM

Norfin Heat System is next step in comfort in extremely cold weather. System is powered by 2.1 amp or higher output Power-bank and is heating most exposed places on body – back and legs. Controlled with one-touch LED waterproof smart temperature controller with 3 heat settings.

It is safe low voltage system which can withstand moisture and even washing.

SETTING	LED COLOR	APPROX. TEMPERATURE °C	AVERAGE DURATION WITH 5 AH POWER-BANK
Low	Blue	38	6,5 h
Medium	White	45	4 h
High	Red	55	2 h

How it works:

1. Press and hold button for 2 sec. until the red color turns on (high temperature)
2. Click to switch to medium temperature – white color
3. Click to switch to low temperature – blue color
4. Change temperature setting by each click in cycle.
5. Press and hold for 2 sec. to turn off.



**NORTEX BREATHABLE** – is a technologically highly developed multi-layer material ensuring great breathability at the same time being completely wind and waterproof, protecting you from bad weather. **NOR-TEX BREATHABLE** perfectly holds the insulation, warm air and retains the warmth of the body. Because of the breathability of the material, clothing made of **NOR-TEX BREATHABLE** is pleasant and comfortable. When moving actively the excess moisture and sweat are discharged to the external layers of the fabric while the body warmth is retained due to its thermal insulation features.



**HOLLOFIL** – high technology insulation with hollow fibers developed by company DuPont, using the fiber with 4 hollow holes that allows the material to retain warmth without extra weight. This material regains its features after compression, it is compact and soft. Easy to wash and antiallergenic.



**THINSULATE** – synthetic insulation manufactured by the company with the same name. The insulation consists of micro fibers able to hold more air in smaller volume, therefore it has better warmth retaining capacity. The insulation is air-proof and doesn't absorb moisture. It retains its features after washing and dry-cleaning.



**WINDPROOF** – «breathing» material with PU membrane, protects from wind, cold weather and moisture.



**THERMO GUARD** – modern high technology synthetic insulation on the base of polyester micro fibers. It holds the air thanks to its porous structure thus ensuring warmth retaining, antiallergenic and doesn't absorb moisture.



## WINTER SUIT NORFIN EXTREME 5

Functional 3 in 1 winter suit made of high quality, breathable and waterproof material NORTEX BREATHABLE, features a removable inner jacket and will keep you warm and comfortable at temperature as low as -45°C. The inner jacket has a warm HOLLOFIL insulation and features a modern design, therefore it can be used also on its own in the mid-season. Removable inner jacket. Versatile costume for different weather conditions. Extra long zipper on the sides of bibs

### JACKET

- ▶ Hood with visor
- ▶ High collar with fleece lining
- ▶ Two-way open-end zipper with protective flap
- ▶ Drawstring to tighten the jacket's lower part
- ▶ Hand warming pockets
- ▶ Two chest pockets and one inner pocket with zippers
- ▶ Two side pockets with flaps
- ▶ Adjustable outer sleeve cuff's
- ▶ Reinforced shoulder and elbow area
- ▶ Reflective elements
- ▶ Taped seams

### INNER JACKET

- ▶ HOLLOFIL insulation
- ▶ Two side pockets with zippers
- ▶ Inner Pocket with zipper

### BIB AND BRACE

- ▶ Length-adjustable suspenders
- ▶ Two-way open-end zipper with protective flap
- ▶ Comfortable side pockets
- ▶ Chest pocket with zipper
- ▶ Zip-fasteners with flaps on trouser legs
- ▶ Reinforced knee and seat area
- ▶ Removable soft inserts on the knee and seat areas



WATERPROOFING  
**12000 MM**

MATERIAL  
**NORTEX BREATHABLE**

BREATHABILITY  
**8000 G/M<sup>2</sup>/24 HOURS**

INSULATION  
**HOLLOFIL**

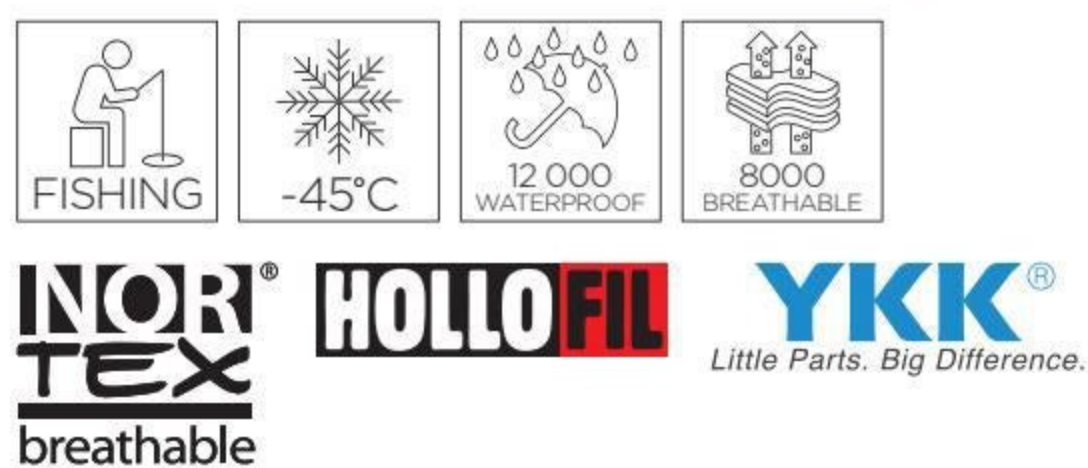

ITEM NO.	SIZE (****)	DESCRIPTION	COLOR
338002-****	M	jacket (2 in 1), bib and braces	black
338002-****	M-L	jacket (2 in 1), bib and braces	black
338003-****	L	jacket (2 in 1), bib and braces	black
338003-****	L-L	jacket (2 in 1), bib and braces	black
338004-****	XL	jacket (2 in 1), bib and braces	black
338005-****	XXL	jacket (2 in 1), bib and braces	black



**NEW**

## WINTER SUIT NORFIN DISCOVERY 2 LE CAMO

Warmth and comfort ensured in temperatures down to -35°C.

### JACKET

- Glued seams
- Two-way open-end YKK zipper with protective flap
- Hood fastened with zipper
- Two-way adjustable hood
- Drawstring to tighten the jacket's waist
- Drawstring to tighten the jacket's lower part
- Handy inner and outer pockets
- Two outer pockets with waterproof zippers
- Warm cell phone pocket
- Adjustable outer sleeve cuff's
- Reinforced material on shoulder area
- Reflective security patches

### BIB AND BRACE

- Length-adjustable suspenders
- Chest pocket
- Two pockets with zippers
- Two large patch pockets
- Reinforced material on the knee and seat areas
- Inner snow gaiters



WATERPROOFING  
**8000 MM**

MATERIAL  
**NORTEX BREATHABLE**

BREATHABILITY  
**6000 G/M<sup>2</sup>/24 HOURS**

INSULATION  
**HOLLOFIL**

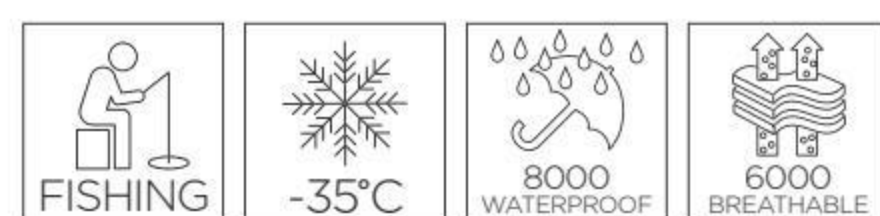

ITEM NO.	SIZE (****)	WEIGHT (KG)	DESCRIPTION	COLOR
452301-****	S	2,90	jacket, bib and braces	Camo
452302-****	M	3,02	jacket, bib and braces	Camo
452303-****	L	3,22	jacket, bib and braces	Camo
452304-****	XL	3,40	jacket, bib and braces	Camo
452305-****	XXL	3,54	jacket, bib and braces	Camo
452306-****	XXXL	3,72	jacket, bib and braces	Camo

# NORFIN **|||** LAYER SYSTEM

When you are fishing and it is probably the catch of your lifetime, we don't want even the smallest inconvenience to ruin it. That's why we make practical and functional clothing for anglers which will keep you warm in all conditions. Fishing can be a combination of active movement or long and patient waiting, so the clothing must be also universal or suitable for the activity. NORFIN clothing can be divided in layers with different functions – all this we call NORFIN LAYER SYSTEM.



## BASE LAYER

- Transfers moisture from the body
- Ensures breathability
- Maintains core temperature



## INSULATION LAYER

- Ensures warmth and insulation
- Transfers moisture to outside
- Maintains core temperature



## PROTECTIVE LAYER

- Protects from weather, rain and wind
- Keeps warmth to the body
- Transfers moisture to outside

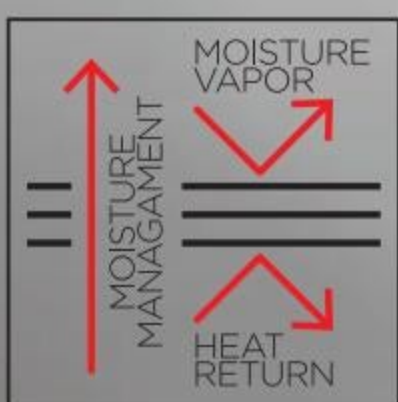

## NORFIN LAYER SYSTEM

- 1 Base layer – transfers moisture from the body
- 2 Insulation layer – ensures warmth and insulation and at the same time doesn't restrict your movement
- 3 Protective layer – protects from weather, rain and wind

[WWW.NORFIN.INFO](http://WWW.NORFIN.INFO)





## WINTER SUIT TORNADO

The NORFIN TORNADO developed ensuring warmth down to  $-30^{\circ}\text{C}$ . NORTEX BREATHABLE multi-layer material. Glued seams. Very light suit for such low temperatures. Adapted for snowmobiling. Special bag is provided for suit carrying and storing.

### JACKET

- ▶ Glued seams
- ▶ Special lining design with areas that improve moisture wicking
- ▶ Two-way open-end YKK zipper with protective flap
- ▶ Zip-off hood
- ▶ Drawstring to tighten the jacket at the waist and lower part
- ▶ Snow skirt
- ▶ Handy inside and outside pockets
- ▶ Warm cell phone pocket
- ▶ Additional cell phone pocket on sleeve for navigation
- ▶ Elastic, comfortable cuffs
- ▶ Adjustable outer sleeve cuff
- ▶ Reflective security patches

### BIB AND BRACE

- ▶ Length-adjustable suspenders
- ▶ Fleece lining
- ▶ Two outside pockets
- ▶ Reinforced knees and seat area
- ▶ Internal snow gaiters



**NORTEX**  
breathable

**3M Thinsulate**  
INSULATION

**YKK**  
Little Parts. Big Difference.®



WATERPROOFING  
**10 000 MM**

MATERIAL  
**NORTEX BREATHABLE**

BREATHABILITY  
**8000 G/M<sup>2</sup>/24 HOURS**

INSULATION  
**THINSULATE 3M**

ITEM NO.	SIZE (****)	WEIGHT (KG)	DESCRIPTION
408001-****	S		jacket, bib and braces
408002-****	M	3,40	jacket, bib and braces
408003-****	L	3,60	jacket, bib and braces
408003-****	L-L	3,60	jacket, bib and braces
408004-****	XL	3,80	jacket, bib and braces
408004-****	XL-L	3,80	jacket, bib and braces
408005-****	XXL	3,98	jacket, bib and braces

**NOREIN**<sup>®</sup>  
Verity Pro Gr

**NOREIN**<sup>®</sup>  
Verity Pro BL

**NEW**

## MULTI SEASON JACKET NORFIN VERITY PRO BLUE/GRAY

Multi-season jacket with a sporty design is suitable not only for fishing, but also for outdoor activities. The jacket is made of membrane material with high hydrostatic and breathability ratings. Modern and light HOLLOWFIL insulation is used to keep you warm at temperatures as low as -10°C.

### JACKETS

- Sealed seams
- Front YKK zipper
- Two-way adjustable hood
- Drawstring to tighten the jacket's lower part
- Three outer pockets with zippers
- Inner pocket with zipper
- Adjustable outer sleeve cuffs
- Elastic inner sleeve cuffs
- Reflective security prints



737001-\*

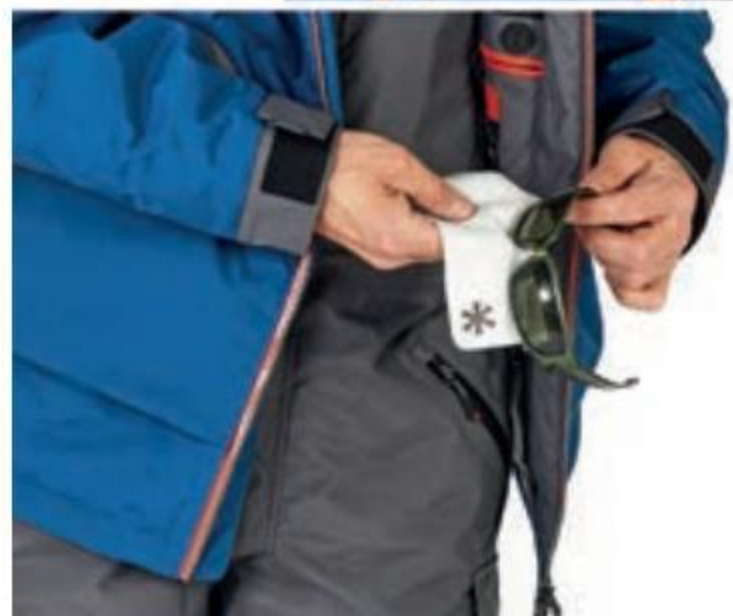

737101-\*

WATERPROOFING  
**12000 MM**

MATERIAL  
**NORTEX  
BREATHABLE**

BREATHABILITY  
**8000 G/M<sup>2</sup>/24  
HOURS**

INSULATION  
**HOLLOWFIL**



ITEM NO.	SIZE (****)	DESCRIPTION	COLOR
737***_*	S	jacket	gray or blue
737***_*	M	jacket	gray or blue
737***_*	L	jacket	gray or blue
737***_*	XL	jacket	gray or blue
737***_*	XXL	jacket	gray or blue
737***_*	XXXL	jacket	gray or blue



**NEW**

**MULTI SEASON BIB AND BRACE NORFIN  
VERITY PRO GRAY**

Multi season bibs designed not only for fishing but also for outdoor activities. The bibs are made of membrane material with high hydrostatic and breathability ratings. Modern and light HOLLOFIL insulation is used to keep you warm at temperatures as low as -10°C.

- BIB**
- Length-adjustable suspenders
  - Two side pockets
  - One chest pocket
  - Waterproof zippers
  - Elastic waistband



<p>WATERPROOFING <b>12000 MM</b></p>	<p>MATERIAL <b>NORTEX BREATHABLE</b></p>	<p>BREATHABILITY <b>8000 G/M<sup>2</sup>/24 HOURS</b></p>	<p>INSULATION <b>HOLLOFIL</b></p>
------------------------------------------	--------------------------------------------------	-------------------------------------------------------------------	---------------------------------------



ITEM NO.	SIZE (****)	DESCRIPTION	COLOR
747101-*	S	bib and brace	gray
747102-*	M	bib and brace	gray
747103-*	L	bib and brace	gray
747104-**	XL	bib and brace	gray
747105-***	XXL	bib and brace	gray
747106-****	XXXL	bib and brace	gray



## WINTER SUIT NORFIN ARCTIC 3

Comfortable and warm two-piece suit made especially for fishing, hunting or just recreation in the nature in autumn/winter/spring seasons. The suit is made of NORTEX BREATHABLE material which provides water resistance and complete wind resistance. Ensures warmth and comfort at temperatures as low as -25°C

- Waterproof, windproof material
- Removable knee pads
- Durable material

### JACKET

- ▶ Light, breathable and wind resistant material
- ▶ Two-way open-end zipper with protective flap
- ▶ Taped seams
- ▶ Durable thermal lining
- ▶ Handy inside and outside pockets
- ▶ Flexible inner cuff's
- ▶ Adjustable outer sleeve cuff's
- ▶ Adjustable drawstring and waist
- ▶ Adjustable hood
- ▶ Reflective security prints

### BIB AND BRACE

- ▶ Length-adjustable suspenders
- ▶ Spacious pockets with flaps
- ▶ Reinforced knee and seat area
- ▶ High, adjustable waist
- ▶ Reflective security patches
- ▶ Internal snow gaiters
- ▶ Two-way close – end zipper with protective flap



WATERPROOFING  
**8000 MM**

MATERIAL  
**NORTEX BREATHABLE**

BREATHABILITY  
**6000 G/M<sup>2</sup>/24 HOUR**

INSULATION  
**THERMO GUARD**

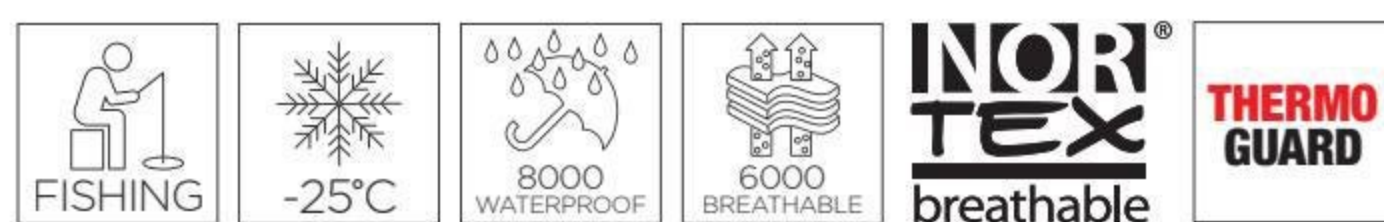

ITEM NO.	SIZE (****)	DESCRIPTION	COLOR
423001-****	S	jacket and bib and brace	gray
423002-****	M	jacket and bib and brace	gray
423003-****	L	jacket and bib and brace	gray
423004-****	XL	jacket and bib and brace	gray
423005-****	XXL	jacket and bib and brace	gray



WINTER SUIT  
**NORFIN ELEMENT+**

Extra warm two-piece suit made especially for fishing, hunting or just recreation in the nature. The suit is made of NORTEX BREATHABLE material which provides water resistance and complete wind resistance.

Designed to keep you warm at temperatures as low as -35°C.

- Extra warm
- Hand warming pockets
- Ergonomic design

**JACKET**

- ▶ Adjustable hood with visor
- ▶ High collar
- ▶ Two-way open-end zipper with protective flap
- ▶ Drawstring to tighten the jacket's waist
- ▶ Hand warming pockets
- ▶ Comfortable pockets outside
- ▶ Adjustable outer sleeve cuff's
- ▶ Reflective security patches
- ▶ Taped seams

**BIB AND BRACE**

- ▶ Length-adjustable suspenders
- ▶ Two-way open-end zipper with protective flap
- ▶ Comfortable, spacious pockets
- ▶ Zip-fasteners on trouser leg
- ▶ Belt loops



WATERPROOFING  
**6000 MM**

MATERIAL  
**NORTEX BREATHABLE**

BREATHABILITY  
**4000 G/M<sup>2</sup>/24 HOUR**

INSULATION  
**THERMO GUARD**

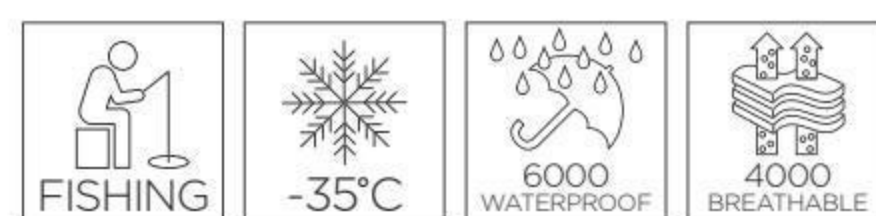

ITEM NO.	SIZE (****)	DESCRIPTION	COLOR
4320-02-M	M	jacket and bib and brace	black
4320-03-L	L	jacket and bib and brace	black
4320-04-XL	XL	jacket and bib and brace	black
4320-05-XXL	XXL	jacket and bib and brace	black



## WINTER SUIT NORFIN ELEMENT GR

This comfortable winter suit is made of very durable materials and features a THERMAL GUARD insulation, that provides you with warmth at temperatures up to -20°C. Laconic and sportive cut will freely allow all movements you need in active fishing.

### JACKET

- ▶ Adjustable, removable hood with visor
- ▶ High collar with fleece lining
- ▶ Two-way open-end zipper with protective flap
- ▶ Drawstring to tighten the jacket's waist
- ▶ Hand warming pockets with waterproof zippers
- ▶ Comfortable pockets outside
- ▶ Warm inside pocket
- ▶ Elastic inner cuff's
- ▶ Adjustable outer sleeve cuff's
- ▶ Taped seams

### BIB AND BRACE

- ▶ Length-adjustable suspenders
- ▶ Two-way open-end zipper with protective flap
- ▶ Comfortable, spacious pockets
- ▶ Zip-fasteners on trouser leg
- ▶ Two outerpockets



WATERPROOFING  
**6000 MM**

MATERIAL  
**NORTEX BREATHABLE**

BREATHABILITY  
**4000 G/M<sup>2</sup>/24 HOUR**

INSULATION  
**THERMO GUARD**

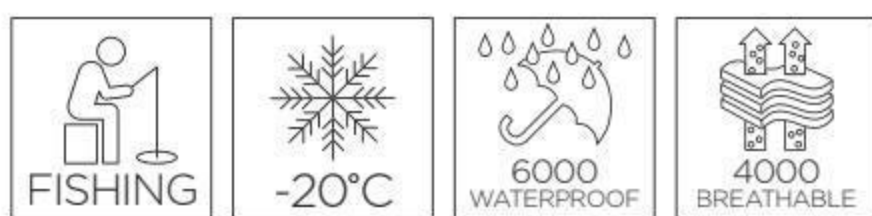

**NORTEX**  
breathable

**THERMO GUARD**

ITEM NO.	SIZE (****)	DESCRIPTION	COLOR
439201-****	S	jacket and bib and brace	gray/green
439202-****	M	jacket and bib and brace	gray/green
439203-****	L	jacket and bib and brace	gray/green
439204-****	XL	jacket and bib and brace	gray/green
439205-****	XXL	jacket and bib and brace	gray/green
439206-****	XXXL	jacket and bib and brace	gray/green



**NEW**

## WINTER SUIT NORFIN ELEMENT FLT

The insulation of the suit has floating properties and does not affect movement. Protects angler if falling in the water. The material of the suit is wind and waterproof membrane fabric. The suit is designed for use in temperatures down to -20°C.

### JACKET

- Adjustable hood with visor
- Hood fastened with zipper
- High collar with fleece lining
- Two-way open-end zipper with protective flap
- Drawstring to tighten the jacket's waist
- Hand warming pockets with waterproof zippers
- Comfortable inner and outer pockets
- Elastic inner sleeve cuff's
- Adjustable outer sleeve cuff's
- Taped seams

### BIB AND BRACE

- Length-adjustable suspenders with locks
- Two-way open-end zipper with protective flap
- Zip-fasteners with protective flap on trouser leg
- Two outer pockets



WATERPROOFING  
**6000 MM**

MATERIAL  
**NORTEX BREATHABLE**

BREATHABILITY  
**4000 G/M<sup>2</sup>/24 HOURS**

INSULATION  
**FLT GUARD**



ITEM NO.	SIZE (****)	DESCRIPTION	COLOR
439501-****	S	jacket, bib and braces	Gray
439502-****	M	jacket, bib and braces	Gray
439503-****	L	jacket, bib and braces	Gray
439504-****	XL	jacket, bib and braces	Gray
439505-****	XXL	jacket, bib and braces	Gray
439506-****	XXXL	jacket, bib and braces	Gray

**TABLE FOR DETERMINING THE SIZE OF NORFIN GARMENTS FOR MEN**

International size:	XS	S	M	M-L	L	L-L	XL	XL-L	XXL	3XL	4XL
European Size:	40-42	44-46	48-50	48/L-50/L	52-54	52/L-54/L	56-58	56/L-58/L	60-62	64-66	68-70
Height:	170-172	171-173	172-174	179-181	173-175	181-183	174-176	183-185	175-177	176-178	177-179
A	80-84	88-92	96-100	96-100	104-108	104-108	112-116	112-116	120-124	128-132	136-140
B	68-72	76-80	84-88	84-88	92-97	92-97	102-108	102-108	114-120	126-132	138-144
C	88-91	94-98	102-106	102-106	110-114	110-114	118-122	118-122	126-130	134-138	142-146
D	80	80	82	85	82	87	84	89	84	84	84
E	73-74	75-77	78,5-80	81,5-83	81,5-83	84-85	84-85	86-87	86-87	87,5-88,5	89-90

**TABLE FOR DETERMINING THE SIZE OF NORFIN GARMENTS FOR WOMEN**

International size:	XS	S	M	L	XL	XXL	3XL	4XL
European Size:	30-32	34-36	38-40	42-44	46-48	50-52	54-56	58-60
Height:	160-162	162-164	164-166	166-168	168-170	170-172	172-174	174-176
A	72-76	80-84	88-92	96-100	104-110	116-122	128-134	140-146
B	60-63	66-69	72-76	80-84	88-93	99-105	111-117	123-129
C	84-87	90-93	96-99	102-106	110-115	120-125	130-135	140-145
D	74	74	76	76	78	78	80	80
E	72	73	74	75	76	77	78	79

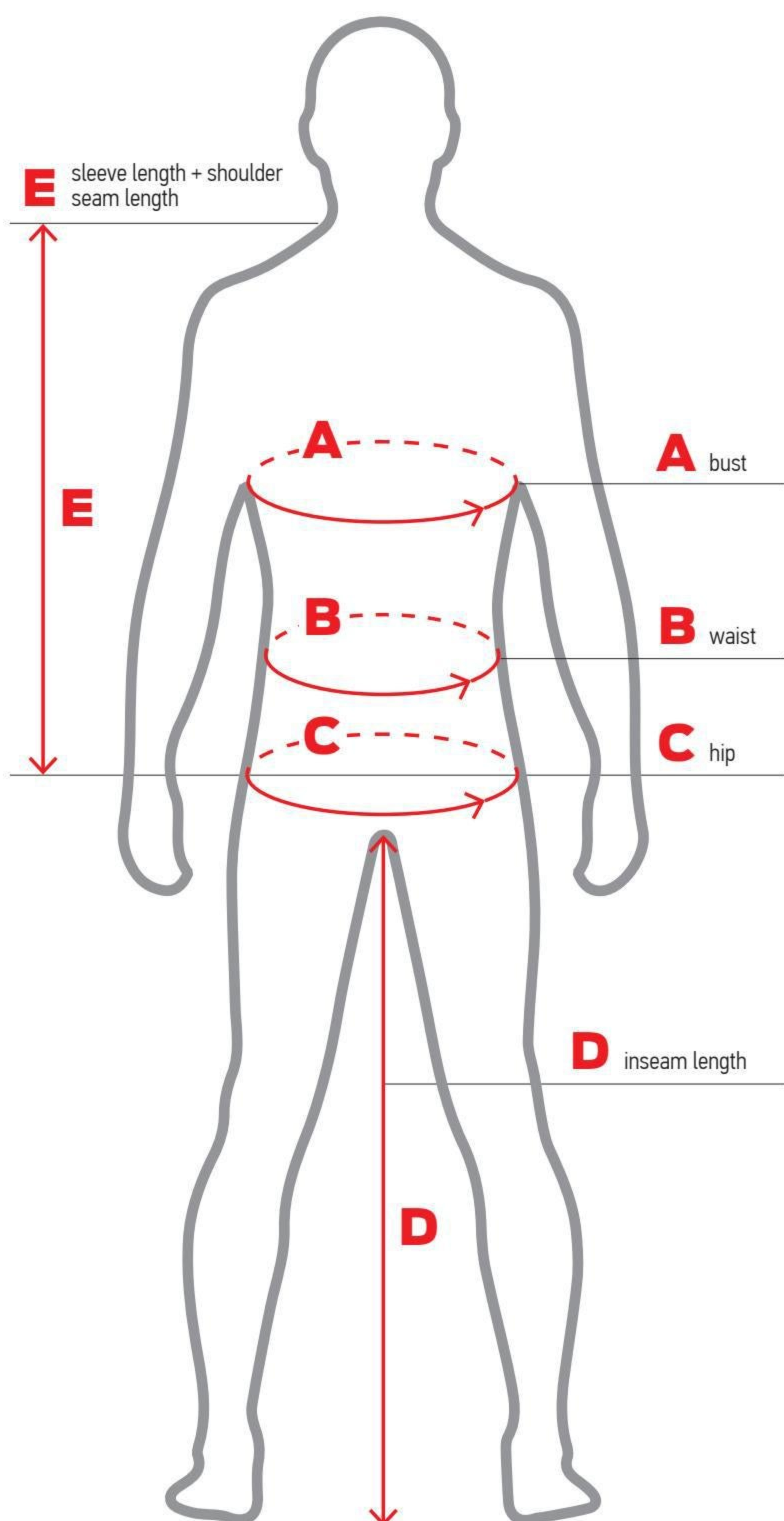

**TABLE FOR DETERMINING THE SIZE OF NORFIN GARMENTS FOR KIDS**

Age:	10-11	11-12	12-13	13-14	14-15
Height:	146	152	158	164	170
A	75	78	81	84	87
B	67	70	72	75	77
C	79	82	85	88	91
D	68	71	74	77	80
E	53	55	57	59	61

**TABLE FOR DETERMINING THE SIZE OF NORFIN HEADWEAR**

International size:	L	XL
Head circumference	58-59	60-61
Headwear size	58-59	60-61

**TABLE FOR DETERMINING THE SIZE OF GLOVES AND MITTS**

International size:	L	XL
Palm circumference (inch)	9	10
Palm circumference (cm)	23	25

**WATERPROOFNESS OF NORFIN WEAR**

Nº	Characteristics of precipitation	Index (mm).
1	Light rain, duration 10-20 minutes	1000-2000
2	Light rain, duration up to 2-3 hours	2000-4000
3	Rain, duration up to 4 hours or drizzling all day	4000-8000
4	Long rain	Over 8000

**COMPLIANCE OF PHYSICAL LOAD WITH INDICES OF "BREATHABILITY" OF NORFIN WEAR**

Nº	Physical load during fishing	Index (g/sq.m/24h)
1	Static angling of fish from the ice on one spot without active search of fish	2000-4000
2	Angling of fish from the ice in combination with active search and ice-hole drilling	4000-8000
3	Walking movement from the ice with snow, active ice-hole drilling, participation in competitions	Over 8000





**NEW**

## JACKET NORFIN THERMO PRO

Designed to be worn either on its own or as an additional layer underneath waterproof jacket. Thermo Pro jacket will regulate your body temperature with the soft 'down-like' synthetic filling. The sleeves are made of a water-resistant heavy weight Nylon spandex material for more comfortable arm movement.

### JACKET:

- Soft comfortable hood with elastic cord adjustment at the back
- Thumb hole at the cuff
- Elastic binding at cuffs and hem for a secure fit
- Stretch chest pocket
- Inner chest pocket
- Side pockets with zippers
- Soft zipper cover at top of the neck

ITEM NO.	SIZE (****)	DESCRIPTION	COLOR
492001-****	S	jacket with a hood	black
492002-****	M	jacket with a hood	black
492003-****	L	jacket with a hood	black
492004-****	XL	jacket with a hood	black
492005-****	XXL	jacket with a hood	black



### MATERIALS

#### MAIN BODY:

**100% 380T NYLON TAFFETA**

#### CUFFS/SLEEVES/POCKET:

**94% NYLON 6% SPANDEX**

#### PADDING:

**100% SYNTHETIC DOWN LIKE POLYESTER**



**NEW**

## FLEECE JACKET NORFIN VECTOR

Windproof, breathable Vector jacket with dynamic design. Mobile, light-weight jacket features a comfortable, adjustable hood to ensure maximum protection from strong wind and light precipitation. Perfectly suitable for a variety of outdoor activities as well as for everyday use.

- Front zipper
- High collar
- Adjustable hood
- Drawstring to tighten the jacket lower part
- Two side pockets and one chest pocket with zipper
- Adjustable outer sleeve cuffs

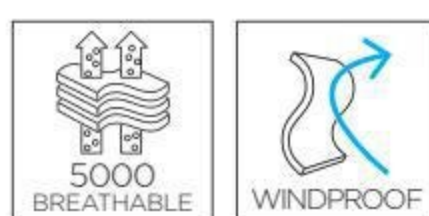

ITEM NO.	SIZE (****)	DESCRIPTION	COLOR
418002-****	M	jacket with a hood	gray, black
418003-****	L	jacket with a hood	gray, black
418004-****	XL	jacket with a hood	gray, black
418005-****	XXL	jacket with a hood	gray, black
418006-****	XXXL	jacket with a hood	gray, black



### MATERIAL

**70% POLYESTER, 30% PU MEMBRANE**  
**BREATHABILITY: 5000 G/M<sup>2</sup>/24 HOURS**

LUCKY JOHN  
SUMMER

FEEDER  
CONCEPT

NORFIN  
SUMMER

LUCKY JOHN  
WINTER

NORFIN  
WINTER

MARKETING  
MATERIALS



## FLEECE JACKET NORFIN FROST

Simple cut jacket is developed for a variety of outdoor activities, it can be worn on its own, as a outer layer, at moderate temperatures, or as a warm mid – layer, when the temperatures are way below 0°C. Synthetic material offers superior performance for high quality lightweight and breathable cold weather gear.

- Full length front zipper
- Chest pocket with zipper
- Two side pockets with zippers
- Drawstring bottom



ITEM NO.	SIZE (****)	DESCRIPTION	COLOR
481001-****	S	jacket	black
481002-****	M	jacket	black
481003-****	L	jacket	black
481004-****	XL	jacket	black
481005-****	XXL	jacket	black



MATERIAL  
**NORFLEECE THERMO+**  
(100% POLYESTER)



## FLEECE JACKET NORFIN CELSIUS

Warm fleece jacket designed for outdoor activity enthusiasts. Fishing or just spending time outdoors our heavyweight sweater-knit fleece hoodie will provide you with thermal insulation in cool-to-cold conditions.

### JACKET

- Full length front zipper
- Standard fit
- Sweater- knit fleece with brushed backer
- Drawstring bottom
- Two side pockets



ITEM NO.	SIZE (****)	DESCRIPTION
479001-****	S	hooded jacket
479002-****	M	hooded jacket
479003-****	L	hooded jacket
479004-****	XL	hooded jacket
479005-****	XXL	hooded jacket
479006-****	XXXL	hooded jacket



MATERIAL  
**NORFLEECE THERMO +**  
(100% POLYESTER)



## FLEECE JACKET NORFIN GLACIER GRAY

Soft and durable fleece material. Full zip front jacket with stand up collar, side hand warmer pockets and bungee drawstring waist to keep out the chilly winds. Ideal costume for chilly evening or fresh morning on the lake or river.

- High collar
- Adjustable waist
- For pockets



ITEM NO.	SIZE (****)	DESCRIPTION
477101-****	S	jacket
477102-****	M	jacket
477103-****	L	jacket
477104-****	XL	jacket
477105-****	XXL	jacket



MATERIAL  
**NORFLEECE THERMO**  
(100% POLYESTER)



## FLEECE JACKET NORFIN ONYX

Lightweight fleece jacket, designed for outdoor activity enthusiasts. The jacket suits perfectly for people who prefer active recreation – tourists and anglers, but it is also suitable for casual wear.

### JACKET

- Full length front zipper
- Drawstring bottom
- Two side pockets
- Chest pocket with zipper



ITEM NO.	SIZE (****)	DESCRIPTION
450001-****	S	jacket
450002-****	M	jacket
450003-****	L	jacket
450004-****	XL	jacket
450005-****	XXL	jacket
450006-****	XXXL	jacket



MATERIAL  
**NORFLEECE THERMO**  
(100% POLYESTER)

# NORFIN

## THERMAL UNDERWEAR

### TEMPERATURE



### ACTIVITY

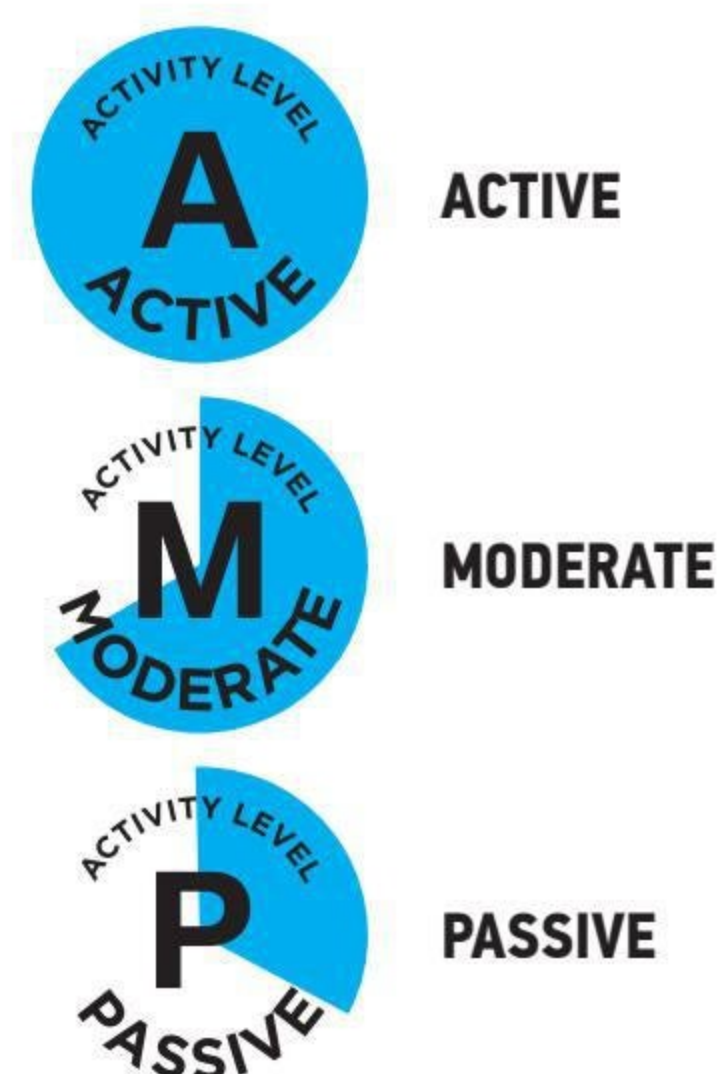

### FEECE SUIT **NORFIN POLAR LINE 2 GRAY**

Soft and durable fleece material. Full zip front jacket with stand up collar, side hand warmer pockets and bungee drawstring waist to keep out the chilly winds. Trousers with zip pockets, flexible waist and leg bottoms. Ideal costume for chilly evening or fresh morning on the lake or river.

#### JACKET

- ▶ High collar
- ▶ Mesh lining
- ▶ Adjustable waist
- ▶ For pockets

#### TROUSERS

- ▶ Elastic waist
- ▶ Two pockets
- ▶ Strengthened material on knee area



**NORFLEECE**  
Thermo +

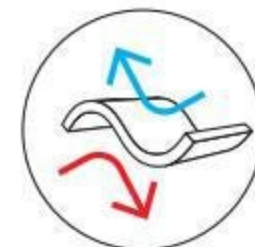

- ▶ retains warmth of the body
- ▶ protects against wind and cold
- ▶ «breathable» material
- ▶ pleasant to the touch

ITEM NO.	SIZE (****)	DESCRIPTION
337101-****	S	jacket and trousers
337102-****	M	jacket and trousers
337103-****	L	jacket and trousers
337104-****	XL	jacket and trousers
337105-****	XXL	jacket and trousers
337106-****	XXXL	jacket and trousers

MATERIAL  
**NORFLEECE THERMO +**  
(100% POLYESTER)



## MICRO FLEECE UNDERWEAR NORFIN NORD

This functional thermal underwear is made of high – quality micro fleece and can be used as a base or second layer. The soft, pleasant fabric leads moisture away from your body and keeps you warm, ensuring comfort and high performance. The specially designed material is very breathable, and ensures enhanced protection from cold temperatures, and flawlessly regulates the core temperature of your body.

- ▶ Soft and pleasant in wear
- ▶ Secure zipper
- ▶ Elastic waist
- ▶ Flexible cuffs on the leg bottom



### MATERIAL NORFLEECE MICRO (100% POLYESTER)

ITEM NO.	SIZE (****)	DESCRIPTION
3027001-****	S	jacket and trousers
3027002-****	M	jacket and trousers
3027003-****	L	jacket and trousers
3027004-****	XL	jacket and trousers
3027005-****	XXL	jacket and trousers
3027006-****	XXXL	jacket and trousers



**NOR FLEECE**  
Micro

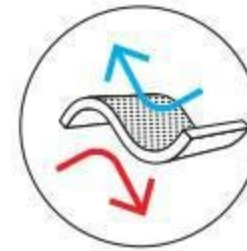

- ▶ high «breathability»
- ▶ pleasant to the touch
- ▶ retains warmth of the body
- ▶ dries quickly



## THERMAL UNDERWEAR NORFIN WINTER LINE/WINTER LINE GRAY

Thermal underwear, made of fleece, is intended for various outdoor activities in cold weather. The fabric provides active moisture removal and preserves warmth during medium physical activity. This warm, lightweight underwear ensures comfort, regardless of the type of activity.

- ▶ High collar
- ▶ Front zipper
- ▶ Elastic cuffs
- ▶ Elastic waistband

### MATERIAL POLYESTER

ITEM NO.	SIZE (****)	DESCRIPTION	ITEM NO.	SIZE (****)	DESCRIPTION
3036001-****	S	jacket and trousers	3025002-****	M	jacket and trousers
3036002-****	M	jacket and trousers	3025003-****	L	jacket and trousers
3036003-****	L	jacket and trousers	3025004-****	XL	jacket and trousers
3036004-****	XL	jacket and trousers	3025005-****	XXL	jacket and trousers
3036005-****	XXL	jacket and trousers	3025006-****	XXXL	jacket and trousers
3036006-****	XXXL	jacket and trousers			





## THERMAL UNDERWEAR NORFIN COSY LINE

Used by fisherman and other extreme and fearless man, it has technically enhanced properties that make it unique and inimitable. It has high breathability and thermal properties. Cosy Line traps warm air next to the skin, and maintains a comfortable warmth whether the you are static or at a high level of activity. It ensures that moist air is transferred to the outside of the garment, where it evaporates. Soft and light fabric doesn't make bulk and ensures comfortable wear.

- ▶ Removable hood
- ▶ Zipper in front
- ▶ Elastic belt
- ▶ Elastic cuffs

MATERIAL  
**POLYESTER**

ITEM NO.	SIZE (****)	DESCRIPTION
3007101-****	S	jacket and trousers
3007102-****	M	jacket and trousers
3007103-****	L	jacket and trousers
3007104-****	XL	jacket and trousers
3007105-****	XXL	jacket and trousers
3007106-****	XXXL	jacket and trousers
3007107-****	XXXXL	jacket and trousers



## THERMAL UNDERWEAR NORFIN THERMO LINE 2

Base layer thermal underwear with ergonomic fit and innovative material that wicks sweat. Ergonomic fit provides superior comfort and freedom of movement. Heat Line thermal underwear will protect from cold in all your favorite type of activities – fishing, hunting and outdoors.

- ▶ Flat seams
- ▶ Elastic waist

MATERIAL  
**100% POLYESTER**

ITEM NO.	SIZE (****)	DESCRIPTION
3008301-****	S	jacket and trousers
3008302-****	M	jacket and trousers
3008303-****	L	jacket and trousers
3008304-****	XL	jacket and trousers
3008305-****	XXL	jacket and trousers
3008306-****	XXXL	jacket and trousers





## THERMAL UNDERWEAR NORFIN COMFORT LINE

specially designed Thermal underwear with micro fleece inlets on the back of trousers and shirt to protect most sensitive part of the body. Light and warm material provides comfort in cold weather.

- ▶ Microfleece lining at waist and back side
- ▶ Elastic cuffs
- ▶ Elastic waist

MATERIAL  
**95% POLYESTER, 5% SPANDEX**

ITEM NO.	SIZE (****)	DESCRIPTION
3019001-****	S	jacket and trousers
3019002-****	M	jacket and trousers
3019003-****	L	jacket and trousers
3019004-****	XL	jacket and trousers
3019005-****	XXL	jacket and trousers
3019006-****	XXXL	jacket and trousers



## HAND WARMER NORFIN BY ONLY HOT

The warmer made for protecting your hand from cold temperatures. Perfect for fishermen and those who are outdoors with frigid temperatures. It puts out an average heat of 53°C and can reach maximum temperature of 67°C.



ITEM NO.	SIZE	OPERATING TIME
N-100HW	5 x 9	10 hours

## TOE WARMER NORFIN BY ONLY HOT

The ideal solution to solve the problem of cold foot fingers. Toe warmers are very thin with a rounded adhesive top perfect for every kind of shoes, both for men and women. It puts out an average heat of 36°C and can reach maximum temperature of 43°C.



ITEM NO.	SIZE	OPERATING TIME
N-100TW	7 x 9,5	6 hours

## FOOT WARMER NORFIN BY ONLY HOT

A really thin self-heating insole for every type of shoes and boots, perfect for keeping your foot warm. It puts out an average heat of 35°C and can reach maximum temperature of 39°C.

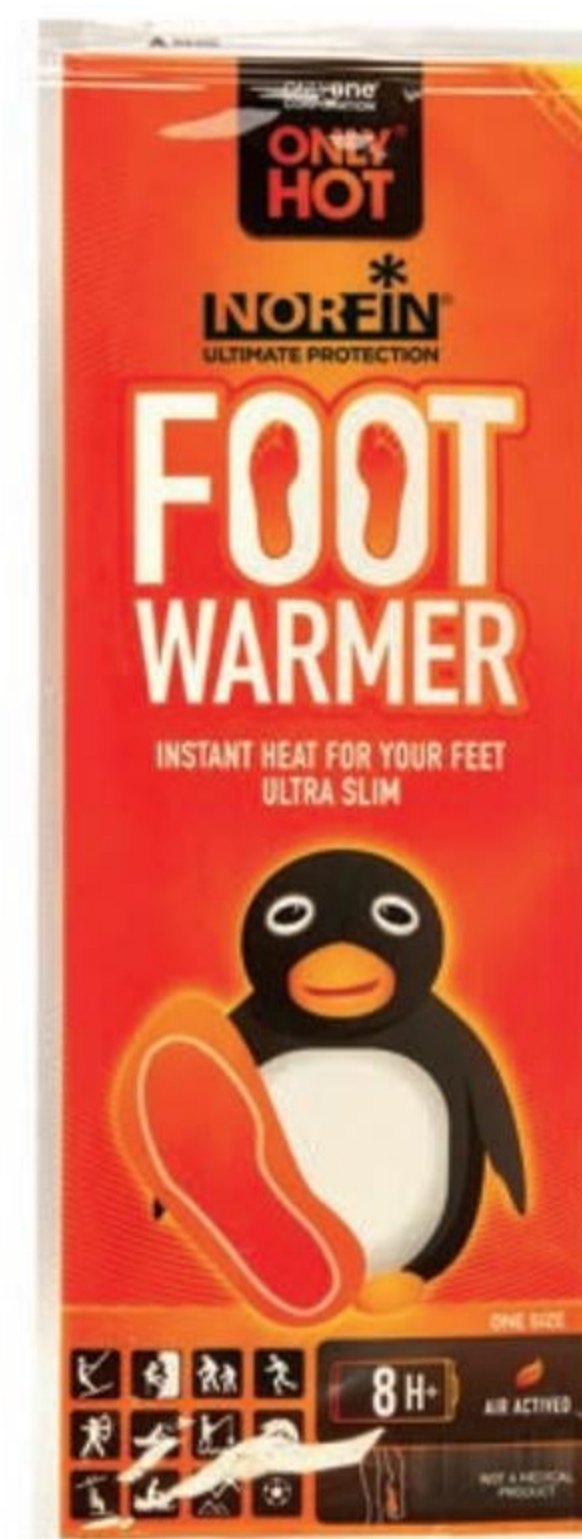

ITEM NO.	SIZE	OPERATING TIME
N-100FW	8,5 x 25	8 hours

## NORFIN WINTER HATS AND MASKS

### WINTER HAT NORFIN ZERO



ITEM NO.	SIZE (****)	DESCRIPTION	MATERIAL	COLOR
302757-**	L, XL	artificial fur	100% polyester	gray/black

### WINTER HAT NORFIN CRYSTAL



ITEM NO.	SIZE (****)	DESCRIPTION	MATERIAL	COLOR
302743**	L, XL	Beanie	100% Acrylic	green/orange

### WINTER HAT NORFIN TORNADO



ITEM NO.	SIZE (****)	DESCRIPTION	MATERIAL	COLOR
302753-**	XL	Fleece lining	100% Acrylic	gray/blue/red

### WINTER HAT NORFIN NORWAY MAN



ITEM NO.	SIZE (****)	DESCRIPTION	MATERIAL	COLOR
303347**	L, XL	With Fleece insulation	100% Acrylic, 100% Polyester insulation	gray/blue/white

### HAT NORFIN COBOLD REFLECTIVE **NEW**



ITEM NO.	SIZE (****)	DESCRIPTION	MATERIAL	COLOR
302748-**	L, XL	Reflective, lining: fleece	100% acrylic, Fleece	black

### HAT NORFIN FIN WINDSTOP **NEW**



ITEM NO.	SIZE (****)	DESCRIPTION	MATERIAL	COLOR
302749-**	L, XL	windproof	80% polyester 20% PU	black



## WINTER HAT NORFIN LOCKER



ITEM NO.	SIZE (****)	DESCRIPTION	MATERIAL	COLOR
302758-**	L, XL	Fleece lining	100% Acrylic; lining: 95% polyester, 5% elastane	black

## WINTER HAT NORFIN KOBOLD WARM GY



ITEM NO.	SIZE (****)	DESCRIPTION	MATERIAL	COLOR
302742-**	L, XL	With Fleece and Thinsulate insulation	45% Polyester, 55% Cotton	gray

## WINTER HAT NORFIN FLEECE



302783-BL

302783-GY

ITEM NO.	SIZE (****)	DESCRIPTION	MATERIAL	COLOR
302783-BL-**	L, XL	padding: polyester	100% polyester	black
302783-GY-**	L, XL	padding: polyester	100% polyester	gray

## WINTER HAT NORFIN CLASSIC



ITEM NO.	SIZE (****)	DESCRIPTION	MATERIAL	COLOR
302920-**	XL	knitted	100% acryl	green

## MASK NORFIN KNITTED



ITEM NO.	SIZE (****)	DESCRIPTION	MATERIAL	COLOR
303339-**	L, XL	Knitted mask	100% Acrylic	black

## MASK NORFIN BETA



ITEM NO.	SIZE (****)	DESCRIPTION	MATERIAL	COLOR
303337-**	L, XL	Windstop front peac	90% Polyester 10% Elastane	black

## MASK NORFIN MASK



ITEM NO.	SIZE (****)	DESCRIPTION	MATERIAL	COLOR
303338-**	L, XL	Universal mask	100% Polyester	gray

## GLOVES NORFIN GALE WINDSTOP

**NEW**



ITEM NO.	SIZE (****)	DESCRIPTION	MATERIAL
703024-**	L, XL	windproof reflective security elements	80% polyester, 20% PU

## GLOVES-MITTENS NORFIN AURORA BLACK

**NEW**



ITEM NO.	SIZE (****)	DESCRIPTION	MATERIAL	COLOR
703035-**	L, XL	windproof gloves-mittens, detachable reinforced palm area	100% polyester	gray/black

## GLOVES NORFIN POINT

Windproof gloves, made from high quality polyester material.



ITEM NO.	SIZE	DESCRIPTION	MATERIAL	COLOR
703063-**	L; XL; XXL	windstop fleece	Polyester	gray

## GLOVES NORFIN ARGO

Windproof gloves, made from high quality polyester material.



ITEM NO.	SIZE	DESCRIPTION	MATERIAL	COLOR
703066-**	L; XL; XXL	windstop fleece	Polyester	gray

## GLOVES NORFIN HELIUM

Windproof gloves, made from high quality polyester material.



ITEM NO.	SIZE	DESCRIPTION	MATERIAL	COLOR
703067-**	L; XL; XXL	windstop fleece	Polyester	gray

## GLOVES NORFIN SOFT SHELL



ITEM NO.	SIZE (****)	DESCRIPTION	MATERIAL	COLOR
703061**	L, XL	Windproof softshell material	95% Polyester, 5% Elastan, 100% Polyester lining	black

## GLOVES NORFIN BASIC



ITEM NO.	SIZE (****)	DESCRIPTION	MATERIAL	COLOR
703022-**	L, XL	fleece	100% polyester	black

## GLOVES NORFIN VECTOR



ITEM NO.	SIZE (****)	DESCRIPTION	MATERIAL	COLOR
703023-**	L, XL	Thinsulate insulation	100% Polyester	black

## GLOVES NORFIN SHIFTER



ITEM NO.	SIZE (****)	DESCRIPTION	MATERIAL	COLOR
703077**	03L, 04XL	Thinsulate insulation	100% Polyester	gray

## GLOVES NORFIN WISDOM



ITEM NO.	SIZE (****)	DESCRIPTION	MATERIAL	COLOR
703033-**	L, XL	Thinsulate insulation	50% Acrylic; 50% wool	white/brown

## GLOVES-MITTENS AURORA



ITEM NO.	SIZE (****)	DESCRIPTION	MATERIAL	COLOR
703025-**	L, XL	wind-resistant gloves-mittens, detachable	polyester	gray/brown

## GLOVES-MITTENS MAGNET



ITEM NO.	SIZE (****)	DESCRIPTION	MATERIAL	COLOR
303108-**	L, XL	wind-resistant gloves-mittens, fixation with magnet	polyester	gray/brown

# SOCKS NORFIN

## TEMPERATURE

**T1** COOL

**T2** COLD

**T3** VERY COLD

**T4** EXTREME COLD

## ACTIVITY

**A** HIGH ACTIVE

**M** MEDIUM MODERATE

**P** LOW PASSIVE

## ACTIVITY

**LONG**

**SHORT**

### SOCKS NORFIN MERINO MIDWEIGHT T4A



The T4A Merino Midweight socks were designed for moderate activity use in rugged conditions where moisture and warmth are an issue. Made with Merino Wool that provides warmth without overheating the foot.

- ▶ Perfect fit for comfort
- ▶ Multiple density
- ▶ Resistance and durability

SHORT

MERINO WOOL 100% NATURAL

T4 EXTREME COLD

A HIGH ACTIVE

ITEM NO.	SIZE	MATERIAL
303804-**	02M (39-41)	80% Merino wool, 15% Nylon, 5% Spandex
303804-**	03L (42-44)	80% Merino wool, 15% Nylon, 5% Spandex
303804-**	04XL (45-47)	80% Merino wool, 15% Nylon, 5% Spandex

### SOCKS NORFIN ARCTIC MERINO HEAVY T4M



The T4M Merino Heavy socks were designed for moderate activity use in rugged conditions where moisture and warmth are an issue. Merino Wool provides warmth while wicking moisture away from the foot. Knit with heavy cushioning all throughout the sock for warmth and a perfect fit within your boots that prevents irritation from the inner boot liner.

- ▶ Perfect fit for comfort
- ▶ Multiple density
- ▶ Resistance and durability

LONG

MERINO WOOL 100% NATURAL

T4 EXTREME COLD

M MEDIUM MODERATE

ITEM NO.	SIZE	MATERIAL
303805-**	02M (39-41)	70% Merino wool, 25% Nylon, 5% Elastane
303805-**	03L (42-44)	70% Merino wool, 25% Nylon, 5% Elastane
303805-**	04XL (45-47)	70% Merino wool, 25% Nylon, 5% Elastane

## SOCKS NORFIN NORDIC MERINO LIGHT T3A



The T3A Nordic Merino Light socks has unique construction with light cushioning for protection and warmth. Merino Wool provides all-day warmth while wicking moisture away from the foot to keep you dry. The combination of Merino Wool and Acrylic provides all-day warmth while wicking moisture away from the foot to keep you dry

- ▶ Perfect fit for comfort
- ▶ Flat seams
- ▶ Resistance and durability



ITEM NO.	SIZE	MATERIAL
303902-**-	02M (39-41)	35% Merino wool, 35% Acrylic, 22% Nylon, 8% Elastane
303902-**-	03L (42-44)	35% Merino wool, 35% Acrylic, 22% Nylon, 8% Elastane
303902-**-	04XL (45-47)	35% Merino wool, 35% Acrylic, 22% Nylon, 8% Elastane

## SOCKS NORFIN NORDIC MERINO MIDWEIGHT T3M



The T3M Nordic Merino Midweight socks has unique construction with light cushioning for protection and warmth. Merino Wool provides all-day warmth while wicking moisture away from the foot to keep you dry. Medium cushioning provides impact protection and ultimate comfort.

- ▶ Perfect fit for comfort
- ▶ Flat seams
- ▶ Resistance and durability



ITEM NO.	SIZE	MATERIAL
303901-**-	02M (39-41)	25% Merino wool, 55% Acrylic, 5% Polyamide, 15% Elastane
303901-**-	03L (42-44)	25% Merino wool, 55% Acrylic, 5% Polyamide, 15% Elastane
303901-**-	04XL (45-47)	25% Merino wool, 55% Acrylic, 5% Polyamide, 15% Elastane

## SOCKS NORFIN NORDIC MERINO HEAVY T3P



The T3P Nordic Merino Heavy socks were designed for love activity use in rugged conditions where moisture and warmth are an issue. Made with Merino Wool that provides warmth without overheating the foot and ultra-fine acrylic fibers, resulting in a soft feel while providing unparalleled moisture wicking.

- ▶ Perfect fit for comfort
- ▶ Soft Material
- ▶ Resistance and durability



ITEM NO.	SIZE	MATERIAL
303903-**-	02M (39-41)	80% Merino wool, 15% Nylon, 5% Spandex
303903-**-	03L (42-44)	80% Merino wool, 15% Nylon, 5% Spandex
303903-**-	04XL (45-47)	80% Merino wool, 15% Nylon, 5% Spandex



## SOCKS NORFIN BALANCE LONG T2A



The T2A Balance Long socks were designed for active use in rugged conditions where moisture and warmth are an issue. Made with Coolmax these socks provide maximum moisture management in active use.



ITEM NO.	SIZE	MATERIAL
303741-**-	02M (39-41)	35% Cotton, 35% Coolmax, 25% Nylon, 5% Elastan
303741-**-	03L (42-44)	35% Cotton, 35% Coolmax, 25% Nylon, 5% Elastan
303741-**-	04XL (45-47)	35% Cotton, 35% Coolmax, 25% Nylon, 5% Elastan

## SOCKS NORFIN BALANCE MIDDLE T2M



T2M, suitable for fishing, hunting and any other outdoor activity of your choice, when the temperatures are moderate and cold. To ensure additional comfort, the socks are fully cushioned and have an elasticized arch, that adds support to your ankle and heel. The special body hugging close fit does not let the socks slip.



ITEM NO.	SIZE	MATERIAL
303742-**-	02M (39-41)	80% Acrylic, 15% Polyester, 5% Elastan
303742-**-	03L (42-44)	80% Acrylic, 15% Polyester, 5% Elastan
303742-**-	04XL (45-47)	80% Acrylic, 15% Polyester, 5% Elastan

## SOCKS NORFIN BALANCE WOOL T2P



T2P, suitable for fishing, hunting and any other outdoor activity of your choice, when the temperatures are cold. Multiple density technology ensures comfortable fit and moisture management.



ITEM NO.	SIZE	MATERIAL
303743-**-	02M (39-41)	70% Acrylic, 20% Polyester, 5% Elastan
303743-**-	03L (42-44)	70% Acrylic, 20% Polyester, 5% Elastan
303743-**-	04XL (45-47)	70% Acrylic, 20% Polyester, 5% Elastan

## SOCKS NORFIN BALANCE JUNIOR T2M

**JUNIOR**



ITEM NO.	SIZE	MATERIAL
303745-**-	02M (32-34) (20-22 cm)	80% Acrylic, 15% Polyester, 5% Elastan
303745-**-	03L (35-38) (22-24 cm)	80% Acrylic, 15% Polyester, 5% Elastan

## SOCKS NORFIN TARGET LIGHT T1A



T1A socks are designed to be worn in all kind of activities in cool weather. Sorbtex yarn gives this sock excellent moisture management ability as well as tight fit.



ITEM NO.	SIZE	MATERIAL
303751-**-	02M (39-41)	80% Sorbtex, 15% Nylon, 5% Elastan
303751-**-	03L (42-44)	80% Sorbtex, 15% Nylon, 5% Elastan
303751-**-	04XL (45-47)	80% Sorbtex, 15% Nylon, 5% Elastan

## SOCKS NORFIN TARGET BASIC T1M



T1M middle length basic thermal socks for different outdoor activities. Synthetic material insures good moisture management. Exceptionally soft and cushioned material.



ITEM NO.	SIZE	MATERIAL
303752-**-	02M (39-41)	100% Acrylic
303752-**-	03L (42-44)	100% Acrylic
303752-**-	04XL (45-47)	100% Acrylic

## SOCKS NORFIN TARGET HEAVY T1P

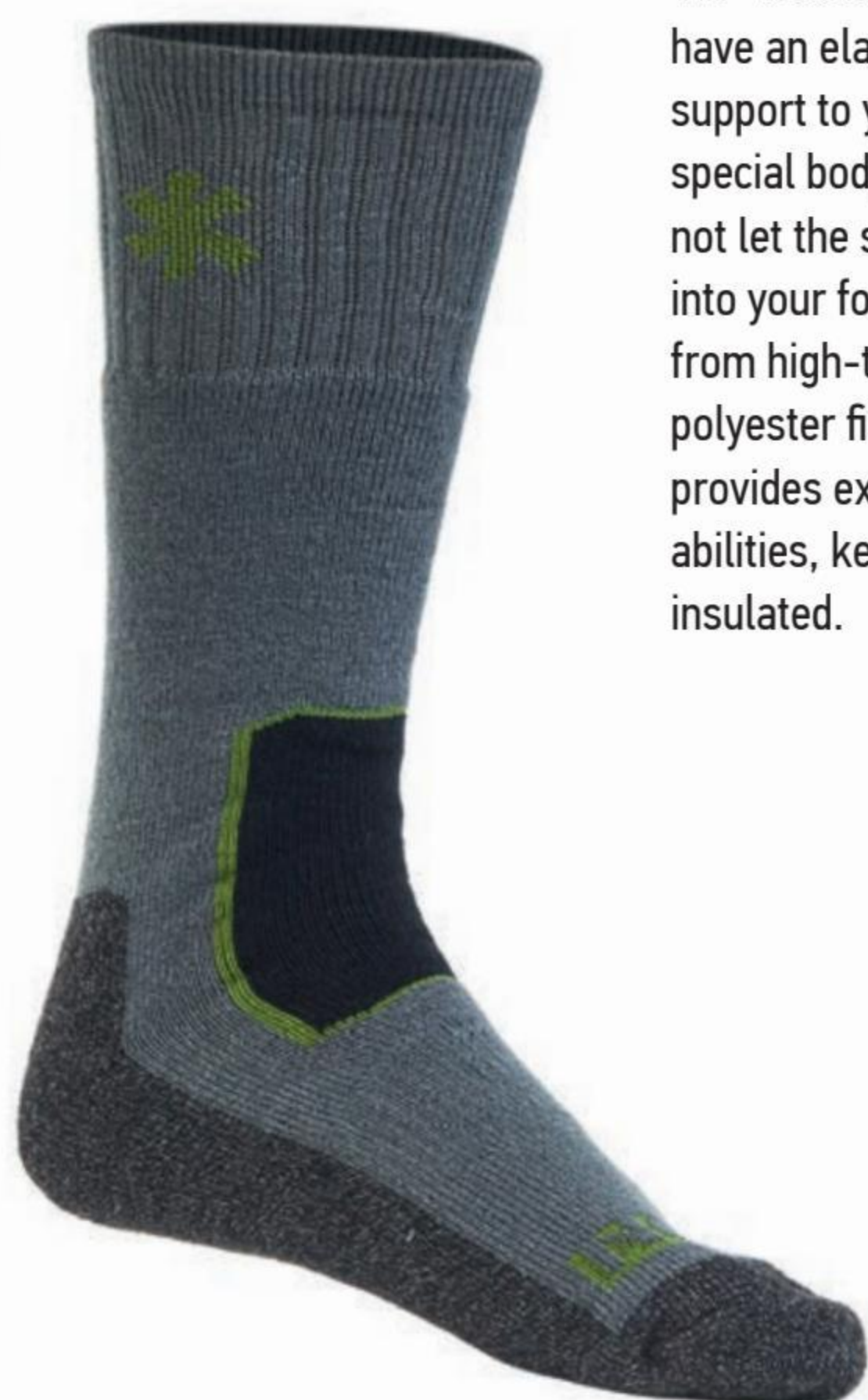

T1P socks are fully cushioned and have an elasticized arch, that adds support to your ankle and heal. The special body hugging close fit does not let the socks slip downwards into your footwear. Constructed from high-tech acrylic and polyester fibers, the used materials provides excellent moisture control abilities, keeping your feet well insulated.



ITEM NO.	SIZE	MATERIAL
303753-**-	02M (39-41)	18% Polyester, 75% Acrylic, 5% Nylon, 2% Elastan
303753-**-	03L (42-44)	18% Polyester, 75% Acrylic, 5% Nylon, 2% Elastan
303753-**-	04XL (45-47)	18% Polyester, 75% Acrylic, 5% Nylon, 2% Elastan





**NEW**

## WINTER BOOTS NORFIN KLONDAIK 2

Winter boots made of EVA material with removable insole. Thanks to the thick and warm insole and EVA (foam rubber) material, boots can be comfortably used at temperatures as low as -40°C.

ANTI-SLIP DUO system – two retractable ice cleats for added safety and protection. Cleats are made of durable stainless steel which prolongs their use in various weather conditions.

Triple 10 mm thick insole provides thermal insulation:

- Inner Thinsulate™ layer provides thermal insulation and absorbs and wicks away moisture.
- Heat reflecting aluminum foil keeps cold away and keeps body heat to the foot
- External layer of polyester provides required insulation and wicks moisture from the insole.

**Material:** EVA, Rubber  
**Insulation:** THINSULATE



ITEM NO.	SIZE (****)	DESCRIPTION
16990-40	40	EVA, Rubber
16990-41	41	EVA, Rubber
16990-42	42	EVA, Rubber
16990-43	43	EVA, Rubber
16990-44	44	EVA, Rubber
16990-45	45	EVA, Rubber
16990-46	46	EVA, Rubber
16990-47	47	EVA, Rubber



**EXTRA LIGHT**



## WINTER BOOTS NORFIN KLONDAIK

Winter boots made of EVA material with removable insole. Thanks to the thick and warm insole and EVA (foam rubber) material, boots can be comfortably used at temperatures as low as -40°C. Rubber sole protects it from cutting or pricking. There are special removable spikes in heels to avoid slipping on ice. Triple 10mm thick insole provides thermal insulation:

- ▶ Inner Thinsulate™ layer provides thermal insulation and absorbs and wicks away moisture
- ▶ Heat reflecting aluminum foil keeps cold out and keeps body heat to the foot
- ▶ External layer of polyester provides required insulation and wicks moisture away from the insole.

**Material:** EVA  
**Insulation:** THINSULATE



ITEM NO.	SIZE	WEIGHT (KG)
14990-40	40	2,37
14990-41	41	2,47
14990-42	42	2,50
14990-43	43	2,58
14990-44	44	2,64
14990-45	45	2,73
14990-46	46	2,87
14990-47	47	3,04





# NOREIN® Element

## WINTER BOOTS NORFIN ELEMENT

Winter boots made of EVA material with removable insole ensure continuous thermal protection at temperatures as low as -30°C. Rich in micro bubbles (foam rubber), the material has perfect thermal insulation ability and is lightweight. The boots weigh 30-40% less than their rubber or PVC counterparts.

- ▶ Boot made out of super light and durable EVA material
- ▶ Thick outsole to provide best thermal insulation
- ▶ Removable inlet from Polyester material



EXTRA  
LIGHT

ITEM NO.	SIZE	DESCRIPTION	WEIGHT (KG)
14830-**	41-48	EVA material	0,84-1,06

# NOREIN® Snow

## WINTER BOOTS NORFIN SNOW

Light and comfortable winter boots, ideal for long walk on snow and ice as well as in town. Upper is made out of durable 900D oxford nylon. Comfortable use up to -20 0C.

- ▶ Perfect synthetic inner layer ensures comfort in any conditions
- ▶ Upper made of durable nylon
- ▶ Sole made of high quality EVE material
- ▶ Best flexibility in low temperature
- ▶ Specially designed sole for better non skid traction

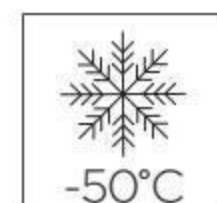

ITEM NO.	SIZE (****)	DESCRIPTION	COLOR	WEIGHT (KG)
13980-**	40; 41; 42; 43; 44; 45; 46	with laces	green	1,54-1,99

# NOREIN® Avalanche

## WINTER BOOTS NORFIN AVALANCHE

Warm and comfortable, lightweight winter boots made of EVA material with rubber sole, feature a high quality synthetic material insulation. You can use these functional boots in temperatures up to -40C  
Three layer, 10mm thick liner ensures reliable thermal insulation:

- ▶ 200g Synthetic felt layer ensures thermal insulation and absorbs moisture
- ▶ Foil reflects cold air and keeps the warm air inside
- ▶ Fleece holds the warm air and ensures thermal insulation
- ▶ Abrasion resistant nylon upper
- ▶ Adjustable snow collar

Materials:  
Outsole: **EVA, Rubber,**  
Upper: **1200 D Nylon**  
Insulation: **Polyester, foil**

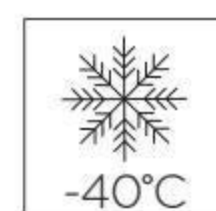

ITEM NO.	SIZE (****)	DESCRIPTION
14910-40	40	nylon, EVA+rubber
14910-41	41	nylon, EVA+rubber
14910-42	42	nylon, EVA+rubber
14910-43	43	nylon, EVA+rubber
14910-44	44	nylon, EVA+rubber
14910-45	45	nylon, EVA+rubber
14910-46	46	nylon, EVA+rubber



## WINTER JACKET NORFIN WOMEN NORDIC PURPLE/SPACE BLUE

Jacket Nordic is especially designed for women-anglers and outdoor enthusiasts. Elastic but durable outer material will provide maximum flexibility needed for variety outdoor activities. Extra warm insulation will keep you warm at temperatures as low as -30°C.

### JACKETS

- Taped seams
- Special lining design with areas that improve moisture wicking
- Two-way open-end zipper with protective flap
- High collar with fleece lining
- Drawstring to tighten the jacket's lower part
- Snow skirt
- Handy inside and outside pockets
- Zippered hand warming pockets
- Inner pocket for gloves
- Elastic nylon inner cuffs
- Adjustable outer sleeve cuffs
- Reflective security prints



542100-\*\*\*\*



542000-\*\*\*\*

## WINTER BIB AND BRACE NORFIN WOMEN NORDIC SPACE BLUE

Winter bibs Nordic especially designed for women-anglers and outdoor enthusiasts. Elastic but durable outer material will provide maximum flexibility needed for all outdoor activities. Extra warm insulation will keep you warm at temperatures as low as -30°C. Elastic, durable material. Extra warm insulation. Soft and warm nylon lining

### BIB

- Length-adjustable suspenders
- Zipper with protective flap
- Higher back
- Adjustable waist
- Handy side pockets with zippers
- Chest pocket with zipper
- Zip-fasteners on trouser legs
- Inner snow gaiters



552000-\*



<b>WATERPROOFING</b> <b>8000 MM</b>	<b>MATERIAL</b> <b>NORTEX</b> <b>BREATHABLE</b>	<b>BREATHABILITY</b> <b>6000 G/M<sup>2</sup>/24</b> <b>HOURS</b>	<b>INSULATION</b> <b>HOLLOFIL</b>
----------------------------------------	-------------------------------------------------------	------------------------------------------------------------------------	--------------------------------------

ITEM NO.	SIZE (****)	DESCRIPTION	COLOR
542***-*	S	jacket	purple or space-blue
542***-*	M	jacket	purple or space-blue
542***-*	L	jacket	purple or space-blue
542***-*	XL	jacket	purple or space-blue
542***-*	XXL	jacket	purple or space-blue

ITEM NO.	SIZE (****)	DESCRIPTION	COLOR
552000-****	XS	bib and brace	space-blue
552001-****	S	bib and brace	space-blue
552002-****	M	bib and brace	space-blue
552003-****	L	bib and brace	space-blue
552004-****	XL	bib and brace	space-blue

**NOREIN**<sup>®</sup>  
Ozon Deep Blue **WOMEN**

**FLEECE JACKET NORFIN OZON DEEP BLUE**

Warm and easy tailored women's jacket – suitable for outdoor activities. This universal jacket made of high quality fleece will keep your body warm and comfortable.

- ▶ Drawstring to tighten the jacket's lower part
- ▶ Front zipper
- ▶ Hood



ITEM NO.	SIZE (****)	DESCRIPTION
541200-****	XS	jacket
541201-****	S	jacket
541202-****	M	jacket
541203-****	L	jacket
541204-****	XL	jacket



**MATERIAL**  
**NORFLEECE THERMO**  
(100% POLYESTER)

**WINTER HAT NORFIN AVON DEEP BLUE**



ITEM NO.	SIZE (****)	DESCRIPTION	MATERIAL
305759**	M, L	with fleece insulation	100% Acrylic, 100% Polyester insulation

**SOCKS NORFIN**  
**TARGET WOMEN T1P**



ITEM NO.	SIZE	MATERIAL
303744-**	02M (35-37)	18% Polyester, 75% Acrylic, 5% Nylon, 2% Elastan
303744-**	03L (38-40)	18% Polyester, 75% Acrylic, 5% Nylon, 2% Elastan

**HAT NORFIN WOMEN**  
**NORDIC**

**WOMEN** **NEW**



**NORTEX**<sup>®</sup>  
breathable

ITEM NO.	SIZE (****)	DESCRIPTION	MATERIAL
305080-**	L, XL	Hat with earflaps Insulation: sintepon, artificial fur Lining: fleece	NORTEX Breathable 100% polyester

**MITTENS NORFIN WOMEN**  
**NORDIC**

**WOMEN** **NEW**



**NORTEX**<sup>®</sup>  
breathable

ITEM NO.	SIZE (****)	DESCRIPTION	MATERIAL
705080-**	L, XL	Breathable. Windproof. Reinforced palm area. Insulation: polyester Lining: fleece	NORTEX Breathable 100% polyester

# ICE DRILL REXTOR

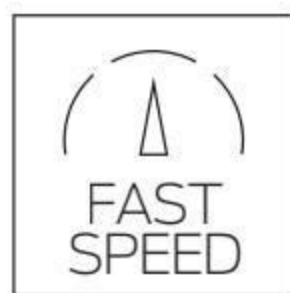

High speed drilling – standart angle of ice drill blades

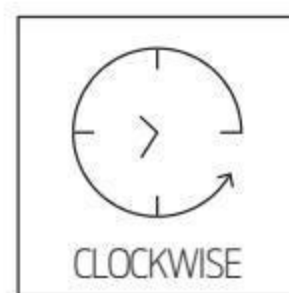

Anti clock wise drilling direction

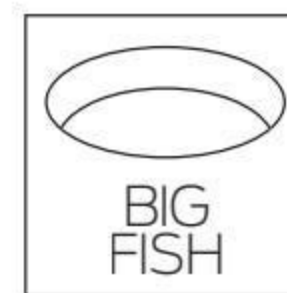

Ice drill with diameter of 150 mm



Clock wise drilling direction

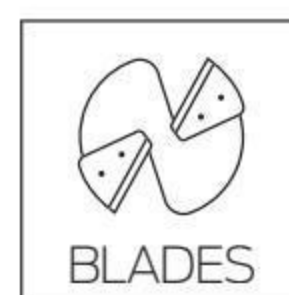

Minimal force while drilling

## ICE DRILL REXTOR BLAST

- ▶ high performance
- ▶ reliable welded construction
- ▶ one piece spiral
- ▶ forged blades that are easy to sharpen
- ▶ comfortable rubber coated grips
- ▶ high-quality anti-corrosion coating
- ▶ reasonable, affordable price for every angler

### TECHNICAL SPECIFICATIONS of REXTOR BLAST ICE DRILLS

ITEM NO.	DESCRIPTION	MODEL	Ø (MM)	WEIGHT (KG)	MAX. ICE (M)	TRANSP. LENGTH (M)	SCREW LENGTH (M)	FULL LENGTH (M)
RIB-130	foldable	BLAST	130	2,7	0,92	0,78	0,45	1,47
RIB-150	foldable	BLAST	150	3,3	0,92	0,78	0,45	1,47

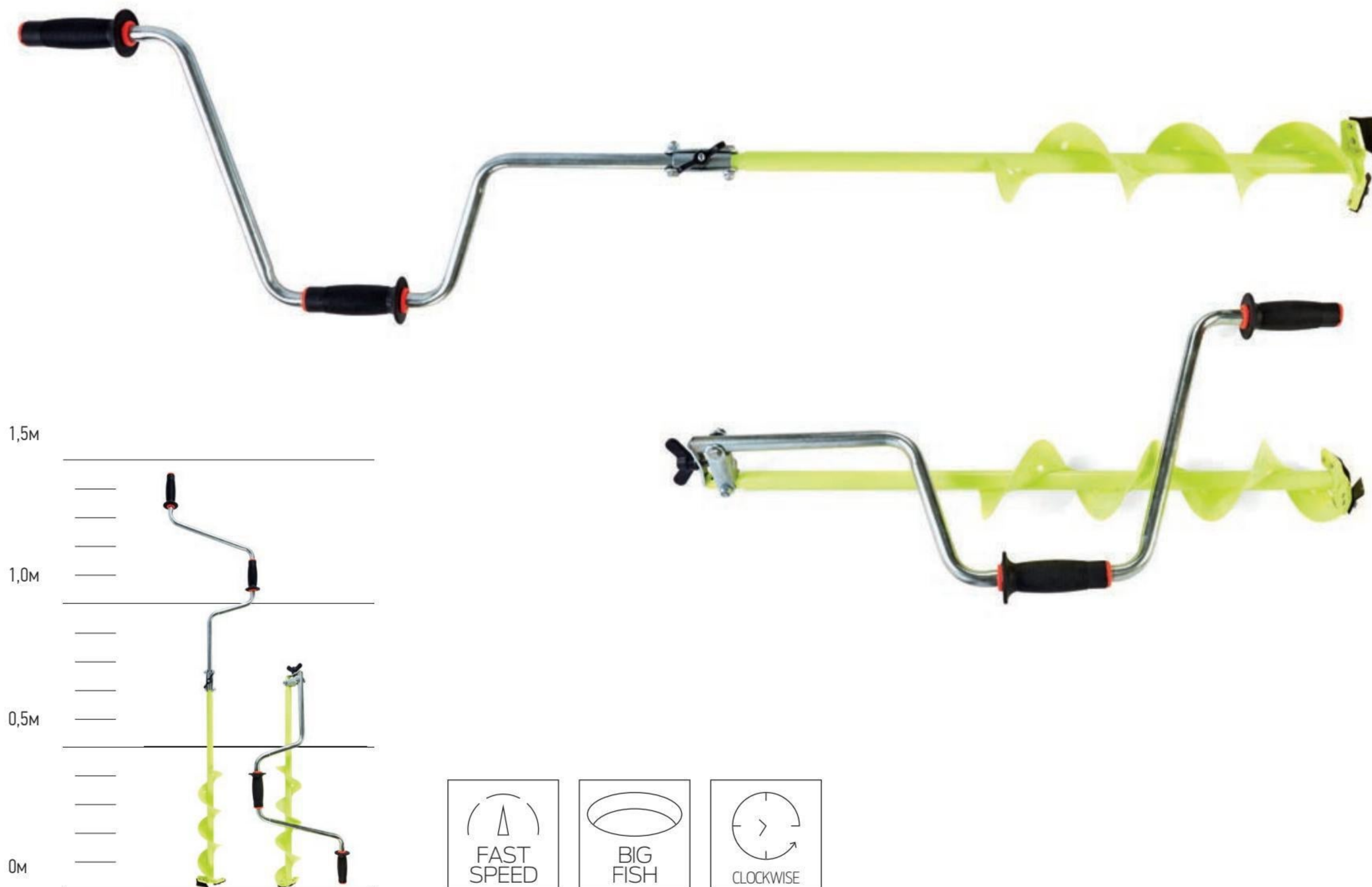

## ICE DRILL **REXTOR STORM**

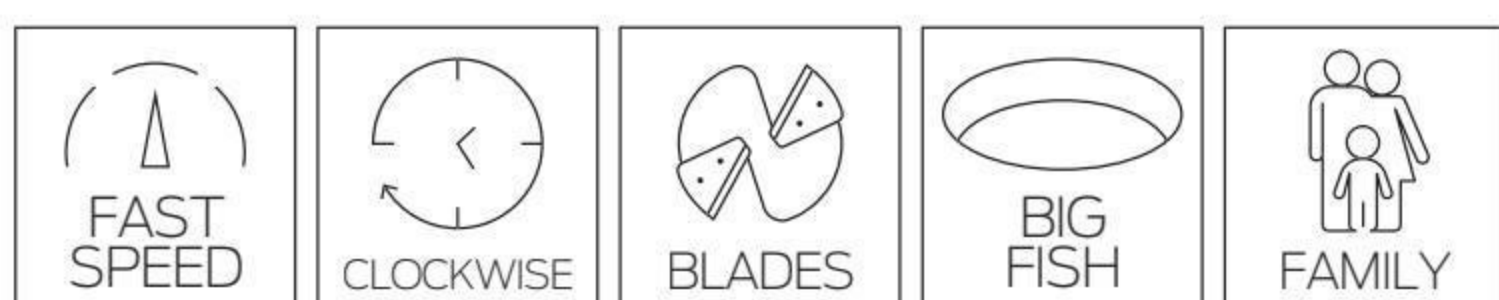
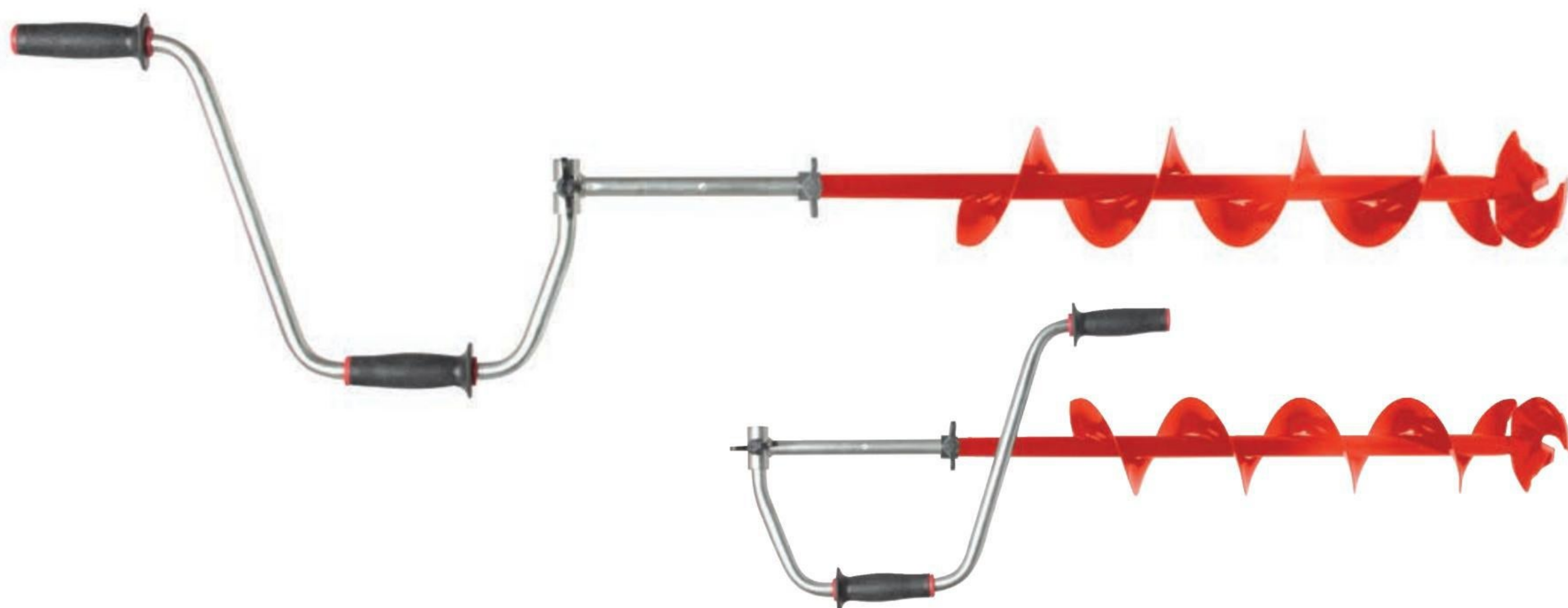

ITEM NO.	DESCRIPTION	Ø (MM)
RES-130	foldable, telescopic handle	130

## SPARE BLADES **REXTOR BLAST**



ITEM NO.	DESCRIPTION	Ø (MM)
RIB-B-130	BLAST	130

## SPARE BLADES **REXTOR STORM**



ITEM NO.	DESCRIPTION	Ø (MM)
RES-B-130	STORM and STORM LONG	130

## ADAPTER WITH HANDLE **REXTOR STORM**



ITEM NO.	DESCRIPTION
RSZ1-002	Adapter with handle



# MARKETING MATERIALS

## MARKETING MATERIALS AND CLOTHES

The products are recommended to experts, professional anglers participants of fishing festivals, as gifts to customers, for promotion activities in stores, for employees participating in exhibitions and other events.

### LUCKY JOHN T-SHIRT BLACK



ITEM NO.	SIZE	BRAND
R165M-BLK_***	S, M, L, XL, 2XL	LUCKY JOHN

### LUCKY JOHN SHIRT LONG SLEEVE RED



ITEM NO.	SIZE	BRAND
A115-RED_***	S, M, L, XL, 2XL	LUCKY JOHN

### NORFIN & LUCKY PRO TEAM SHIRT DIGITAL



ITEM NO.	SIZE	MATERIAL	BRAND
AM-7003-***	S, M, L, XL, XXL	100% polyester	LUCKY JOHN, NORFIN

### LUCKY JOHN POLO SHIRT



ITEM NO.	SIZE	MATERIAL	BRAND
AM-7501-	S, M, L, XL, XXL	60% cotton, 40% polyester	LUCKY JOHN

### LUCKY JOHN HOODY



ITEM NO.	SIZE	MATERIAL	BRAND
AM-8001-	S, M, L, XL, XXL	60% cotton, 40% polyester	LUCKY JOHN

## STAND NORFIN FOR GLASSES



ITEM NO.	CAPACITY, PCS
NF-ST2000	6

## ROD STAND LUCKY JOHN



ITEM NO.	CAPACITY, PCS
AM-345	24

## FOLDING CARDBOARD DISPLAY FOR HATS, GLOVES & SOCKS, THERMAL UNDERWEARE NORFIN



ITEM NO.	SIZE (MM)	MATERIAL
AM-170	650 x 1970	cardboard
AM-402	680 x 360 x 200	cardboard

## LUCKY JOHN METAL PRODUCT DISPLAY



ITEM NO.	SIZE (MM)	MATERIAL
AM-400	2500 x 1000	metal
AM-399-	1000 x 400	metal

## NORFIN BAG



ITEM NO.	BRAND
AM-269	Norfin

## PROMOTIONAL BAG LUCKY JOHN

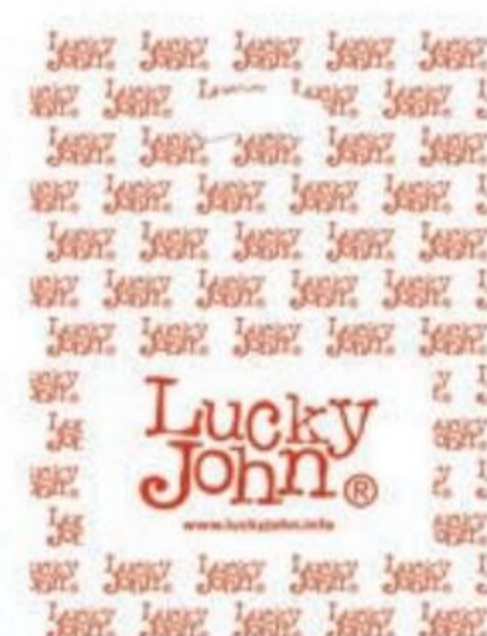

ITEM NO.	MATERIAL	SIZE (MM)
AM-250	polyethylene	297 x 405
AM-253	paper	240 x 270

# MARKETING MATERIALS

## LUCKY JOHN/NORFIN BASEBALL CAP



AM-6003



AM-6606



AM-6001



AM-6002

ITEM NO.	BRAND
AM-6001	Lucky John
AM-6002	Norfin
AM-6003	Feeder Concept
AM-6606	BBS

## BANDANA

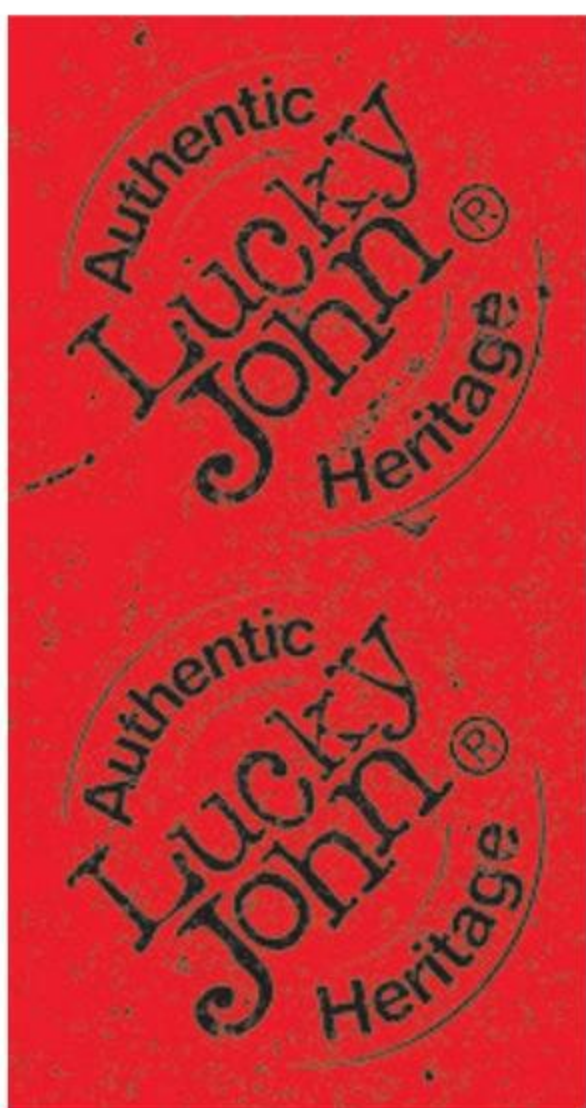

AM-122



AM-6501

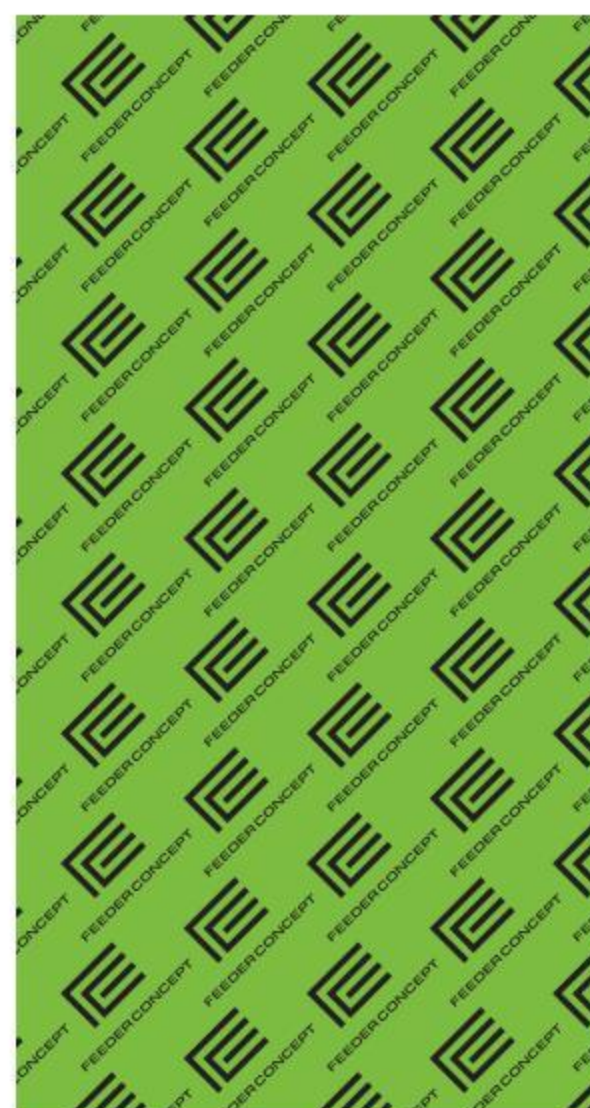

AM-6503



AM-6505



AM-6504

ITEM NO.	MATERIAL	BRAND
AM-6505	100% polyester	LUCKY JOHN
AM-6501	100% polyester	NORFIN
AM-122	100% polyester	LUCKY JOHN
AM-6503	100% polyester	FEEDER CONCEPT
AM-6504	100% polyester	NORFIN



## VERTICAL BEACH FLAG



ITEM NO.	BRAND	MATERIAL	COLOR	SIZE (CM)
AM-375	Feeder Concept	Polyester	Pantone C7496	80 x 340
AM-270	Lucky John	Polyester	Pantone 032 C	80 x 340
AM-171	Norfin	Polyester	Pantone CoolGray 7 C	80 x 340

## STICKER



ITEM NO.	BRAND	MATERIAL	COLOR	SIZE (MM)
STKR12	Lucky John	plastic	cmk	300 x 230
STKR13	Lucky John	plastic	cmk	85 x 65
STKR07	Norfin	plastic	cmk	300 x 200
STKR06	Norfin	plastic	cmk	85 x 85

## BANNER MESH UP



ITEM NO.	BRAND	MATERIAL	COLOR	SIZE (CM)
AM-180	Norfin	Banner cloth	Pantone CoolGray 7 C	300 x 200
AM-280	Lucky John	Banner cloth	Pantone 032 C	300 x 200

## STICKER A4 NORFIN / LUCKY JOHN / FEEDER CONCEPT

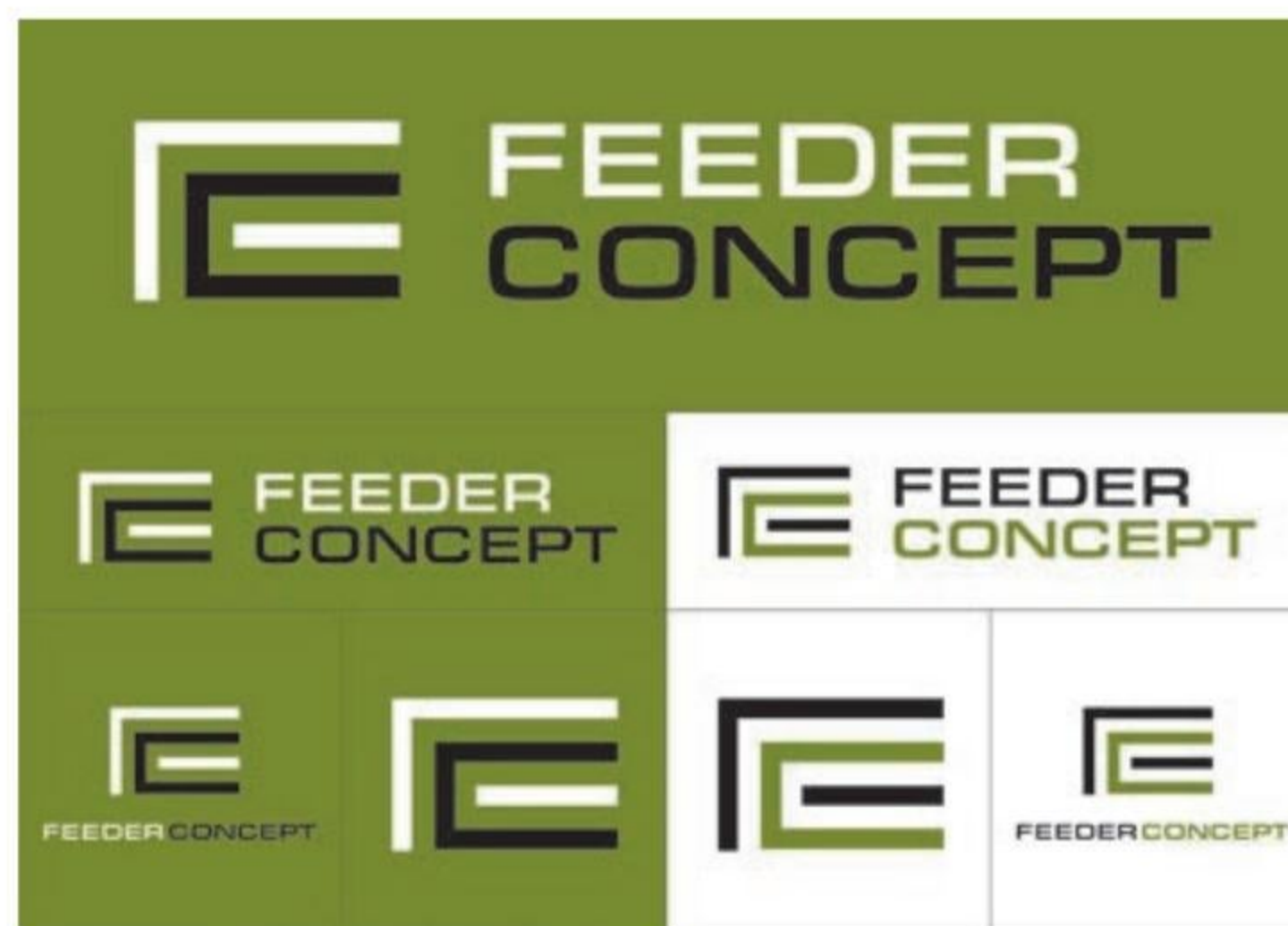
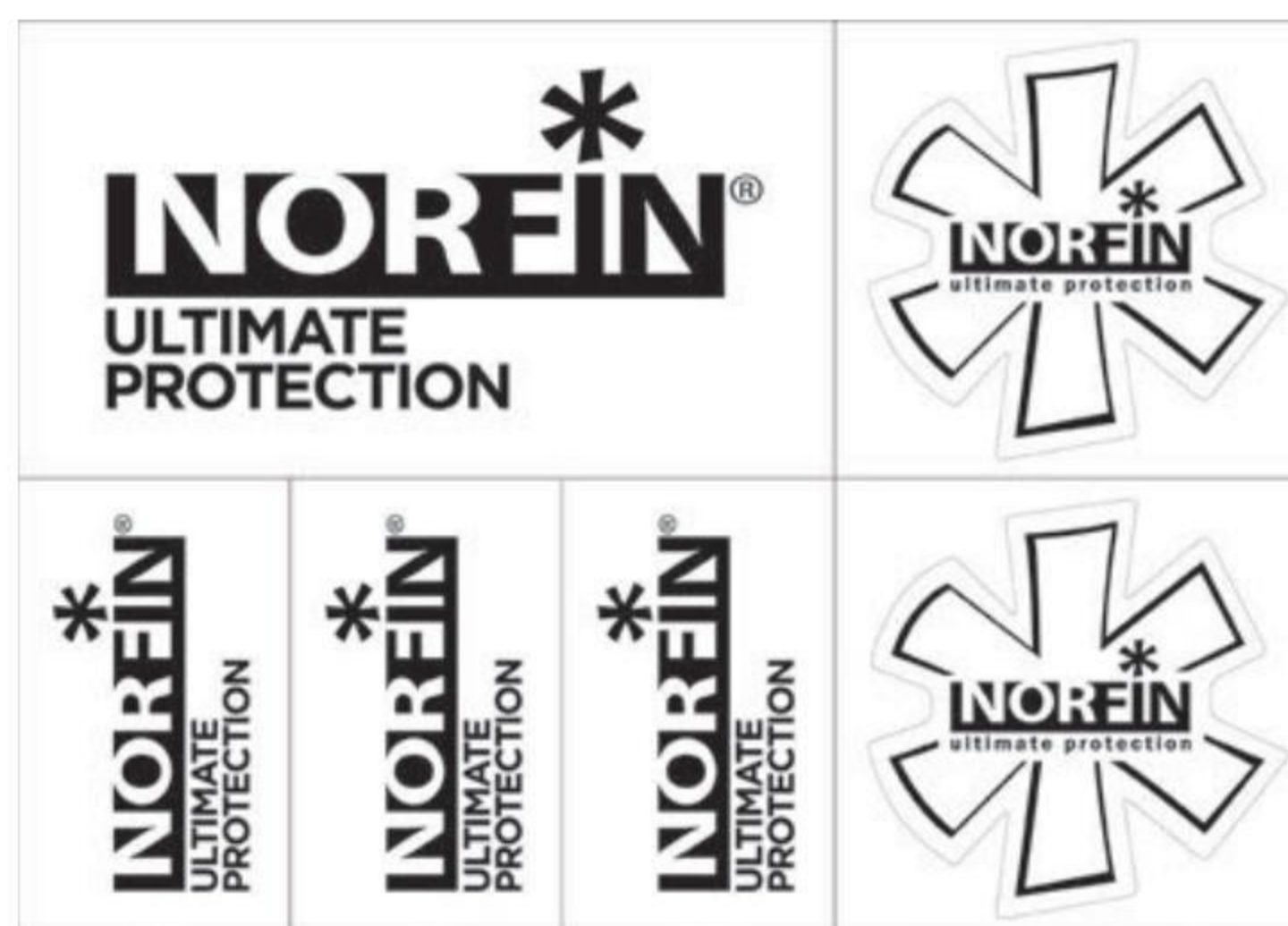

ITEM NO.	BRAND	MATERIAL	COLOR	SIZE (MM)
AM-190	Norfin	plastic	Black	210 x 297
AM-290	Lucky John	plastic	Pantone 032C	210 x 297
AM-395	Feeder Concept	plastic	Pantone C 7496	210 x 297





**LUCKY JOHN EUROPE LTD**

Latvia

Tel. +371 26550029

[sales@luckyjohn.info](mailto:sales@luckyjohn.info)

**LUCKY JOHN SUOMI OY**

Finland

Tel. +358 40 5311800

[sales@luckyjohn.info](mailto:sales@luckyjohn.info)

**LUCKY JOHN USA LLC**

USA

[usa@luckyjohn.info](mailto:usa@luckyjohn.info)

[www.luckyjohn.info](http://www.luckyjohn.info)

[www.norfin.info](http://www.norfin.info)